

# CATALOGUE OF CASE STUDIES

*Road safety improvements relevant to Vulnerable Road Users, Human Factors and Low- and Middle-Income Countries*

**TECHNICAL COMMITTEE C.2 DESIGN AND OPERATION OF SAFER ROAD INFRASTRUCTURE**



# STATEMENTS

*The World Road Association (PIARC) is a nonprofit organisation established in 1909 to improve international co-operation and to foster progress in the field of roads and road transport.*

*The study that is the subject of this report was defined in the PIARC Strategic Plan 2016– 2019 and approved by the Council of the World Road Association, whose members are representatives of the member national governments. The members of the Technical Committee responsible for this report were nominated by the member national governments for their special competences.*

*Any opinions, findings, conclusions and recommendations expressed in this publication are those of the authors and do not necessarily reflect the views of their parent organisations or agencies.*

*This report is available from the internet site of the World Road Association (PIARC): <http://www.piarc.org>*

*Copyright by the World Road Association. All rights reserved.*

*World Road Association (PIARC)  
Arche Sud 5° niveau  
92055 La Défense CEDEX, FRANCE*

*International Standard Book Number: 978-2-84060-604-8*

*Front cover © Slovenian Infrastructure Agency*

# **CATALOGUE OF CASE STUDIES**

*Road safety improvements relevant to Vulnerable  
Road Users, Human Factors and Low- and Middle-  
Income Countries*

**TECHNICAL COMMITTEE C.2 DESIGN AND OPERATION  
OF SAFER ROAD INFRASTRUCTURE**

## AUTHORS/ ACKNOWLEDGEMENTS

This report has been prepared by the Technical Committee C.2 Design and Operation of Safer Road Infrastructure (2016-2019). The work is based on a collection of case studies in which were considered road safety improvements that include Vulnerable Road Users (VRU) safety improvements, countermeasures based on Human Factors' principles (HF), and examples of countermeasures that can be implemented in Low- and Middle-Income Countries (LMIC).

The activities have been carried out by three Working Groups (WGs): WG C.2.1 Vulnerable Road Users, WG C.2.2-3 Human Factors and design & Setting Credible Speed Limits and WG C.2.4-5 Catalogue of design, operations and maintenance safety problems and potential countermeasures for LMIC & Road Safety Audit guidelines.

The contributors to the preparation of this report are presented below in alphabetical order:

- Carlos Almeida Roque (Portugal)
- Per Andersson (Sweden) – WG C 2.1 Deputy Leader
- John Barrell (United Kingdom) - WG C2.4-5 Leader
- Sibylle Birth (Germany) – WG C2.2-3 Leader
- Xavier Cocu (Belgium)
- Raducu Dinu (Canada)
- Marion Doerfel (Switzerland)
- Lorenzo Domenichini (Italy) – WG C2.2-3 Deputy Leader (Human Factors)
- Lise Fournier (Canada-Québec)
- Antonio Granado Pérez (Spain)
- Matthieu Holland (France)
- Jaakko Klang (Finland)
- Bernhard Lautner (Austria) - WG C2.2-3 Deputy Leader (Setting Credible Speed Limits)
- Steven Robertson (South Africa) - WG C2.4-5 Deputy Leader
- Gerhard Schuwerk (Switzerland)
- Raziah Binti Wahab (Malaysia)
- Mathias Wärnhjelm (Sweden) – WG C2.1 Leader

Also contributed to this report:

- Monica Meocci (Italy)
- Andrea Paliotto (Italy)
- Dominik Schmitt (Germany)

The editors of the report are:

- Raducu Dinu (Canada)
- Andrea Paliotto (Italy)

Final review and quality control of the English version of the report by:

- Carlos Almeida Roque (Portugal)
- Sibylle Birth (Germany)



- Evan Coulson (Australia)
- Yoshiyasu Murashige (Japan)

Committee C.2 Design and Operation of Safer Road Infrastructure (2016-2019) chairman and secretariat are:

- Chair: Shaw Voon WONG (Malaysia)
- English-speaking Secretary: WICKHAM Lucy (United Kingdom)
- French-speaking Secretary: HOLLAND Matthieu (France)
- Spanish-speaking Secretary: Alberto MENDOZA DÍAZ (Mexico).

### **Case study authors**

The case studies were provided by participants that are not necessarily part of the PIARC organization.

Their names are mentioned at the end of each case study, typically being the “Contact names”. This catalogue could not be realized without their contribution and the authors of this report acknowledge their valuable participation.

Each author of a case study selected to be included in this PIARC report, declares that the opinions, findings, conclusions and/or recommendations expressed in that case studies, are theirs and do not necessarily reflect the views of his parent organization or agency.

Finally, the authors of this report do not necessarily endorse the opinions and have not conducted their own research to confirm the findings, conclusions and/or recommendations presented in the case studies.

2019R47EN

## ROAD SAFETY - CATALOGUE OF CASE STUDIES

Knowledge comes from the analysis of successes and un-successes. Case Studies collection represents an important step toward the construction of knowledge.

PIARC Case Studies Catalogue contains the description of a set of interventions designed, implemented and operated worldwide to improve road safety in three specific fields: Vulnerable Road Users (VRUs), Human Factors (HF) and interventions in Low- and Middle-Income Countries (LMICs). Some of them are examples that already proved to be effective in increasing road safety, others are interventions implemented to solve a specific safety problem that in the future years will prove their effectiveness, other are projects designed to face an identified problem, others are conceptual solutions.

The PIARC Case Studies Catalogue is realized to be enriched in the future with new case studies, showing other applications, different solutions to solve the same problems and better representing the safety interventions applied or applicable in LMICs. It should be also implemented with the addition of future proves concerning the safety impact of the case studies included in the first edition.

A Case Studies Catalogue form a sort of data base available for future post-processing and analysis aimed at identifying best practices once the effectiveness of the described solutions will become clear in future, enriching the existing safety engineering culture.

In the meanwhile, the PIARC Catalogue of Case Studies represents an added value for practitioners and engineers involved in managing and maintaining the existing road network. Looking at how one safety problem has been solved elsewhere, their capacity to identify the most suitable solution to be tailored to their specific traffic and environmental conditions could increase, growing the awareness of road safety.

The report contains a first part where the procedure followed by the WG for the collection of the case studies is presented. Furthermore, some statistics are given about the case studies, followed by three specific paragraphs, one for each topic (VRU, HF, LMIC), where general discussions are presented about the possible countermeasures and a key of lecture is given in order to better go through the reading of the presented case studies.

The report can be used by road engineers and National Road Authorities (NRAs) to assist in designing cost-effective countermeasures where problems exist on the road network.

# CONTENTS

<b>1. INTRODUCTION</b> .....	<b>3</b>
<b>2. COLLECTION OF CASE STUDIES</b> .....	<b>5</b>
2.1. EFFECTIVENESS OF DESCRIBED COUNTERMEASURES .....	9
<b>3. VULNERABLE ROAD USERS</b> .....	<b>10</b>
3.1. RELEVANCE OF VULNERABLE ROAD USERS IN ROAD SAFETY.....	10
3.2. DEFINITION.....	11
3.3. SOLUTIONS ORIENTED TOWARDS THE DRIVER (CATEGORY 1) .....	15
3.4. SOLUTIONS ORIENTED TOWARDS THE VRU (CATEGORY 2) .....	16
<b>4. HUMAN FACTORS</b> .....	<b>17</b>
4.1. OPTICAL GUIDANCE .....	17
4.2. SPATIAL PERCEPTION .....	18
4.3. DRIVERS' EXPECTATIONS .....	19
<b>5. LOW- AND MIDDLE-INCOME COUNTRIES</b> .....	<b>21</b>
5.1. DETERMINATION OF KEY AREAS FOR CASE STUDIES .....	21
5.2. WORK ZONE ARRANGEMENTS .....	21
5.3. DEALING WITH RURAL CORRIDORS .....	22
5.4. SUBURBAN SITUATIONS WHERE DEVELOPMENTS ARE PROGRESSED IN ISOLATION .....	23
5.5. DEALING WITH URBAN MOTORCYCLES .....	23
5.6. TREATING LINEAR SETTLEMENTS.....	25
5.7. DEALING WITH UN-REGULATED PUBLIC TRANSPORT .....	26
<b>6. CASE STUDIES</b> .....	<b>28</b>
6.1. VULNERABLE ROAD USERS CASE STUDIES .....	28
6.2. HUMAN FACTORS CASE STUDIES .....	176
6.3. LOW- AND MIDDLE-INCOME COUNTRIES CASE STUDIES .....	350
<b>7. CONCLUSIONS</b> .....	<b>381</b>
<b>8. REFERENCES</b> .....	<b>382</b>
<b>9. GLOSSARY</b> .....	<b>385</b>

## 1. INTRODUCTION

In the period 2016-2019, PIARC TC C.2 decided to work on the theme of road safety improvements relevant to “Vulnerable Road Users” (VRU), “Human Factors” (HF) and “Safety problems and potential countermeasures for Low- and Middle-Income Countries” (LMIC). This included the preparation of a “Catalogue of Case Studies” that would be useful to road designers, engineers, technicians or administrators who are involved in the improvement of road safety.

This report deals with the presentation of 68 case studies provided by 21 countries and describes situations in which a safety problem was caused by an incorrect interpretation of the road environment, a misunderstanding by the driver or an unexpected feature of the road and traffic conditions. In many situations, the road environment has confused the driver and prevented the intended reaction from taking place. Consequently, the operational error has resulted in a possible driving mistake and led to a collision occurring. This catalogue of case studies describes how these problematic situations were solved by means of targeted countermeasures, aimed at eliminating or reducing the misleading environment created by the road.

Describing and discussing case studies is a valuable way to demonstrate the relevance of various road safety countermeasures and to provide a solid database for subsequent investigations. This report, by the others, could provide an added value to the on-line Road Safety Manual [1]. Sharing case studies helps road safety auditors and inspectors to tackle with a great variety of problems [2] [3] [4].

The topics considered in this Report include:

Vulnerable Road Users (VRU); which is still an unsolved or ongoing road safety problem. Despite the many efforts that have been made in the last decade, including the generally positive results from driver safety, data shows that vulnerable road users are benefiting less from road safety treatments (for detailed information see also PIARC document [1]);

- **Human Factors (HR)**; a topic that has been increasingly considered within design, road safety intervention and analysis. This subject is necessary when defining road safety improvements based on a pro-active approach, whose objective is to prevent the occurrence of driving mistakes rather than reacting to the accident consequences (for detailed information see also PIARC document [2]);
- Solutions and possible interventions applicable in **Low- and Middle-Income Countries (LMIC)**; building on the experience of High Income Countries. The background information concerning these countermeasures is included in the PIARC document *Catalogue of design safety problems and potential countermeasures* [1], to which reference should be made for more detailed information. It is recognized, however, that in many LMICs road user behaviour and a poor level of enforcement remain the biggest challenges in improving road safety.

All case studies collected have been grouped into these three topics according to their main interest, even if they had transversal relevance (relevant to more than one topic). This Catalogue is organized into three parts, each part devoted to one of the selected topics.

It is intended that this document will be added to in the future, with updated information regarding the treatment evaluation and with the description of new case studies, to provide an extensive

catalogue of relevant case studies to illustrate the application of Safe System approach described in the PIARC Road Safety Manual.

## 2. COLLECTION OF CASE STUDIES

In 2017, an international survey was launched by the PIARC General Secretary, requesting case studies relevant to the following road safety topics; Vulnerable Road Users, Human Factors, Setting Credible Speed Limits and Safety Countermeasures for LMIC.

To collect the case studies, a 5-steps procedure was applied:

**Stage 1 – Determining which areas were most relevant to each safety issue.** This included a thorough review of the PIARC *Catalogue of design problems and potential countermeasures* [7], to identify any areas in which additional case studies would be most beneficial.

**Stage 2 – Collecting case study proposals.** At this stage, case studies were collected with just general information: the main features, a short description and some descriptive material (photos or similar).

**Stage 3 – Choosing the most relevant case studies.** Each proposed case study was carefully analysed and the case studies that appropriately addressed either topic were selected, and additional information were requested in order to create a complete case study proposal.

**Stage 4 – Collecting more detailed information about the chosen case studies.** The additional information required concerned the description of the safety problem, the proposed solution, the justification used to support the treatment and any validation or safety evaluation completed on the implemented treatment.

**Stage 5 – Drafting the report.**

It is noted that all case studies attached within this report reflect the ideas of their Authors and do not necessarily reflect the views of PIARC TC C.2 WGs members. Nevertheless, all case studies were analysed and are considered appropriate for the identified topics.

At the end of stage 4, a total of 68 case studies were selected for the catalogue.

As shown in Graph 2.1, many countries contributed their case studies. Figure 2.1 highlights the countries in a world map, showing that case studies were received from all over the world. China, Italy and Spain each provided eight studies. Relatively few case studies were received from South America, Africa, Asia and Australia. This will be addressed in future upgrades of the catalogue.



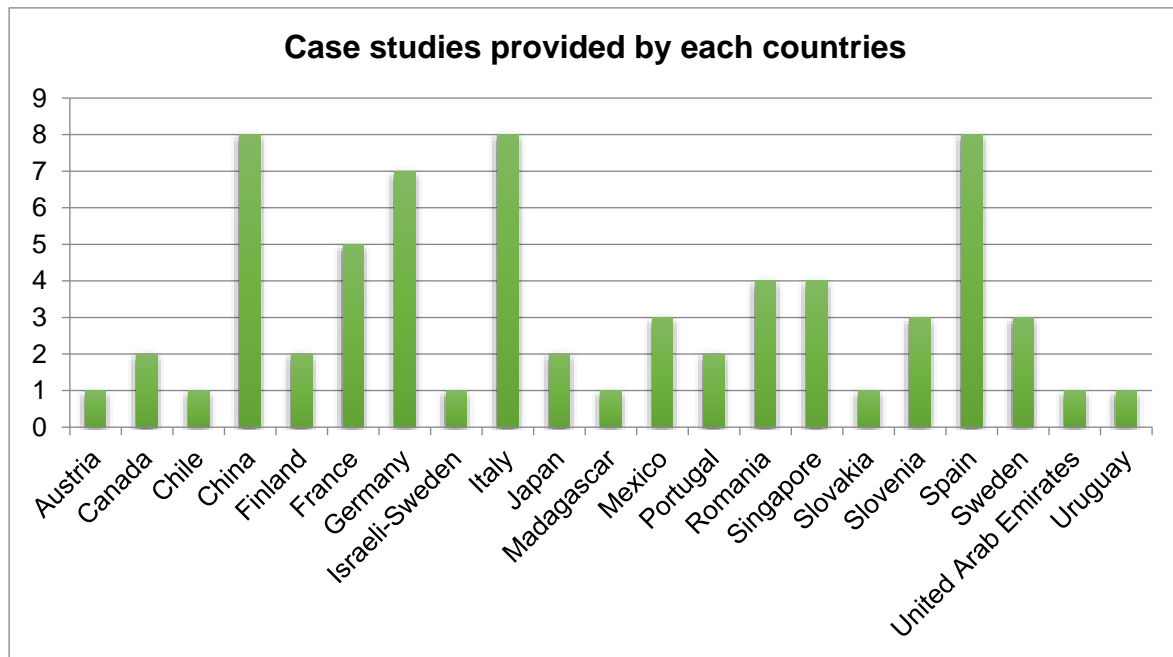

Graph 2.1 - Number of case studies provided by each country



Figure 2.1 - Countries (in blue) that provided the case studies

The analysis carried out in stage 3 highlighted that many of the countermeasures reported in the case studies can be associated to more than one safety topic. For example, improving a pedestrian crossing by making it visible to drivers from distance, is a safety measure that improves the safety of the VRUs by improve the Human Factors features (optical guidance) of the road.

The following table provides the entire list of case studies available in the Catalogue (sorted by country), specifying which are the safety topics addressed.

The detailed description (stage 4) of each case study is reported in chapter 6 under the heading of the main addressed safety topic.

N.	Name/Title	Country	Topic Addressed		
			VRU	HF	LMIC
1	Additional Marking for Powered Two Wheels	Austria	x	x	
2	Infrastructure Modification, Montebello	Canada	x	x	
3	Speed and access management with pedestrian facilities, Shawville	Canada	x	x	
4	Road Safety in Rural School Areas	Chile	x	x	
5	A case study of adding LED lighting facilities for crosswalk	China	x		
6	A case study of color wide solid center line	China		x	
7	A case study of improving of visibility	China			x
8	A case study of separation of two-way traffic flow	China			x
9	A case study of Setting a large reduction mound on the crosswalk	China	x	x	
10	A case study of the optimization of the planar cross canalization	China	x		
11	Guizhou province anshun city X462 road	China		x	
12	Setting of dimension stone pavement on highways through village	China			x
13	Wrong way driving on motorway E18 Halikko ramp, Salo	Finland		x	
14	Wrong way driving on motorway E18 Pappila ramp, Salo	Finland		x	
15	AudioTactilesSystems-RunOffRoad-DrivingSimulator	France		x	
16	AudioTactilesSystems-RunOffRoad-InSitu	France		x	
17	Experimentation of a modification of the signalisation layout by Flashing directionnal arrows (FLR)	France		x	
18	Kinematics of powered two-wheelers (PTW) at bends on intercity roads	France	x		
19	Visual Information Infrastructure	France		x	
20	Brandenburg	Germany	x		
21	Cottbus	Germany	x		
22	Erfurt	Germany	x		
23	Human Factors Countermeasures in a fatal accident curve	Germany	x		
24	Schwetzingen	Germany	x		
25	Stralsund	Germany	x		
26	Wehr	Germany		x	
27	Design of crosswalks for children	Israeli-Sweden	x		
28	Crosswalk removal	Italy	x		
29	Dangerous School Crosswalk because of high traffic	Italy	x	x	
30	Optical Illusion in a Collector Road Tunnel	Italy		x	
31	Realization of a well-respecting 20 km/h Zone, Lignano Sabbiadoro	Italy	x	x	
32	Safety Intervention on a Junction	Italy	x		
33	School Crosswalks with low visibility + Sidewalk Advancement	Italy	x		
34	Speed Management in Motorway Work Zone Crossover	Italy		x	
35	Speed Reduction Schemes on Urban Collector Road	Italy	x	x	
36	Installation of "Soft" Rising Bollard to eliminate through traffic from school route	Japan	x		

37	Sequence design of the internal space of the tone suppressing speed excess	Japan		x
38	Proposals for Potential Countermeasures in LMICs	Madagascar	x	
39	Emergency braking ramp on roads and highways	Mexico		x
40	Road Safety Inspection of Highway MEX-057	Mexico	x	
41	Road Safety Inspection of the Free Federal Highway Mexico-Toluca	Mexico	x	
42	LCEM on a dangerous trunk road: Markings and Signings	Portugal		x
43	Low Cost Engineering Measures on a dangerous trunk road: Perceptual treatment	Portugal		x
44	Arranging a pedestrian crossing on DN 28, in Valea Lupului, Iași county	Romania	x	x
45	Re-arrangement of a pedestrian crossing on DN 28, in Bălțați, Iași county	Romania		x x
46	Re-arrangement of a pedestrian crossing on DN 28, in Bălțați, Iași county	Romania	x	x
47	Arrangement of a turning point for vehicles at DN 28 km 65 + 400, in Valea Lupului locality, Iași county	Romania		x
48	Building wider and dedicated cycling paths to segregate pedestrians and cyclists	Singapore	x	
49	Changing the Character of Roads within Silver Zones to lower speed limits	Singapore		x
50	Introducing Broader Alignment Lane Markings	Singapore		x
51	Introducing Traffic Calming Markings (TrCM)	Singapore		x
52	Bad layout parameter	Slovakia		x
53	Calming measure in town Podturn	Slovenia		x
54	Credible speed limit in Zone 30	Slovenia	x	x
55	Safer Way to School	Slovenia	x	x
56	Construction of elevated pedestrian walkways or underpasses	Spain	x	
57	Correction of alignment perspectives	Spain		x
58	Countermeasures in areas with risk of rear end collisions	Spain		x
59	Narrowing of lanes in areas of reduced speed (crossings, etc.)	Spain		x
60	Protected Cycling Routes	Spain	x	
61	Segregated cycle paths from the main traveled way	Spain	x	
62	Signing and delineation of curves	Spain		x
63	Visibility improvements at intersections	Spain		x
64	Bicycle passages and bicycle crossings	Sweden	x	
65	Evaluation of use of salt (NaCl) and sweep of snow on bicycle lanes	Sweden	x	
66	Warm wetted sand for skid control of walkways and bike paths	Sweden	x	
67	New Road Marking in the Federal Roads	United Arab Emirates		x
68	Treatment of route 9 corridor	Uruguay		x

Table 2.1 – Presented case studies

## 2.1. EFFECTIVENESS OF DESCRIBED COUNTERMEASURES

Many (but not all) case studies include the description of the activities performed to evaluate the effectiveness of the implemented safety countermeasure. Out of 68 collected case studies:

- 43 cases (63%) include the evaluation of the effectiveness by means of before-after study;
- in 3 cases (4.5%) the effectiveness was evaluated by means of studies in virtual reality (driving simulation studies);
- in 1 case (1.5%) an evaluation survey was launched and
- in 21 case studies (31%) no effectiveness study has been referred to.

Out of the case studies for which an effectiveness study is referred to and considering the transversal reference:

- 47% tackles VRUs safety problems;
- 62% tackles HF and
- 13% refers to LMIC

Future upgrades of the catalogue should add the confirmation of the proven effectiveness of the evaluations, at present missing.

### 3. VULNERABLE ROAD USERS

#### 3.1. RELEVANCE OF VULNERABLE ROAD USERS IN ROAD SAFETY

Vulnerable Road Users (VRUs) include those with the greatest risk of injury because of their insufficient physical protection and their relative speed difference with conflicting transport modes. VRUs can be divided into four main user categories: pedestrians, cyclists, riders of powered two-wheelers (referred to as motorcyclists) and light duty farm vehicles or animal drawn vehicles [2].

Half of all road fatalities are VRUs: motorcyclists (23%), pedestrians (22%) and cyclists (4%) [2], therefore the share of VRUs that become victims of road traffic, is of particular concern [3].

Treating the VRU safety issue is extremely difficult and is different in each country given the context. There is a long list of safety treatments already available in current literature. However, data shows that VRUs are benefiting less from typical road safety improvements. In addition, road safety policies have not been successful in improving protection for vulnerable road users. The latest available data shows that reductions in road deaths among pedestrians, cyclists and motorcyclists have leveled off since 2009/10 and in some cases, increases have been recorded [4].

The rate of deaths involving VRUs is very different throughout the world. The African region has the highest proportion of pedestrian and cyclist deaths - 43% of all road traffic deaths - while these rates are relatively low in the South-East Asia region (see Figure 3.1). This partly reflects the level of safety measures in place to protect different road users and the predominant forms of mobility in different regions [2].

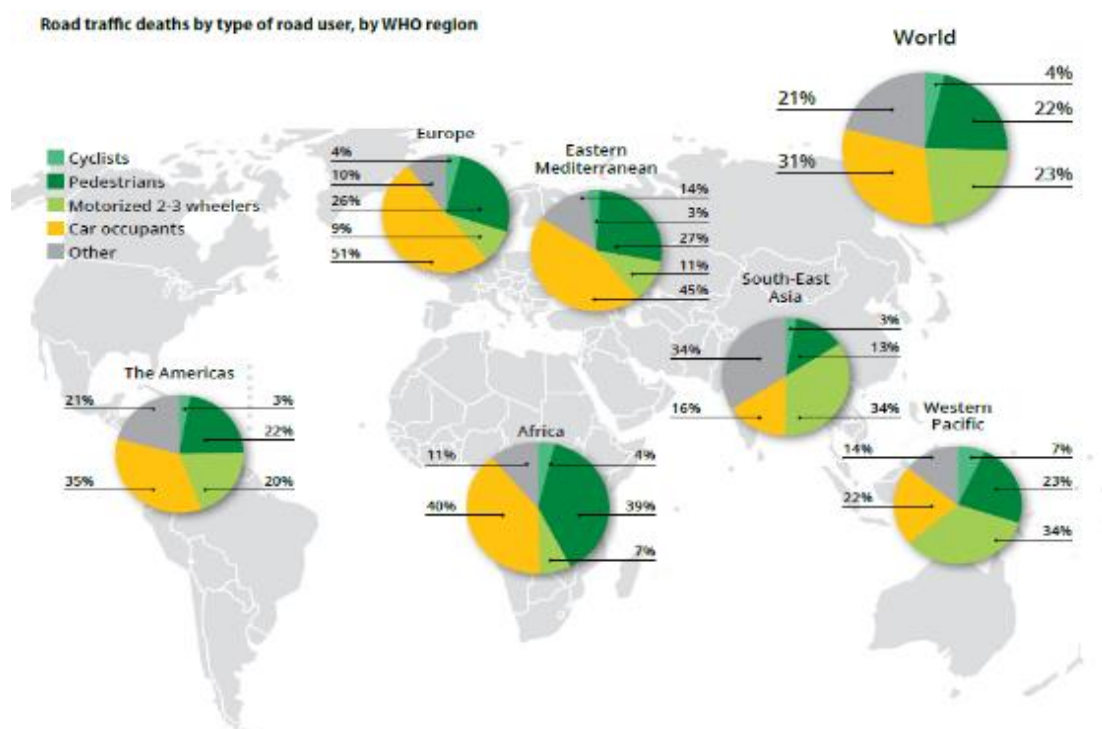

Figure 3.1 – death by road users' category (PIARC, 2009)

In fact, the highest number of all road related deaths occur in low-income countries, where the fatality rate is more than double those in high-income countries. This creates a very disproportionate number of deaths relative to the countries' level of motorization.

In most countries, more than half of the VRU road deaths occurred in urban areas, where there is often dedicated infrastructure (e.g. pedestrian crossings) or where they are permitted without any intervention [5]. It is for this reason, that dedicated action is required to ensure safer mobility in urban environments; a task that is being undertaken by the new 'Safer City Streets' network of cities created by the International Transport Forum [3].

If we are to remedy the situation, or at least build a strategy that reduces the number of VRU deaths, then we must change the approach of many road engineers and National Road Authority (NRA), by encouraging the use of countermeasures that improve safety for all road users.

There is an extensive library of literature available on the issues involving VRU safety and the relationship between VRUs and the built environment. These publications provide an overview of the effectiveness of different safety treatments. The monitoring of safety treatments carried out to improve safety for VRUs, represent an important source which may be used for decisions by engineers and planners [4].

Nowadays there are a number of countries (mostly high-income) that have already changed their approach to this problem, by implementing corrective measures that improve road safety and accessibility. Among these, the nations of northern Europe can be aspired to as a starting point for countries with a growing problem, or for those countries in which the VRUs accident rate must not be neglected.

This report provides useful elements in order to identify the main issues involving VRUs. Furthermore, this document has been created to suggest possible intervention and countermeasures to mitigate VRU safety risks.

The corrective actions, including education, enforcement and engineering actions shown in detail aim to reduce both the likelihood and severity of VRU crashes.

The report gives examples of unsafe problems for VRUs, suggests a range of methods to overcome these and gives an indication of the relative costs to facilitate prioritisation of the work. Photographs have been provided where possible to better describe the intervention.

The report can be used by road engineers and National Road Authorities (NRAs) to assist in designing cost-effective countermeasures where problems exist on the road network.

Most of the case studies come from interventions already implemented on roads in High Income Countries (HIC). Cost and implementation issues have also been addressed during the process.

The use of infrastructure interventions to help manage safety and reduce the likelihood of a crash (for example road widening or raised pedestrian crossings), and interventions to mitigate the severity of the crash can be used fruitfully by technicians and NRAs along road infrastructure.

### **3.2. DEFINITION**

Walking and cycling are transport modes that force relatively unprotected road users to interact with vehicular traffic of high speed and mass. This makes pedestrians and cyclists vulnerable. They suffer the most severe consequences in collisions with other road users because they cannot protect themselves against the speed and mass of the other party.



While pedestrians and cyclists are typically included in the VRU definition, other types of road users should also be considered.

Compared to cars, powered two-wheelers (PTWs) are less stable, less visible and of course a moped or a motorcycle offers much less protection to the rider than other motorized vehicles. All around the world, motorcyclists are involved in a disproportionately high percentage of fatal and serious crashes. This makes motorcyclists vulnerable, notwithstanding the fact that they can be as much of a threat to pedestrians and cyclists because of their speed.

Similarly, small agriculture vehicles and animal drawn vehicles often experience severe consequences in collisions with motorized traffic, due to speed differences, inadequate visibility (mostly at night) and because of their low level of protection.

The vulnerability of road users may also be attributed to their level of task capability (limitations in performing one or more task aspects) or even to their resilience to accidents (capability to quickly recover). However, even if novice drivers (limited task capability) or elderly car drivers (also low resilience) may also be considered as vulnerable, In this report it is decided to concentrate on the most vulnerable users first because of insufficient physical protection or because of relative high speed difference with potential conflicting modes [2].

Similarly, and even if everybody agrees that road workers can be considered vulnerable (based on the criteria mentioned above) this user type in its current work is excluded from the definition. Addressing safety issues related to road workers usually needs specific measures that are already addressed [6].

Consequently, the following definition has been used in this report and will be used in any upcoming work with vulnerable road users:

The “vulnerable” road users are those road users who are at greatest risk because of insufficient physical protection or because of relative high-speed difference with potential conflicting modes.

Even if various criteria, like the level of task capability or the ability to recovery, may impact the vulnerability of vehicle occupants, **Pedestrians, cyclists, riders of powered two-wheelers, as well as light duty farm vehicles or animal drawn vehicles** are more particularly vulnerable [2].

Additional factors should be considered when looking at infrastructural measures to mitigate the risk faced by VRUs:

- In certain circumstances, vulnerable road users may themselves be a threat to others; e.g. PTWs or even cyclists at higher speeds may be dangerous for other VRUs;
- The fatalities amongst vulnerable road users are usually higher in low and middle-income countries (LMICs) - due to a lack of resources to provide or maintain adequate and safe infrastructure, land use planning problems (e.g. linear settlements), and sometimes unsafe user behaviour;
- LMICs also have more instances of mixed traffic conditions; including slow-moving and vulnerable non-motorized road users, as well as motorcycles, mixed with fast-moving motorized vehicles.

The provision of VRU facilities does not guarantee effective usage and compliance by VRU and drivers. Although this report provides valuable infrastructure safety treatment to mitigate risks,

education and publicity programmes are needed to improve understanding and awareness while enforcement can help motivate desirable behaviour patterns [2].

In this respect, the VRU design solutions are focused on two main categories:

- Solutions oriented towards vehicles drivers in order to limit the severity of the traffic conflict with the VRUs;
- Solutions oriented towards the VRUs themselves.

In the first category, the solutions follow a Human Factors (HF) approach (as described in the following chapters) by creating a logical layout of the road, an adequate time to react and enough visibility for the drivers to a VRU road conflict hence providing a safer environment for VRUs. Other solutions in this category are related to speed management of vehicles, such as traffic calming measures. Refer to PIARC Road Safety Manual [1] (Part III, Chapter 8 Design for Road Users Characteristics and Compliance) for more details.

In the second category, solutions often provide separation and/or safer VRUs layouts in proximity to the main road alignment or when in conflict with vehicular traffic. These solutions range from physical separation (dividing roads), dedicated lanes and paths for pedestrian and cyclists to the removal of conflict points between VRUs and other vehicles (e.g. dedicated crossing areas or above/under-ground pedestrian passages). This category also includes solutions based on speed management (this time focused on VRUs such as bicycles) in proximity to the vehicular traffic conflict and measures to control the physical characteristics of the dedicated VRUs paths are also included in this category.

The following illustration gives an example where a combination of both categories is utilized to provide a safer conflict management between the vehicles and VRUs (pedestrians and bicycles) as follows:

- Speed Management (SM) devices for vehicles: vertical displacement of the road alignment (humps) and road narrowing with islands;
- Speed Management device for bicycles: lateral displacement (chicane) on the bicycle path;
- Driver HF: visibility and time to react (signing and pavement marking);
- Physical characteristics of the VRUs paths: alignment and pavement surface with reduces/no irregularity.



*Figure 3.2 – Example of a mix of protecting VRUs measures when crossing path with semi-urban residential street (Montréal, Québec, Canada) (Source: Raducu Dinu)*

The following chapter lists some examples of VRU case studies where some of these solutions have been implemented.

### 3.3. SOLUTIONS ORIENTED TOWARDS THE DRIVER (CATEGORY 1)

Case studies with a mix of HF related solutions and traffic calming devices/layouts such as:

- Vertical displacement (humps, speed tables and raised platforms at crosswalks);
- Road narrowing (pavement markings, islands, etc.);
- Lateral displacement (roundabouts or more rarely chicanes)

Most of these case studies refer to reconstruction and redesign of the road layout in proximity of the VRU crossings and include a combination of measures related to traffic calming and/or increased visibility to consider HF related to driver behavior.

Case Study dealing with HF and SM to protect VRU	Country	Page
Agglomeration crossing, route 148 in Montebello	Canada	210
Rehabilitation of Route 148 to Shawville and Clarendon	Canada	214
Road Safety in Rural School Areas	Chile	28
A case study of adding LED lighting facilities for crosswalk	China	34
A case study of Setting a large reduction mound on the crosswalk	China	37
A case study of the optimization of the planar cross canalization	China	41
Nicolaiplatz in Brandenburg on the Havel, Central traffic intersection as a city square	Germany	45
Railway station in Cottbus, Inner city street with tram and bus	Germany	50
Johannesstraße in Erfurt: Main road with raised surface at a tram station; Erfurt, Thuringia	Germany	56
Historic square with integrated driving areas ("Schlossplatz")	Germany	61
Frankendamm in Stralsund, mainroad to the historical city-center	Germany	66
Hauptstraße in Wehr, traffic calmed sector in a shopping area	Germany	73
Design of crosswalks for children, a synthesis of best practice	Israeli-Sweden	79
Dangerous School Crosswalk because of high traffic	Italy	87
Realization of a well-respecting 20 kmh Zone, Lignano Sabbiadoro	Italy	246
Safety intervention for the Strada Alzaia Naviglio Pavese Junction	Italy	92
Sidewalks advancement to improve pedestrian visibility	Italy	102
Speed reductions scheme in a motorway work zone crossover	Italy	253
Speed Reduction Schemes on Urban Collector Road	Italy	180
Installation of "Soft" Rising Bollard to eliminate through traffic from school route	Japan	106
Proposals for Potential Countermeasures in LMICs	Madagascar	106
Road Safety Inspection of Highway MEX-057 Queretaro-San Luis Potosi	Mexico	114
Road Safety Inspection of the Free Federal Highway Mexico-Toluca (MEX-15)	Mexico	120
Arranging a pedestrian crossing on DN 28, in Valea Lupului, Iași county	Romania	125
Re-arrangement of a pedestrian crossing on DN 28, in Bălțați, Iași county	Romania	137
Safer Way to School	Slovenia	326
Bicycle passages and bicycle crossings	Sweden	145

Table 3.1 - Case studies dealing with solutions to protect VRU

### 3.4. SOLUTIONS ORIENTED TOWARDS THE VRU (CATEGORY 2)

This category includes physical separation of VRU paths, both longitudinal and transversal (i.e. over/under pass for pedestrian/bicycles), and Speed Management (mostly chicanes for bicycle paths in close proximity of the main road crossing). In comparison to the previous category, there are no vertical displacement devices for VRUs – therefore a speed table or raised platform, used to reduce the speed of vehicles, will also be used to provide a uniform crossing passage for pedestrians or bicycles. This treatment is included under the general approach to ensure such physical characteristics of VRUs paths with low risks to pedestrian walk (e.g. lowered curbs) and bicycle ride (e.g. no curb), to reduce single accident VRUs due to surface irregularity.

<b>Case Study dealing with VRU own behaviour and/or environment</b>	<b>Country</b>	<b>Page</b>
<b>Floor Markings Combatting Motorcycle Crashes in Rural Left-Hand Curves</b>	Austria	205
<b>Kinematics of powered two-wheelers (PTW) at bends on intercity roads</b>	France	148
<b>Crosswalk removal</b>	Italy	152
<b>Road Safety Inspection of Highway MEX-057 Queretaro-San Luis Potosi</b>	Mexico	114
<b>Road Safety Inspection of the Free Federal Highway Mexico-Toluca (MEX-15)</b>	Mexico	120
<b>Building wider and dedicated cycling paths to segregate pedestrians and cyclists</b>	Singapore	155
<b>Construction of elevated pedestrian walkways or underpasses</b>	Spain	157
<b>Protected Cycling Routes</b>	Spain	162
<b>Segregated cycle paths from the main travelled way</b>	Spain	165
<b>Evaluation of sweep-salting – a method for winter maintenance of bicycle paths</b>	Sweden	171
<b>Warm wetted sand for skid control of walkways and bike paths</b>	Sweden	174

*Table 3.2 - Case studies dealing with VRU own behaviour and/or environment*

## 4. HUMAN FACTORS

PIARC defines the term “Human Factors” (HF) as “the contribution of stable psychological and physiological limits of the human nature to the development of a technical dysfunction or failure in handling machines and vehicles, for all users regardless of age, culture or race” [7].

HF is a “*terminus technicus*” used in the jargon of industrial safety engineers since around 1930. It includes all qualities that are generally found as characterizing the human limitations of perception, thinking, language and memory in operating technical facilities. Only general human qualities that are typical and stable in all people, regardless of race, culture or age etc., are included in the HF term. It excludes temporary individual reactions and conditions, such as aggressiveness, willing to violate rules or to mistakes caused by the consumption of medicines, drugs and alcohol [9].

The HF concept in relation to road safety refers to the direct and automatic interaction between the characteristics of the road and the perception of the users and analyses the contributions of the driver in the sequence of the possible driving mistakes, which can be caused by an incorrect interaction with the characteristics of the road and its surrounding environment.

According to the HF principles, since the driver’s automatic reactions cannot be changed, attention should be focused on improving the road characteristics according to driver’s psychological and physiological limits. The HF concept specifically aims at reducing the probability and consequences of human mistakes within the road system; a road design based on HF principles brings to a user-friendly or “ergonomic” road, giving substance to the well-known concept of “self-explaining roads”.

An “ergonomic” road design meets the three PIARC fundamental rules [7]:

- **Optical guidance:** the road should give users enough anticipation time at critical decision points (junctions, sharp bends, pedestrian crossings, bus stops, driveways etc.) to perceive and adapt their driving behaviour to the changes in the road course (the “4-6 seconds” rule);
- **Spatial perception:** The structure and organization of the roadside and of the surrounding landscape should lead drivers to choose the appropriate speed and to stabilize lane tracking (the “field of vision” rule);
- **Driver’s expectations:** the road should pre-program the driver’s actions correctly and respect their expectations formed by their recent perceptions (the “logic” rule).

The main safety impact of a self-explaining road consists in influencing the driver’s perception of the road and traffic situation. Indeed, approximately 90 percent of the information used by driver is obtained visually [11] [9]. The type of road section, its longitudinal and vertical alignments, the road width, the type and position of signs and road markings, the roadside design and the characteristics of the surrounding environment, provide a continuous flow of information to the driver who acts accordingly, instinctively driven by their very recent past experience on that road.

### 4.1. OPTICAL GUIDANCE

The time required by an average driver to adapt from one traffic situation to the next or to adjust to new requirements last longer than the values considered in the current guidelines.



Road design guidelines refer to a "simple stimulus-reaction time" when dealing with the evaluation of the Stopping Sight Distance (SSD). To safe break in front of a sudden obstacle a sight distance calculated considering a perception/reaction time of 1-2 seconds is usually required.

Instead, an anticipation time of 4-6 s is necessary before any critical location along the road (e.g. junctions, curves, railway crossings, bus stops, bicycle paths, entrances of villages and towns, end of a newly upgraded road section, change of road hierarchy, etc.), especially if these changing driving challenges are coming up surprisingly. To safely engage these critical challenges the users' driving program must be adjusted ("perception - decision time", Decision Sight Distance DSD). A user-friendly or "ergonomic" road gives drivers the necessary time to adapt to new and unexpected situations. In more complex situations or at higher speeds the higher values of the DSD should be considered and possibly an additional advance warning section with proper signing and instructions should be supplied like it is recommended in Dutch guidelines.

Removal of visibility restrictions, proper design of transition zones, improving the timely perception of junction locations or using of improved visibility signs and markings are some of the engineering tools allowing the optical guidance of the drivers fulfilling the HF 6 seconds rule.

<b>Case Study dealing with Optical Guidance</b>	<b>Country</b>	<b>Page</b>
<b>Road Safety in Rural School Areas</b>	Chile	28
<b>Guizhou province anshun city X462 road</b>	China	202
<b>A case study of Setting a large reduction mound on the crosswalk</b>	China	37
<b>Experimentation of a modification of the signalisation layout by Flashing directional arrows (FLR)</b>	France	176
<b>Speed Reduction Schemes on Urban Collector Road</b>	Italy	180
<b>Design of crosswalks for children, a synthesis of best practice</b>	Israeli-Sweden	79
<b>Low Cost Engineering Measures on a dangerous trunk road: Perceptual treatment</b>	Portugal	187
<b>Re-arrangement of a pedestrian crossing on DN 28, in Bălțați, Iași county</b>	Romania	195

*Table 4.1- Case studies dealing with the Optical Guidance rule*

## 4.2. SPATIAL PERCEPTION

Motorized driving changes the field of view with higher frequencies than any other movement. Monotonous or high-contrast periphery (optical flow), optical misguidance or optical illusions, deceptive or distracting impressions affect the quality of driving. The road, together with its surrounding offers an integrated field of view. The field of view can either stabilize or destabilize drivers; it can tire or stimulate them. It can also result in either increased or reduced speed. Speed, lane-keeping and reliability of direction are functions of the quality of the field of view.

Driving is a very field-dependent action. Users' behaviour is influenced by their perception of the road environment. Designing roads including the surrounding landscape management, so as to provide a good-quality users' field of view, is very helpful to improve safety.

A good-quality field of view safeguards the driver and keeps him from drifting to the edge of the lane or even leaving it. Misleading eye-catching objects in the periphery of the field of view activate subconscious changes in direction and can lead to gross mistakes in steering. At a minimum, they lead to disturbances in lane-keeping, though these can mostly be corrected.

A field of view having a reduced optical density (defined as the number of objects that contrast with the background) drives the users to subconsciously speed up, depending the operating speed on the interaction of the human information processing with the optical density of the field of view. A self-explaining road will give drivers a well-designed field of view with sufficient contrasts to increase the activation of the nervous system and thereby the alertness.

A self-explaining road design will avoid optical illusions or misleading eye-catching objects that destabilize drivers and negatively impact their driving, especially at adverse visibility conditions.

Case Study dealing with <u>Spatial Perception</u>	Country	Page
<b>Floor Markings Combatting Motorcycle Crashes in Rural Left-Hand Curves</b>	Austria	205
<b>Agglomeration crossing, route 148 in Montebello</b>	Canada	210
<b>Rehabilitation of Route 148 to Shawville and Clarendon</b>	Canada	214
<b>A case study of color wide solid center line</b>	China	217
<b>Guizhou province anshun city X462 road</b>	China	202
<b>Wrong way driving on motorway E18 Halikko ramp, Salo</b>	Finland	220
<b>Wrong way driving on motorway E18 Pappila ramp, Salo</b>	Finland	227
<b>Evaluation of audio-tactile systems to prevent run-off-roads: in situ study</b>	France	234
<b>Evaluation of audio-tactile systems to prevent run-off-roads: driving simulator study</b>	France	238
<b>Optical illusion in a tunnel</b>	Italy	242
<b>Realization of a well-respecting 20 kmh Zone, Lignano Sabbiadoro</b>	Italy	246
<b>Speed reductions scheme in a motorway work zone crossover</b>	Italy	253
<b>Sequence design of the internal space of the tone suppressing speed excess</b>	Japan	259
<b>Low cost Engineering Measures on a dangerous trunk road: Road signing and marking</b>	Portugal	259
<b>Changing the Character of Roads within Silver Zones to lower speed limits</b>	Singapore	270
<b>Introducing Traffic Calming Markings (TrCM)</b>	Singapore	276
<b>Introducing Broader Alignment Lane Markings (BALM)</b>	Singapore	278
<b>Increasing the safety depend on bad layout parameters</b>	Slovakia	280
<b>Calming measure in town Podturn</b>	Slovenia	285
<b>Credible speed limit in Zone 30</b>	Slovenia	290
<b>Correction of alignment perspectives</b>	Spain	297
<b>Sight improvements at intersections</b>	Spain	302
<b>New Road Marking in the Federal Roads</b>	United Arab Emirates	305

*Table 4.2 - Case studies dealing with the Spatial Perception rule*

### 4.3. DRIVERS' EXPECTATIONS

Drivers follow the road with an expectation and orientation logic formed by their experience and recent perceptions. Unexpected abnormalities disturb a mostly automated chain of actions and may cause drivers to "stumble". Several critical seconds pass before the disturbance can be processed. Therefore, planners should try to keep road characteristics flowing in a logical sequence. They should introduce inevitable changes as early and clearly as possible (see the 6 Seconds Rule) and exclude any sudden changes that would confuse the driver.

Users decide about the driving behaviour to adopt, judging the road category they are driving along based on road “standard” features induced by driving experience. Any deviation from the expected standard features should be gradually instructed.

The presence of vulnerable road users (pedestrian, cyclists) is not expected in high speed road categories and induces a very critical safety situation.

A bend with a reduced curvature radius has not been designed at the end of a long straight or cannot suddenly follow a curve with a too much different (higher) radius. The users do not expect to reduce their driving speed of more than 15 – 20 km/h to negotiate the following curve. Therefore, they are surprised and higher deceleration rates will be actuated due to the late recognition of the road course. Signaling the reduced curvature bend is an option but, in many instances, it is not enough. If a modification of the road layout is not possible, a very effective delineation of the bend should be considered, according to the field of view HF rule.

<b>Case Study dealing with <u>Driver Expectation</u></b>	<b>Country</b>	<b>Page</b>
<b>Road infrastructure: visual elements leading to a coherence between driver expectancies and driver behaviours</b>	France	318
<b>Human Factors Countermeasures in a fatal accident curve</b>	Germany	322
<b>Safer Way to School</b>	Slovenia	326
<b>Countermeasures in areas with risk of rear end collisions</b>	Spain	337
<b>Narrowing of lanes in areas of reduced speed (crossings, etc.)</b>	Spain	342
<b>Signing and delineation of curves</b>	Spain	346

*Table 4.3 - Case studies dealing with the Driver Expectation rule*

## 5. LOW- AND MIDDLE-INCOME COUNTRIES

### 5.1. DETERMINATION OF KEY AREAS FOR CASE STUDIES

As already noted, the starting point for this task was twofold:

- To review the information already present in the Catalogue of design safety problems and potential countermeasures [1]; and
- To consider those areas where additional information was needed to correctly apply meaningful countermeasures in a LMIC environment.

The main areas within the current catalogue were discussed and those that already had good examples for application to LMICs were acknowledged. Areas in which additional case studies would be most beneficial included:

- Workzone arrangements
- Dealing with rural corridors
- ‘Suburban’ situations where developments are progressed in isolation and no account of impact on surrounding network.
- Dealing with urban motorcycles
- Treating linear settlements
- Dealing with un-regulated public transport

### 5.2. WORK ZONE ARRANGEMENTS

The correct application and identification of work zones has been extensively covered in guidance such as PIARC: *Improvements in safe working on roads* [6]. However, the application of these measures is rarely adopted in many LMICs, despite being aware of the international requirements.



*Figure 5.1 – typical examples of inadequate work zone arrangements*

Due to a lack of specific data, there is ongoing debate and uncertainty surrounding the scale of the safety problem in relation to work zone collisions (both to the workforce and general road users). However, there is a general consensus and recognition of the higher risk exposure associated with roadside works as opposed to other occupations. Further, there is also acceptance that death and serious injury at or adjacent to work zones are a major social issue and effort is needed to reduce them as much as possible. The level of risk at each work zone will depend on the type of works to be carried out, the duration and the location – road classification and traffic volumes.

It is important to recognize that there are crucial differences between road types (rural, urban and motorway) that require varying approaches and safety provisions. Similarly, the type of work zones will influence the safety measures and approach that is most suitable, i.e. whether the works are mobile, short, medium or long term.

The type of the work zone in terms of function, area and duration can vary greatly and the environment in which the work zone is located. In turn, these variations impact on the type of risk present and the steps that can be taken to mitigate the risk. Different work zone types also present different driving conditions to other road users which have implications for safety and are a critical consideration when planning and operating the work zone. All these variations in layout requirements need to be set against a background of less than ideal road conditions, both in terms of construction standard and road user behavior in LMICs.

In the South African context, for example, good practice is applied at work zones on the national routes. Nevertheless, excessive speeds and aggressive behavior of road users at work zones remain serious risks to construction personnel. Case studies are encouraged for inclusion in future updates of this document.

### 5.3. DEALING WITH RURAL CORRIDORS

Speed is a major factor in rural road crashes. A UK study [11] of rural single-carriageway roads estimated that a 10% increase in average speed resulted in a 30% increase in fatal and serious crashes. The most common crash types on country roads are collisions at intersections, head-on collisions and running off the road– these are all effected by speed.

While rural roads can appear empty, they are often shared spaces used by vulnerable road users including pedestrians, cyclists, and horse riders, as well as slow moving farm vehicles, livestock, wild animals, and large vehicles such as buses and quarry vehicles.

Most rural roads operate at the appropriate national speed limit (either 100 or 120 km/hr). However, due to their use by vulnerable road users and the design and condition of many of these roads, 100km/hr (or anywhere near it) is rarely a safe speed to travel.

Many of these roads are narrow, with blind bends or summits (crests), and have no sidewalks / pedestrian facilities nor cycle paths. They frequently have pot holes and debris such as fallen branches and rocks, and suffer from wet and muddy conditions, meaning it takes much longer for a vehicle to stop. These factors mean that if a driver is going too fast (even if at or below the speed limit) they won't be able to react in time to people or hazards to prevent a crash. It also means that if a driver loses control, they are likely to end up in the path of an oncoming vehicle or run off the road, before they can recover.



Figure 5.2 - Typical rural corridors

Overtaking on single carriageway roads is one of the most dangerous maneuvers a driver can perform – and is usually unnecessary. Overtaking is dangerous because it is extremely difficult to accurately judge the speed and distance of approaching traffic. This lack of judgment can be fatal when travelling at high speed on the wrong side of the road. If two vehicles are headed towards each other at 100 km/hr, the gap between them decreases by about 60 meters every second.

It is therefore difficult and often dangerous to overtake on rural roads, where there will rarely be enough straight, visible road ahead to be certain that nothing is coming in the opposite direction. However, when faced with slow moving heavy goods vehicles, which are common on such roads, the temptation to overtake is great – and often occurs at inappropriate locations. Identifying appropriate overtaking locations and controlling speed to a safe level is crucial for these rural roads.

Case Study dealing with Rural Corridors	Country	Page
A case study of improving of visibility	China	350
A case study of separation of two-way traffic flow	China	355
Emergency braking ramp on roads and highways Emergency braking ramp on roads and highways	Mexico	358
Treatment of intersections in Route 9	Uruguay	361

Table 5.1 - Summary of case studies dealing with Rural Corridors

#### 5.4. SUBURBAN SITUATIONS WHERE DEVELOPMENTS ARE PROGRESSED IN ISOLATION

In many LMICs there is a rapid expansion in residential, commercial and industrial development taking place. However, this development tends to be situated in poorly defined and inappropriate sites with little or no account of the impact on the surrounding transport network.

The consequences on traffic and pedestrian patterns, and provision for transport links, are often overlooked until problems arise. The local authorities then have limited resources to rectify the situation. Whilst strong planning regulations are required to rectify this in the long term, possible measures to ameliorate the impacts on the immediate network also need to be considered. Unfortunately, there is a lack of planning, or a lack of compliance with regulations, at both macro and micro levels, creating serious challenges for roads authorities. This matter needs to be followed up in a future version of this report, as there is no case study collected to address it presently.

#### 5.5. DEALING WITH URBAN MOTORCYCLES

Motorcyclists (riders of PTWs) are 26 times more likely to die in a crash than the drivers of a passenger car [4].

In many LMICs, motorcycles are the main form of motorized transport. In some of these countries, economic progress has caused sharp increases in the number of motorcycles in circulation. PTW markets in low income countries have developed particularly rapidly. As a general rule, poorer countries have a higher PTW fleet growth rate. With more motorcycles on the road, there will certainly be an increased risk of accidents causing injury or death.

The crash statistics show that 50% of the world's road deaths occur among vulnerable road users (e.g. pedestrians, cyclists, motorcyclists) and among them, motorcyclist deaths account for 23%. In



a number of developing countries, motorcycles are the predominant vehicle type because of their affordability and ease of use particularly in urban environments. Consequently, the number of motorcyclist crashes resulting in death and serious injury in these countries is significant. Particularly in most Southeast Asian countries, motorcyclist crashes may reach about 70% of the total road crashes.

In motorcycle dominated traffic environments, motorcyclists do not usually conform to lane disciplines as passenger cars do and they tend to swerve or change their direction and speed frequently. These movement characteristics are described as non-lane-based movements and were found to be a major cause contributing to increased crash risk for motorcyclists.

To design and maintain a road network that allows for motorcyclists, practitioners need to understand and appreciate their specific needs. Some of the key factors which influence a motorcyclist's behavior include:

- A motorcycle only has two relatively small points of contact with the road surface (its tires). Changes in the road surface condition can have a big impact on grip and stability;
- As most braking and steering control is directed through the front tire, riders try to avoid skidding and losing control by not braking and steering at the same time;
- Anything that causes the tire to lose grip can lead to a loss of control much more easily than with cars;
- In curves, motorcyclists generally follow a different line to that of other motor vehicles. They use the full width of the available traffic lane in order to minimize the amount of steering input required, maximize grip and also their view of the road ahead. This may seem counter-intuitive to non-motorcyclists;
- Motorcycles are very maneuverable. They can filter through traffic and overtake in places where other vehicles cannot. They may also appear in positions where other road users do not expect them;
- Motorcycles can usually accelerate faster than other vehicles and because the rider sits higher than a car driver, they can often see over other vehicles.



*Figure 5.3 - motorcycles in a mixed urban traffic lane.*

Within urban areas dealing with large numbers of motorcycles in a confined road space is difficult. Where measures will deter vehicles they are less effective in controlling motorcycles.

## 5.6. TREATING LINEAR SETTLEMENTS

A major factor in road fatalities in LMICs is vulnerable road users on roads abutting so-called linear settlements. Here, the lack of access control and types of land use has resulted in mixed functions with residential, business, education and health facilities along the country's main arterial roads. A typical example, which is widespread in southern Africa, is residential development on one side of a rural highway, with schools on the opposite side. Overloaded heavy goods vehicles, excessive traffic speeds and a lack of facilities for VRUs compound the road safety problems. These 'coffin roads' are well-known examples of the problem with linear settlements on busy upgraded roads that occur in many LMICs.

Vulnerable road users are not the only ones at serious risk. Poorly planned turning and lay-by provision or inadequate physical restrictions on U-turns along these highways are a major cause of serious injury crashes, especially among the passengers of public transport buses. These turns are a disaster for road safety. This is a deeply embedded characteristic of the road network in LMICs and requires action across many road authorities in achieving adequate local government development planning to support safe road right-of-way management.



*Figure 5.4 - Linear settlement with no physical 'gateway' or change in cross section though village*

In many instances, the development of linear settlements along rural highways have resulted in such highways effectively becoming peri-urban arterial routes. Authorities then attempt to adopt or improve highway standards which result in a wider road environment. However, this can then have the effect that speed control can be problematic. The separation of pedestrians and through traffic is one solution for improving safety but this can be difficult to achieve.

Linear settlement roads often result in unsafe conditions, with pedestrians and vehicles entering and exiting the road from abutting property frontage. Safe System principles suggest that each property entry to a roadway should be considered as a minor intersection, with the possibility of

right-angle crashes involving vehicles entering or leaving the carriageway colliding with vehicles travelling along the road.

Case Study treating Linear Settlement	Country	Page
Setting of dimension stone pavement on highways through village	China	366
Arranging a pedestrian crossing on DN 28, in Valea Lupului, Iași county	Romania	125
Arrangement of a turning point for vehicles at DN 28 km 65 + 400, in Valea Lupului locality, Iași county	Romania	371

Table 5.2 – Summary of case studies treating Linear Settlement

## 5.7. DEALING WITH UN-REGULATED PUBLIC TRANSPORT

In some LMICs, particularly in southern Africa, un-regulated, or poor compliance, in the public transport sector has a significant impact on road safety. In South Africa for example, approximately 38% of all road fatalities are passengers in vehicles (which is a higher percentage than pedestrians). This compares to around 15% in European countries.

A specific issue is the prevalence of mini-bus taxis used for the public transport. These vehicles are used on long haul routes (between cities) as well as on daily commuter routes. The vehicles are often overloaded, can be un-roadworthy, have no seat belts for passengers, and generally operate with little regard for safety. Road crashes involving public transport, whether mini-buses or larger buses, result in a high number of casualties per incident. Examples are illustrated in the photos below.



Incident 05 March 2017 – 10 fatalities, South Africa



*Incident 05 March 2017 – 5 fatalities, South Africa*



*Incident 12 December 2016 – 7 fatalities, South Africa*

Whereas issues surrounding regulation and enforcement in the public transport sector is the responsibility of the country concerned, such issues are serious contributors to road safety challenges in LMICs. Therefore, it is worth highlighting in this Report. Case studies are encouraged for inclusion in future updates of this document.

## 6. CASE STUDIES

### 6.1. VULNERABLE ROAD USERS CASE STUDIES

#### 6.1.1. Case studies dealing with drivers-oriented solutions

##### 6.1.1.1. Road Safety in Rural School Areas

○ COUNTRY

Chile

○ IMPLEMENTATION ORGANIZATION

Public Works Ministry of Chile

○ SUBJECT

Men – Road Interaction (HF) and Setting Credible Speed Limits (SCSL).

○ PROJECT DESCRIPTION AND SUMMARY

The national highway conservation program to increase safety in the rural school environment is one of the most important road safety application policy of the Road Direction of Chile (part of the Public Works Ministry) in recent years. Since 2009, more than 600 interventions of this type have been carried out in the country.

The main objective of this initiative is to ensure calm traffic areas for schools' environments considering maximum speeds compatible with the safety of students, teachers and parents who cross the route, especially during the hours of entry and exit of students. Moreover, a special emphasis is placed on achieving operating speeds that comply with national regulations (50 km/h maximum speed in front of the school, and 30 km/h during student entry and exit times).

The implementation of safe pedestrian circuits in the area is also highlighted.

Among the more used engineering measures for traffic calming, we have:

- **Lane narrowing:** consist of painted medians or central hatching with retroreflective studs, whose width depends on the design and the type of roads where it is applied. The width of the circulation space should be between 2.75 and 3.20 meters when it is planned to leave space for only one vehicle.





*Figure 6.1 - Lane narrowing on horizontal curve with high friction surface, near to (left) and on front (right) the school.*

- **Speed humps:** Is the most coercive element to obtain a reduction in speed and increase the safety of pedestrian circulation paths, intersections, etc.
- **Speed cushion:** corresponds to a pyramidal, rectangular trunk-shaped speed hump disposed centrally in each circulation lane. Its height varies between 5.0 and 7.0 cm; the width of its base, between 1.5 and 1.7 m, and its length, between 2.0 and 2.5 m. The cushions can be installed individually, individual series, in pairs or series of pairs.



*Figure 6.2- Speed hump (5 cm height), near to (left) and on front (right) the school.*

- **Transverse lines:** They are a series of lines markings demarcated transversely - either in the whole road or in each track of the road according to the direction of traffic - with the purpose of generating in the driver the perception of going at a speed greater than the real, which induces reduce it. The distribution of the lines obeys a logarithmic spacing.





*Figure 6.3 - Transverse lines on both lanes and high friction surface, near to (left) and on front (right) the school.*

○ KEY RESULTS/ACCOMPLISHMENTS

Speed limits are posted within the school areas and the adopted countermeasures help to make them credible and therefore drivers are more inclined to follow them. However, the results depend on the engineering measure.

Considering that the main goal of these road safety projects in school zones is to enforce the current legal speed regulation (50 km/h maximum speed in front of the school, and 30 km/h during student entry and exit times), only where the speed humps were installed it was possible to reduce the speed of the motorized users less than or equal to 50 km/h in front of the school. The rest of the cases have associated speeds of operation greater than or equal to 70 km/h, and even worse, without large variations 200 meters before or after school.

ENGINEERING MEASURE	85 <sup>th</sup> PERCENTILE SPEED (km/h)					
	200 m BEFORE		ON FRONT Of SCHOOL		200 m AFTER	
	Asc	Des	Asc	Des	Asc	Des
Lane narrowing on curves	80	80	70	80	80	80
Lane narrowing on straights	85	80	75	75	80	75
Speed hump (normal height)	90	75	45	50	70	70
Speed Cushion	80	75	70	80	80	85
Transverse lines	95	100	90	100	95	110
Speed hump (low height)	80	65	40	40	60	75
PROMEDIO	86	82	70	77	81	84

Table 6.1 - SOURCE: Jaime Campos (Public Works Ministry of Chile). Evolution of speed reducers in Rural School Areas of Chile, V CISEV, Santiago, 2016.

Recently, a survey was carried out this year to 25 schools in central zone of Chile, and among the most important results was that after the interventions there were only minor run overs registers and in most of them people feel more secure to walk near the road, but it is necessary to complement this work with greater speed enforcement.

On the other hand, lane narrowing has influenced driver behaviour on the basis of the Field of View. The other solutions help the driver to understand that rural school areas are a road singularity, and it's necessary to slow down or at least be careful in driving.

#### ○ POLICIES

It has been established as an application policy for all the paving projects of the Ministry of Public Works in rural areas.

#### ○ BARRIERS/OBSTACLES

It is estimated that the main barriers overcome were the change in driver behaviour while traveling through these rural schools. Although the effect of these road safety measures decreases over time, there is already a special singularity of these areas.

#### ○ LESSONS LEARNED

Insufficient enforcement capacity to control all established speed limits on public roads.

Speed humps are the most effective traffic calming device. It must be 5.0 cm height, 4.0 m wide and the length is from shoulder to shoulder. It is estimated that in these cases two of these elements must be used, installed at a maximum distance of 150 meters.

Also, the results of this study establish that any speed reducer that is not speed hump type does not have or loses its effectiveness over time, due to the fact that the habitual user understands or possesses enough skill to travel without decelerating too much the vehicle.

Any solution adopted must have a previous road sign group that informs the user in advance of the presence of a traffic calming device. There must be regulatory, preventive and informative signals that can be complemented with road marking on the pavement.

The service life of the solutions will depend on the performance observed in the field. Therefore, the maintenance or modification of these works must be carried out according to the speed of circulation that one accept as tolerable, in a period less than 3 years (due to the maximum duration of the thermoplastic paint).

○ COSTS

U\$ 50.000 - 100.000 average cost per rural school.

U\$ 5.000.000 average budget per year for the entire country.

○ CONTACT

Jaime Campos Canessa [jaime.campos.c@mop.gov.cl](mailto:jaime.campos.c@mop.gov.cl)

○ REFERENCES

- [1] Jaime Campos (Public Works Ministry of Chile). Evolution of speed reducers in Rural School Areas of Chile, V CISEV, Santiago, 2016.

### 6.1.1.2. A case study of adding LED lighting facilities for crosswalk

#### ○ COUNTRY

China

#### ○ IMPLEMENTATION ORGANIZATION

Research of Institute of Highway Ministry of Transport of China

#### ○ SUBJECT

The case study covers the topic Vulnerable Road Users.

#### ○ PROJECT DESCRIPTION AND SUMMARY

The project is located at K56+030 on the G322 line of Zhejiang Province. This section is a level-2 highway which through the village with lots of pedestrians crossing the road, as shown in Figure 6.4. There is the Wencheng Sports Center on the north side of the road and a fitness trail on the other side of the road. The existing signs and markings are less visible at night. There is a high probability of traffic accidents between motor vehicles and pedestrians.



*Figure 6.4 - The K56+030 on the G322 line before implementation*

The project started in December 2016 and completed in June, 2017. The objective is to effectively improve the visibility of signs and markings at night, control the speed of vehicles, reduce conflict and protect pedestrians by adding LED lighting facilities for crosswalk, active light-emitting traffic signs and color anti-skid markings. As shown in Figure 6.5.

- Add 2 sets of LED lighting facilities for crosswalk to remind the traffic to pay attention to pedestrians. A set of lighting facility includes LED lights and 4 active light-emitting traffic signs that are installed on cantilevered structure. It provides lighting for both the crosswalk and the pedestrians crossing the road.
- Lay color anti-skid markings (570m<sup>2</sup>) for the warning and speed control of the vehicle in the village.



*Figure 6.5 - Setting 2 sets of LED lighting facilities and active light-emitting traffic signs*

○ KEY RESULTS/ACCOMPLISHMENTS

It has a significant effect on traffic safety. The observation point is opposite the Wencheng Sports Center. It took one hour for the observation (16:00-17:00). In the observation after the implementation, the vehicles slow down while crossing the crosswalk. There is no significant conflict between motor vehicles and pedestrians. There were 4 serious traffic accidents occurred on this section before the implementation, caused by collisions between cars and pedestrians or electric two-wheeled vehicles. No such accidents occurred within 6 months after the implementation.

○ LESSONS LEARNED

The LED active light-emitting road traffic signs are able to satisfy the long distance visibility under the unfavourable conditions such as the night, rain fog and so on by adopting a series of reflective material and technologies. The colour anti-skid marking also play a good role in warning and speed control. It can reduce the possibility of collisions between motor vehicle and pedestrian, so as to improve the safety of pedestrian crossing the road. During the implementation, we find it is an effective measure to protect pedestrian by setting up proper pedestrian barriers, as shown in Fig 3. It can effectively prevent motor vehicle from occupying sidewalk, reduce collision with pedestrians if vehicle out of control, it also helps regulate pedestrian crossing behaviour and protect pedestrian safety.





*Figure 6.6 - Setting up the pedestrian barrier*

○ COSTS

The price of the colour anti-skid marking is RMB220 yuan per square meter. It costs RMB125400 for markings (570 square meters). The price of a set of LED lighting facility is RMB40480 (the LED lights for RMB5000 and 4 active light-emitting traffic signs for RMB35480). It cost RMB80960 for 2 sets of LED lighting facilities. The total cost of the project is about RMB206360.

○ CONTACT

Dr. Chengcheng TANG E-mail : 973939419@qq.com

### 6.1.1.3. A case study of Setting a large reduction mound on the crosswalk

#### ○ COUNTRY

China

#### ○ IMPLEMENTATION ORGANIZATION

Research Institute of Highway Ministry of Transport of China

#### ○ SUBJECT

The case study covers the topic Man-Road Interaction(HF)

#### ○ PROJECT DESCRIPTION AND SUMMARY

It is a two-lane road with a speed limit 50km/h, located at the rear of a long straight slope to the village of Yongan. Vehicles enter the village with a high speed which is very dangerous to pedestrians crossing the street, as shown in Figure 6.7. There were two accidents between vehicles and pedestrians crossing the street during 2015 to 2016. In those accidents, the vehicles didn't avoid pedestrians because there were no traffic signs; while, the pedestrians didn't use crosswalks or other facilities when they crossed the street.



*Figure 6.7 - The view of the road before the implementation*

The project starts in December 2016 and completed in June 2017. The objectives of the project is to reduce the average speed of vehicles and improve the safety of pedestrians when they crossing street. The interventions include to set up a large reduction mound on the crosswalk and traffic signs and markings.

- Lay the discontinuous colored antiskid pavement (in red) along the longitudinal center line of the road and deceleration vibration markings (in yellow) along cross section of the road, as show in Figure 6.8.





*Figure 6.8 - Lay the coloured antiskid pavement and deceleration vibration markings*

- Most of the residents are resettled persons who migrated from the mountainous areas into the villages and towns, and most of them are the elderly people. Therefore, a pedestrian refuge island is set up on this road section to provide a safe waiting area for passing pedestrians, as shown in Figure 6.9.



*Figure 6.9 - Set up a pedestrian refuge island*

- Combine the sidewalk markings with the colour pavement antiskid paint to increase pedestrian safety when crossing the street, as shown in Figure 6.10. Some of the signs are interrupted by trees, as shown in Figure 6.11. Trim the trees to facilitate drivers to recognize the content of the signs.



*Figure 6.10 - The sidewalk area*



*Figure 6.11 - The hidden sign*

#### ○ KEY RESULTS/ACCOMPLISHMENT

The above measures have a significant effect on speed control and traffic safety issues. In the observation after the implementation, the average speed of each type of vehicles is less than 47km/h, lower than the speed limit. After the project completed, there is no collision of pedestrian crossing the street within one year. 1) It is an effective speed control measure by laying coloured antiskid pavement and the deceleration vibration markings on a long straight slope. 2) The pedestrian refuge island can improve the safety of pedestrian crossing the street. It provides a safe waiting area for passing pedestrians. The probability of collision between the vehicle and pedestrians is reduced. 3) It becomes an eye-catching area when the sidewalk markings are

combined with the colour pavement antiskid paint. The drivers will focus on the pedestrian crosswalk and reduce their speed in time, which can give drivers more seconds to take a safer driving strategy.

#### ○ LESSONS LEARNED

It is an effective speed control measure by laying colour antiskid pavement and the deceleration vibration markings on a long straight slope. In order to improve the safety of the pedestrian crossing the street, in this case, we should take good care of the old people. It is also necessary to regulate pedestrian crossing behaviour while focus on the control of the vehicle speed. The proper traffic signs and markings are essential. It is also a good example to set up a pedestrian refuge island and combine the sidewalk markings with the color pavement antiskid paint.

#### ○ COSTS

It spent about RMB21000 yuan for markings (375m<sup>2</sup>) and RMB60000 yuan for color pavement (400m<sup>2</sup>). The price of the single column sign is RMB1133 yuan per set. It cost about RMB4600 yuan for signs (4 sets). The Total cost of the project is about RMB 85600 yuan.

#### ○ CONTACT

Dr. Chengcheng TANG E-mail : 973939419@qq.com



#### 6.1.1.4. A case study of the optimization of the planar cross canalization

○ COUNTRY

China

○ IMPLEMENTATION ORGANIZATION

Research of Institute of Highway Ministry of Transport of China

○ SUBJECT

The case study covers the topic Vulnerable Road Users.

○ PROJECT DESCRIPTION AND SUMMARY

The implementation section is located at the intersection of S210 and S103 Hangjin lines in Zhejiang Province. Two four-lane roads cross in a small angle of 14 degree, and the range of this intersection is too wild, meanwhile, the distance of the stop line is too long. The total pavement width of the original pedestrian crossing is 37m. The elderly and children cannot cross the intersection within the green time and there is no pedestrian waiting zone for them. There is a conflict between crosswalk and lane markings for turning vehicles. Both roads have large traffic, according to traffic statistics in 2015, the average daily traffic volume of the main road is 19,295, the equivalent number is 22,605. The average daily traffic volume of the crossed road is 21,686, the equivalent number is 25,406. The degree of urbanization in the surrounding areas is high, non-motorized vehicles are densely crowded, and there are many branch roads in the two provincial roads, and the roadside interference is relatively large. Lane organization and signal setting are not reasonable. As shown in Figure 6.12.



*Figure 6.12 - The intersection of S210 and S103 Hangjin line before implementation*

The project started in December, 2016 and completed in June, 2017. The objective is to effectively improve the traffic efficiency of vehicles and protect the vulnerable road users by reducing the range of intersection, optimizing the location of crosswalk and setting a pedestrian waiting area.

- Reduce the range of intersection and shorten the distance of the stop line from 200m to 88m, as shown in Figure 6.13.



*Figure 6.13 - Shorten the distance of the stop line*

- Optimize the location of the crosswalk, balance the needs of pedestrian and tuning vehicles and add a pedestrian waiting area, as shown in Figure 6.14.



*Figure 6.14 - Add a pedestrian waiting area*

- Set up a physical transportation channelization island with a size of  $54\text{m}^2$ , set up traffic lights of door structure, add sidewalk lights, adjust the traffic light phase, and optimize the electronic police system settings, as shown in Figure 6.15.



*Figure 6.15 - Perfect the traffic lights*

- Reorganize lanes according to traffic flow and signal settings, update markings and signs and add safety facilities such as lane separation signs and pedestrian direction signs, as shown in Figure 6.16.



*Figure 6.16 - Setting lane separation signs*

#### ○ KEY RESULTS/ACCOMPLISHMENTS

It has a significant effect on improving the traffic efficiency of intersections. In the observations conducted after the implementation (the observation time is close to the evening rush hour), the traffic volume in each direction basically matches the green light timing. There is no traffic jam at the intersection. Both non-motor vehicles and pedestrians are safer.

#### ○ BARRIERS/OBSTACLES

The range of this intersection is too wild. The traffic lights were unreasonable. The crosswalk was too long for the elderly and children to cross the intersection within the green time. There is a conflict between crosswalk and lane markings for turning vehicles. There was a safety hazard in setting the crosswalk at the left turn lane of S210 and the right turn lane of S103. It is necessary to satisfy the safety of pedestrians and improve the traffic efficiency.

- LESSONS LEARNED

The purpose of setting up the traffic island is to regulate the trajectory of vehicles, fix the conflict points and remove areas that are not used in crossing areas, while, it can also provide space for facilities and have the function of a safety island. In this case, it provides the pedestrian safety and improves road access efficiency as well.

- COSTS

Along the S210, there were 3 similar intersections in which these measures were carried out, the total cost is about RMB 1.34 million. Since it's no easy to count the specific amount, the approximate costs of each intersection is RMB 0.45 million.

- CONTACTS

Dr. Chengcheng TANG E-mail : 973939419@qq.com



### ***6.1.1.5. Nicolaiplatz in Brandenburg on the Havel, Central traffic intersection as a city square***

○ COUNTRY

Germany

○ IMPLEMENTATION ORGANIZATION

Stadt Brandenburg an der Havel, Fachbereich IV, Fachgruppe 67.3

○ SUBJECT

Areal improvement of the quality of stay by bundling the motorized traffic

○ PROJECT DESCRIPTION AND SUMMARY

In this project a central square in Brandenburg an der Havel was redesigned into a three-arm junction.

Brandenburg an der Havel is a city with about 71.000 inhabitants in the region Brandenburg in north-east Germany. The Nicolaiplatz is a triangular square with an important function for the local traffic, located in the city centre, nearby the historic city of Brandenburg an der Havel.

The sums of the traffic volumes of all access roads to Nicolaiplatz are approximately:

- 15.000 vehicles
- 450 city busses
- 360 trams
- 500 cyclists (estimated) per 24 hours.



*Figure 6.17 - Nicolaiplatz before remodeling (Source: Stadt Brandenburg, ARGE NP Consult)*

Before the redesign, the function and geometry of Nicolaiplatz was significantly influenced by the traffic facilities before the remodeling (see picture 1). The Bus- and Tram stops were spread over the entire square and the whole traffic infrastructure was disordered and unclear for both, motor vehicle traffic and local public transport. Furthermore, all facilities were outdated and not in a good condition.

Essential requirements for the redesign of the square concerned:

- the bundling of the converging roads in a 3-arm junction with traffic lights,
- the reduction of the maximum speed limit to 30 km / h,
- a central arrangement of bus and tram stations and
- a significant increase in the attractiveness of the square, especially with regard to the quality of stay.

To accomplish these goals two different options were developed and rated. The criteria for this rating were:

- required spaces of the different traffic and usage areas
- transfer relations for the local public transport
- interferences between motorized individual traffic and local public transport
- potentials to revalue the square
- accessibility for delivery services to shops and businesses
- impairment of natural monuments (a plane tree and an oak on the square)
- necessary land acquisition

The chosen option fits the best to the defined goals and requirements. The capability of the traffic facilities is sufficient, and the quality of stay is recognizable.

The redesigned Nicolaiplatz (see picture 2) was taken into service in December 2013.



Figure 6.18 - Nicolaiplatz after remodeling (Source: Stadt Brandenburg, ARGE NP Consult)

#### ○ KEY RESULTS/ACCOMPLISHMENTS

After the redesign of Nicolaiplatz was taken into service, the number of accidents decreased by 56%, from 36 (2010/11) to 16 (2014/15) accidents per year (see Picture 3).

The rearranging of the northern road to a residential road, which is integrated into the square, had the biggest impact on reducing traffic accidents. Before the redesign in this section there were two accidents with injured pedestrians, eight accidents in parallel traffic and four accidents related to entering and/or exiting properties (2010/11). After the redesign there were only four accidents, and no one was injured, neither pedestrians nor passengers.

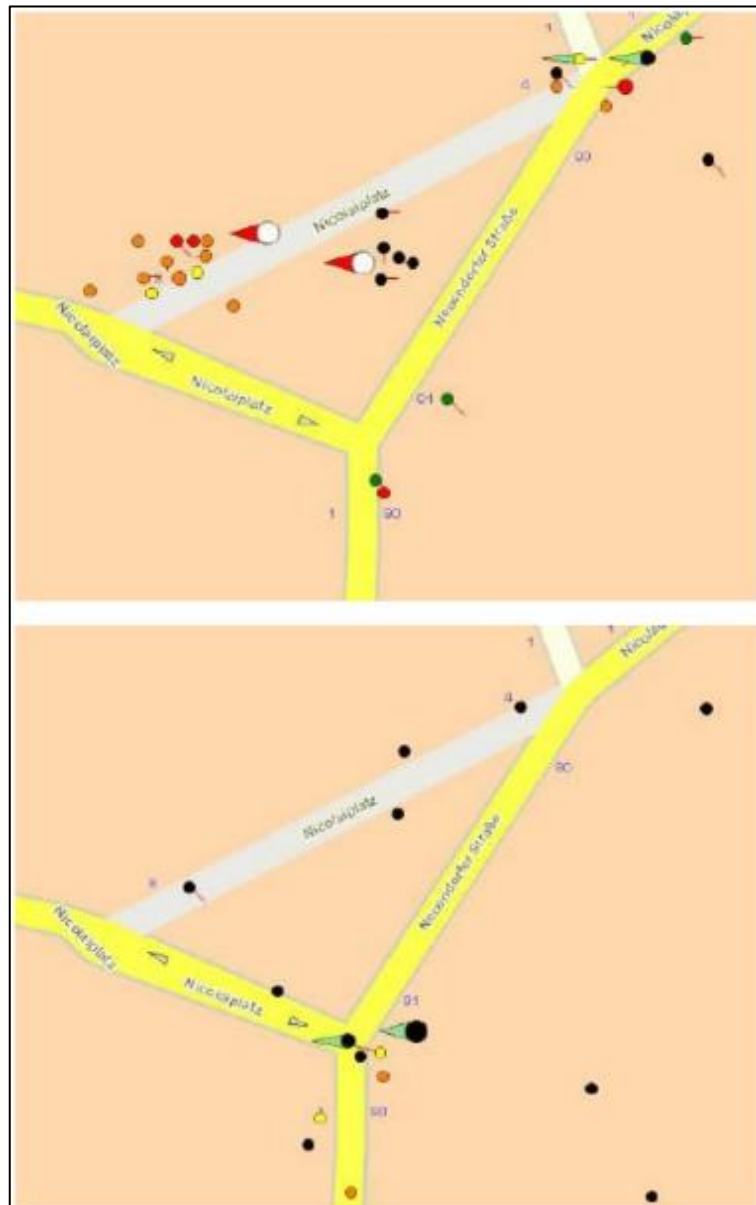

Figure 6.19 - Traffic accidents before (on the top) and after (on the bottom) redesign (Source: Stadt Brandenburg, ARGE NP Consult)

The usability of Nicolaiplatz was improved significantly by the redesign. Now it has the character of a real square. It can be recognized as a “Gate” into the historic center of Brandenburg.





Figure 6.20 - New combined tram/bus stop in the western arm of the junction (Source: [www.teamteibrant.de](http://www.teamteibrant.de))

A key accomplishment of this remodeling was the improvement of the public transport facilities. Before the redesign the tram stations and bus stops were all around the old Nicolaiplatz, so it was very complicated for passengers to change from one vehicle to another. Furthermore, there was only one signalized pedestrian crossing, which made changing even more uncomfortable and dangerous. After the remodeling, there is a combined tram and bus stop in the western arm of the junction, where passengers can change without any problems (see picture 4)

There are two further bus stops in the southern and the eastern arms of the junctions, which are less than 50 m away from the combined tram/bus stop. Also, there are now signalized crossings in every arm of the junction.

Cyclists are guided together with vehicle traffic, which is restricted to 30 km per hour in the redesigned area, but cyclists are allowed to use the side walk as well.

#### ○ BARRIERS/OBSTACLES

There are two trees on Nicolaiplatz (see picture 5), which have the status of a natural monument and needed to be retained. This was taken into account at the redesigning process, so that both trees get an exposed location on the new Nicolaiplatz.

Because of the relocation of the western arm of the junction (Magdeburger Straße) and the new facilities for public transport in this area, it was necessary to interfere with private property in the south-eastern area.



*Figure 6.21 - One of the two natural monuments (Source: Stadt Brandenburg, ARGE NP Consult)*

○ LESSONS LEARNED

As a result of the redesign of the Nicolaiplatz, it became clear that a square that was previously designed exclusively for motorized traffic could be converted into a square with a high quality of stay. Due to the reduction of the speed limit and the bundling of the motorized traffic, the number of accidents decreased enormously. In addition, the quality of the local public traffic was also clearly improved. On the other hand, in addition to the qualities mentioned above, there are also disadvantages for the motorized traffic. In peak hours there isn't a traffic flow as it was before, due to the reduction of the speed limit to 30 km/h and the bundling of the motorized traffic.

○ CONTACTS

[dschmitt@uni-wuppertal.de](mailto:dschmitt@uni-wuppertal.de) / Fachbereich VII Bau und Umwelt Fachgruppe Straßen und Brücken  
Stadt Brandenburg ([peter.reck@stadt-brandenburg.de](mailto:peter.reck@stadt-brandenburg.de))

### 6.1.1.6. Railway station in Cottbus, Inner city street with tram and bus

#### ○ COUNTRY

Germany

#### ○ IMPLEMENTATION ORGANIZATION

Stadt Cottbus, Stadtentwicklung und Bauen | Karl-Marx-Str. 67 | 03044 Cottbus, Servicebereich Technische Infrastrukturplanung, [https://www.dvr.de/publikationen/gute-strassen/bahnhofstrasse\\_cottbus/](https://www.dvr.de/publikationen/gute-strassen/bahnhofstrasse_cottbus/)

#### ○ SUBJECT

The subject of the countermeasure is to increase traffic safety, a promotion of foot- and bicycle traffic and a decrease of imissions of noise and pollution.

#### ○ PROJECT DESCRIPTION AND SUMMARY

In this project the inner city road “Bahnhofstraße” in Cottbus was redesigned to a traffic calmed road with a high quality of stay and less fine dust and noise pollution. Cottbus is a city with about 100.000 inhabitants in the region Brandenburg in north-east Germany. The street “Bahnhofstraße” is an inner city road which is in the center of the town.

Before the reorganisation the street was characterized by a high traffic number and therefore also by a high level of noise and fine dust pollution. Traffic was reduced thanks to the completion of a connecting road which has shifted traffic from downtown Cottbus and the “Bahnhofstraße” to the outside.

The redesign is concerned with a decrease of traffic-related noise and air pollution and improving traffic safety, as well as the interests of non-motorised road users. In addition to securing and promoting bicycle traffic, a significant improvement in crossability for pedestrians and accessibility in target vehicle traffic was aimed by creating longitudinal parking spaces and loading zones. By planting trees on both sides, the original avenue character was to be taken up again and thus, on the one hand, the quality of living was to be strengthened and, on the other hand, the road space was to be effectively structured.

The design concept is based on a continuous three-lane road cross section (see Figure 6.22). An important feature is a 3.25m wide central strip, which takes over several functions on the course of the street. In addition, the cross section provides for a common lane in each direction of travel for motor vehicles and trams. The maximum speed limit is 30 km/h.





Figure 6.22 - Site plan after the redesign, source: Stadt Cottbus

Public transport by bus and tram is managed together with individual motorised transport. The two stops “Stadtmuseum” and “August-Bebel-Straße” are designed in a lateral position as a bus stop cap. The tracks are flush with the road surface.

The traffic was opened in December 2012.

#### ○ KEY RESULTS/ACCOMPLISHMENTS

The three-lane road cross section allows flexible use of the 3.25m wide medial strip throughout:

- This is paved throughout the route sections in natural stone format (large pavement) and bordered with flat boards. It is used here to structure the cross-section in terms of design and as a linear element to improve the traversability of the roadway.
- At places with special crossing needs, it includes barrier-free “middle-islands” equipped with guidance systems for visually impaired people.
- At intersections and junctions, it changes its function into left-hand turn strips for motor vehicle traffic, so that all relevant driving relationships can be guaranteed (see Figure 6.23).
- It offers the possibility of being used as an escape route when vehicles are stationary or in emergency situations.





Figure 6.23 - Three-lane road cross section after the reorganisation, source: Stadt Cottbus

The width of 3.25m offers pedestrians and cyclists a high degree of safety and comfort when crossing the road (see Figure 6.24). Even prams, bicycles with trailers and freight bicycles can be accommodated comfortably on such a width without compromising safety.



Figure 6.24 - The medial strip as a crossing aid for pedestrians, source: Stadt Cottbus

The side space shows a clear separation between the individual functions. A 2.5m wide multifunctional strip connects to the roadway. It houses more than 50 longitudinal parking stands, which have significantly improved car access in the redesigned section of the street. Next to that the multifunctional strip also serves for delivery, accommodates the alley-like tree planting and the masts for street lightning, serves in the area of the public transport stops for undisturbed waiting, getting in and out and also offers space for bicycle parking facilities, benches, signage, parking ticket machines and other necessary installations. The areas for the various modes of transport are clearly structured in terms of road cross-sections (see Figure 6.25)



*Figure 6.25 - Clear structuring and identification of areas for the individual modes of transport, source: Stadt Cottbus*

In part, front gardens could be preserved or restored by the redistribution of the areas. Additional green areas can be found through the restoration and maintenance of front gardens in front of residential buildings (see Figure 6.26).



*Figure 6.26 - Example of one of the many front gardens, source: Stadt Cottbus*

Benches provide a place where elderly people in particular can take breaks on longer footpaths and thus support walking on foot.

The stops for buses and trams are combined for both means of transport. The total length of 38m is based in the special Cottbus tram vehicles (see Figure 6.27 and Figure 6.28). The stops are equipped with spacious bus shelters for weather protection, seats and dynamic passenger information displays. The transparency of the waiting shelters supports social security for waiting passengers at night. The position of the street lightning also contributes to this.

The intersection areas of the subordinate streets are designed as partial pavements (“sidewalk crossings”), so that pedestrians can cross almost barrier-free in the course of the street. The design of the ramps is integrated into the continuous multi-functional strip.





Figure 6.27 - Combined tram-bus station, source: Stadt Cottbus

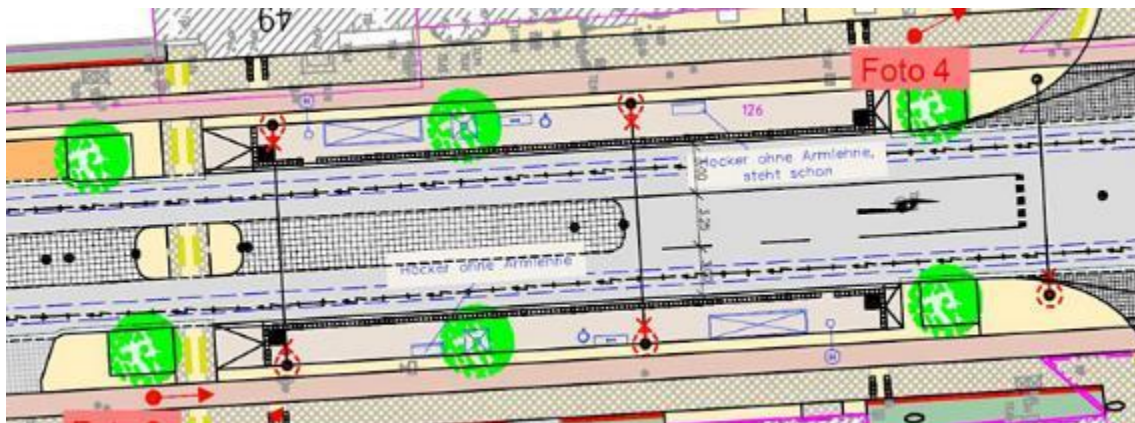

Figure 6.28 - Plan of the station after the reorganisation, source: Stadt Cottbus

#### ○ LESSONS LEARNED

In the investigation area of the street “Bahnhofstraße” between Berliner Straße and Karl-Liebknecht-Straße, the following statements can be made regarding the accident:

- the number of accidents recorded by the police fell by a total of around 24% in the year following the opening for traffic (2012/2013) compared with the period under consideration one year before the reconstruction (2010/2011).

- Most accidents occurred in longitudinal traffic along the street. In 2011/12, 21 accidents of this type were concerned. As a result of the reorganisation and the associated restructuring, longitudinal traffic accidents were significantly reduced by 4 accidents in 2012/13.

- Newly added are accidents in stationary traffic, since no parking stands were arranged along the street before the conversion. A total of 4 accidents with parked vehicles were recorded within the first year after opening for traffic. Despite the safety distance of 0.75m between the multifunctional strip and the cycle path, one cyclist was involved in one case.

All in all, the redesign has made this important inner-city street significantly more attractive and revitalised. The quality of the street design is now appropriate to the urban ambience, and the avenue makes a significant contribution to this.

The good quality of living also strengthens the use of the buildings. Housing and shop vacancies have largely disappeared.

The qualities for non-motorised traffic have been significantly improved with the redesign. On the one hand, this applies to the pedestrian crossability of the road, which is still relatively busy, especially in the sections between the junctions. On the other hand, a traffic axis previously avoided by cyclists has meanwhile developed into a heavily used cycle route.

Public transport is finding good functional conditions, not least due to the decline in car traffic after completion of the western clasp of the middle ring. The latter also applies to the motorised-individual-traffic portion remaining in the road, which previously flows undisturbed and which can now also be turned directly to the left.

An investigation of acoustic and hygienic aspects showed that the lower traffic volumes and the reduced speed limit lead to significantly better values.

○ COSTS

Cost of the Selected Countermeasure: 8,700,000 €

○ CONTACTS

Stadt Cottbus, Stadtentwicklung und Bauen | Karl-Marx-Str. 67 | 03044 Cottbus | Servicebereich Technische Infrastrukturplanung | Email: [baudezernat@cottbus.de](mailto:baudezernat@cottbus.de)

Dominik Schmitt [dschmitt@uni-wuppertal.de](mailto:dschmitt@uni-wuppertal.de)

### **6.1.1.7. Johannesstraße in Erfurt: Main road with raised surface at a tram station; Erfurt, Thuringia**

#### ○ COUNTRY

Germany

#### ○ IMPLEMENTATION ORGANIZATION

Landeshauptstadt Erfurt, Amt für Stadtentwicklung und Stadtplanung, Abteilung Verkehrsplanung, [https://www.dvr.de/publikationen/gute-strassen/johannesstrasse\\_erfurt/](https://www.dvr.de/publikationen/gute-strassen/johannesstrasse_erfurt/)

#### ○ SUBJECT

Improvement of the quality of stay, creating more space for pedestrians

#### ○ PROJECT DESCRIPTION AND SUMMARY

In this project a main road in Erfurt (“Johannesstraße”) with a tram station was redesigned in order to improve the situation for pedestrians and public transport users in this area.

The city of Erfurt is located in the German federal state of Thuringia with about 206.000 inhabitants. The road, which was redesigned, is a radial road, which connects the northern and the southern districts of Erfurt. This connection is important for all means of transport. In this case study a section of about 360 m (between Stauffenbergallee and Juri-Gagarin-Ring, see Figure 6.29) was redesigned.

The sums of the traffic volumes of Johannesstraße (in both directions) are approximately:

- 11.500 vehicles
- 400 trams (2 tram lines, a tram each 10 minutes during the day)
- 1.600 cyclists (estimated) per 24 hours.

Before the measure the design of the road was overaged (concept from the 1970s). There was no continuous cycling infrastructure in this area of the Johannesstraße. Regarding the tram station “Boyneburgufer” there was the problem, that there was no barrier free access to the tram cars. The areas for pedestrians were too narrow, especially because the pavements were used by cyclists (although this was forbidden). The surface of the car lanes was in a bad condition.

In this section of Johannesstraße, there was a big proportion of accidents, which occurred in parallel traffic. Other frequent types of accidents were turning and crossing accidents in the area of the junction Johannesstraße/Stauffenbergallee. Most of the injured persons were cyclists.

Essential goals for the redesign of the Johannesstraße were:

- Reuse of the overly dimensioned traffic areas of the junction Juri-Gagarin-Ring/Am Hügel/Johannesstraße (Huttenplatz)
- Maintaining the privileged treatment of the tram
- Barrier free design of the tram station “Boyneburgufer”, which is used by trams with low floor technology, and an improvement of the situation for waiting passengers
- Creating a continuous bicycle infrastructure
- Improving the conditions for pedestrians as well as the quality of stay along Johannesstraße.



Figure 6.29 - Section of Johannesstraße, which was subject of the measure before the redesign (blue ellipsis), source: Google Earth

To accomplish these goals different options were developed and rated. The final draft is based on the following elements:

- Widely symmetric profile of the road
- Running the tram on its own, separate track bed – at the tram stations areas with a width of 75 cm are added, to “step out” of a tram
- Raising the surface of the car lanes up to the level of the pavements in the area of the tram stations in order to create barrier free access
- Prioritizing tram signals and implementation of a dynamic “time island” (german: “dynamische Zeitinsel”, a special type of a tram station, where the tram runs in the middle of the street and the other vehicles have a red signal, when a tram arrives at the station. This allows passengers to enter or to leave the tram safely.)
- putting bicycle traffic onto bike lanes, which lead into advisory bike lanes in the area of the tram stations
- Decreasing the width of the vehicle lanes to a minimum

Figure 6.30 shows a plan of the redesigned Johannesstraße. The Figure 6.31 and Figure 6.32 show the different profiles of the Johannesstraße in the area of the tram station before and after the redesign.

The redesigned tram station “Boyneburgufer” is located in the middle of the street and has a length of about 60 m. 75 cm wide “step out” boards support the barrier free access to the low floor tram cars. The front position of the tram cars can be located by people with visual impairments by guide strips.

The passenger exchange will be handled by a “dynamic time island” – as explained above.





Figure 6.30 - Plan of the redesigned Johannesstraße, source: Stadt Erfurt, Amt für Stadtentwicklung und Stadtplanung, Abteilung Verkehrsplanung

The traffic lanes were raised in the area of the tram station onto the level of the pavement and provided with advisory bike lanes. The dimensions are variable: into town: 3,00 m plus 1,50 m, out of town: 2,75 m plus 1,25 m (see Figure 6.31 and Figure 6.32 **Erreur ! Source du renvoi introuvable.**). These dimensions do not meet the regulations for advisory bike lanes of the German rule book "RASt", but they allow wider vehicles to overtake cyclists safely.

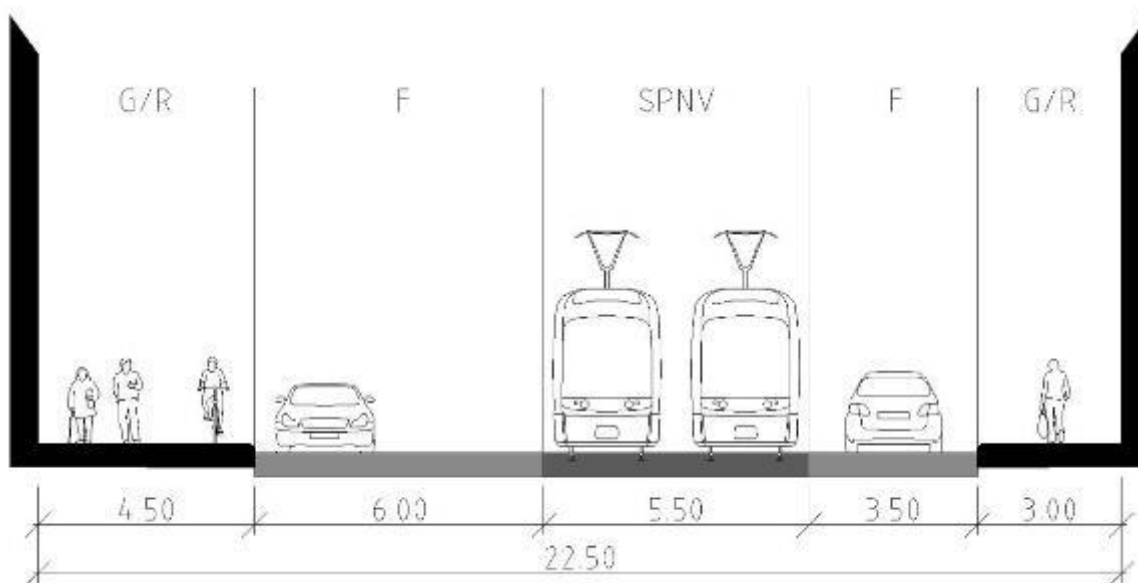

Figure 6.31 - Profile of Johannesstraße before the redesign, source: Stadt Erfurt, Amt für Stadtentwicklung und Stadtplanung, Abteilung Verkehrsplanung



Apparently, it is not possible, to preclude wrong behaviour of the users only by a good road design, especially if otherwise a detour is necessary.



Figure 6.34 - Pedestrians are crossing the tramway, source: Walter Braun, Verkehrskonzept, Aachen



Figure 6.35 - A pedestrian is using the "step out" area as a footpath, source: Walter Braun, Verkehrskonzept, Aachen

#### ○ LESSONS LEARNED

The implementation of a dynamic "time island" can be a good measure to improve the quality of stay and safety of pedestrians in narrow areas.

#### ○ CONTACTS

Dominik Schmitt [dschmitt@uni-wuppertal.de](mailto:dschmitt@uni-wuppertal.de)

Landeshauptstadt Erfurt, Amt für Stadtentwicklung und Stadtplanung, Abteilung Verkehrsplanung, Löberstraße 34, 99096 Erfurt, E-Mail: [Verkehrsplanung@Erfurt.de](mailto:Verkehrsplanung@Erfurt.de)

### 6.1.1.8. Historic square with integrated driving areas (“Schlossplatz”)

#### ○ COUNTRY

Schwetzingen, Baden-Württemberg, Germany

#### ○ IMPLEMENTATION ORGANIZATION:

Stadtverwaltung Schwetzingen, Stabsstelle Städtebau, Architektur & Verkehrsentwicklung,  
[https://www.dvr.de/publikationen/gute-strassen/schlossplatz\\_schwetzingen/](https://www.dvr.de/publikationen/gute-strassen/schlossplatz_schwetzingen/)

#### ○ SUBJECT

Areal improvement of the quality of stay by redesigning an important part of the historic centre of Schwetzingen

#### ○ PROJECT DESCRIPTION AND SUMMARY

In this project a central square (“Schlossplatz”) of 10.000 sqm was reshaped in order to improve the equal treatment of all road users in this area.

Schwetzingen is a small city with about 21.000 inhabitants in the German federal state of Baden-Württemberg. The Schlossplatz is located in the historic centre of Schwetzingen (see Figure 6.36). It lies directly by the baroque castle of the city and it builds the end of a baroque axis, which starts at the main station. It is part of a uniform ensemble and it creates a very special spatial effect. The integrated driving lanes have an access function for the historic centre for all means of transport. The castle, as well as the Schlossplatz and the baroque axis are – as an ensemble – under special protection.



Figure 6.36 - Location of the Schlossplatz in the city of Schwetzingen, source: Stadt Schwetzingen

The costs of this redesign were about 6 Mio. € and the area was reopened for traffic in January 2011.

The traffic volumes of the driving lanes of the Schlossplatz are approximately:

- 7.200 vehicles/24h



- 150 city busses/24h
- pedestrians and cyclists/12h.

The redesign of the Schlossplatz was part of a general redesign of the “baroque axis” of Schwetzingen from the main station in the east to the castle in the west. Before this measure two other areas of this axis were redesigned (Main station square in 2002, Carl-Theodor-Straße in 2004)

Regarding the traffic planning aspect this measure was part of a common traffic development plan of the cities Schwetzingen, Plankstadt and Oftersheim from the year 2003. After a urban bypass (B535) was finished in 2009 the traffic volumes in the city centre decreased so significantly, that it was possible to dismantle the street which passes the Schlossplatz (B36). However the accessibility of the public transport system – regional busses – should be retained.

Beside the redesign, the street, which passes the redesigned area, was declared as a “traffic calming area” (Verkehrsberuhigter Bereich). That means, that all vehicles may only drive with step speed.

The Schlossplatz is surrounded by restaurants and cafés, which is not only the destination for about 700.000 day trippers, which visit Schwetzingen per year, but also for the residents. This highlights the function of stay of this square. Before the reshape, the design of the square did not meet the requirements to fulfil this function properly (see Figure 6.37).



*Figure 6.37 - Before the redesign: Narrow areas for pedestrians and significant separation effect right in front of the castle, source: Stadt Schwetzingen*

The square was used for over 30 years almost only for vehicular traffic. In the year 2002 the traffic volumes were about 13.500 vehicles/24h.

Furthermore the traffic lanes had an effect as a barrier between the two parts of the Schlossplatz.

In the last three years before the redesign (2008 – 2010) two rear-end collisions were registered by the police. No pedestrians or cyclists were harmed in this time.

Central goal of the redesign was to recreate the historical unit between the castle, the baroque city and a representative square area. To reach this goal more specific sub-goals were defined:

- Increasing the quality of stay and calming the traffic on the whole square



- Decelerating the vehicular traffic
- Creating a compatibility between pedestrians, cyclists and other usage requirements
- Renovation of all street surfaces
- Creating green areas on the square
- Designing the night view of the square (see Figure 6.38)
- Building a infrastructure for bigger events



*Figure 6.38 - Schlossplatz by night after the redesign, source: Licht Raum Stadt Planung GmbH, Wuppertal*

The final design planning (see Figure 6.39 and Figure 6.40) includes the following measures and elements:

- Integration of lanes for vehicular traffic, including a bus stop
- A slight displacement of the traffic lanes in front of the castle
- Deconstruction of the light signal system
- Use of high quality materials (natural stone slabs) for pedestrian areas
- Distinction between pedestrian areas and vehicular traffic by using bollards made from granite
- Ordering a “traffic calming area” (StVO-Sign No. 325)
- Planting a two row tree avenue, consisting of 52 trees in total



Figure 6.39 - Final design planning, source: Stadt Schwetzingen



Figure 6.40 - Aerial view of Schlossplatz, on the left hand side the driving lanes for vehicular traffic, source: Tobias Schwerdt, Schwetzingen

#### ○ KEY RESULTS/ACCOMPLISHMENTS

In the first six years of the redesign of the Schlossplatz (2011 – end of 2016) only two rear-end accidents occurred, which is the same result as in the three years before the redesign. No one was injured during these accidents.

Observations after the redesigning showed, that the average speed of the vehicular traffic was 15 km/h. Furthermore, it was perceived, that car users let pass crossing pedestrians in about two of three cases. This shows how good the new “traffic calming area” was accepted by the users.

Further positive effects of this measure were observed:

- The unity of this redesigned square, the castle and the baroque city is now noticeable for everyone
- By realizing an urban bypass, the traffic volumes decreased in this area, which intensifies the positive effects on the quality of stay around the Schlossplatz
- The slow velocities of vehicular traffic have a good impact as well on the road safety as on the quality of stay
- Pedestrians have more freedom regarding their mobility and there are now better conditions for handicapped people
- The bars and restaurants around Schlossplatz have detected a significant increase of revenues after the redesign

#### ○ CONTACTS

[dschmitt@uni-wuppertal.de](mailto:dschmitt@uni-wuppertal.de) / Stadtverwaltung Schwetzingen, Stabsstelle Städtebau, Architektur & Verkehrsentwicklung, Hebelstraße 7, Postfach 1920, 68723 Schwetzingen, Email: [info@schwetzingen.de](mailto:info@schwetzingen.de)



### 6.1.1.9. Frankendamm in Stralsund, mainroad to the historical city-center

#### ○ COUNTRY

Germany

#### ○ IMPLEMENTATION ORGANIZATION

Hansestadt Stralsund, Abteilung Straßen und Stadtgrün, Badenstraße 17 | 18439 Stralsund, [https://www.dvr.de/publikationen/gute-strassen/frankendamm\\_stralsund/](https://www.dvr.de/publikationen/gute-strassen/frankendamm_stralsund/)

#### ○ SUBJECT

Create a more attractive road to the historical city center

#### ○ PROJECT DESCRIPTION AND SUMMARY

In this project the street “Frankendamm” in Stralsund was rebuilt into an attractive street in the historical centre.

Stralsund is a medium-sized town with about 58.000 inhabitants in Mecklenburg-Vorpommern in north-east Germany. “Frankendamm” is a radial main road connecting the old town to the city’s main road system and to the supra-local, classified road system via “Greifswalder Chaussee”.

The sum of the traffic volumes on workdays in 24 hours amount:

- 12.000 vehicles
- 200 busses
- 100 cyclists

Before the redevelopment, the quality of the “Frankendamm” was inadequate. The unstructured road space was characterised by a wide carriageway, poor crossing possibilities and unattractively designed ancillary facilities. In addition, poor surface quality led to unevenness and water accumulation on the road and pavements. Shops in the area of commercial use had increased significantly (see Figure 6.41 and Figure 6.42).



Figure 6.41 - Unattractive side space before the reorganisation, source: Hansestadt Stralsund



Figure 6.42 - Water accumulation before the reorganisation, source: Hansestadt Stralsund

The main objectives of the redesign of “Frankendamm” can be summarised as follows:

- - conversion of the appearance to a representative city entrance to the historical city center
- - improved conditions of use for all traffic systems
- - restoration of the formerly closed design quality of the road space by planting a continuous avenue
- - creation of an attractive green link between Frankenfriedhöfen, Wulflamufer and the historical city
- - upgrading of Frankendamm as an investment location for housing, gastronomy, retail and services
- - development of the central section between Hafenstraße and Otto-Vogel-Straße into an attractive residential area centre with a local supply function
- - combining functional improvements with appropriate design quality and choice of materials, also under the aspect of sustainability

To increase the attractiveness of the road for all road users the following solutions have been implemented:

- - multi-usable medial strip (crossing aid for pedestrians, accessibility for parking lanes and facilities)
- - variable width of the pavement in response to the demand
- - bicycle lane
- - reduced number of lanes for cars

The redesign took place in four construction phases:

1. two-strip track cross-section with continuous parking strips, cycle path on the building side next to the footpath, avenue-shaped tree plantations integrated into the parking strip (see Figure 6.43)
2. Two-strip track cross-section with continuous central reservation, cycle path between longitudinal parking strips and rows of trees, a wider footpath on the building side with multifunctionally used common areas between the tree beds, front gardens in one section (see Figure 6.44)



3. + 4. Two-lane carriageway cross-section with a cross-sectional division in the northern section analogous to section 1 and the abandonment of parking strips in favour of a wide green strip in the area of the “Neuen Frankenfriedhof” (see Figure 6.45). The traffic was opened in 2012.

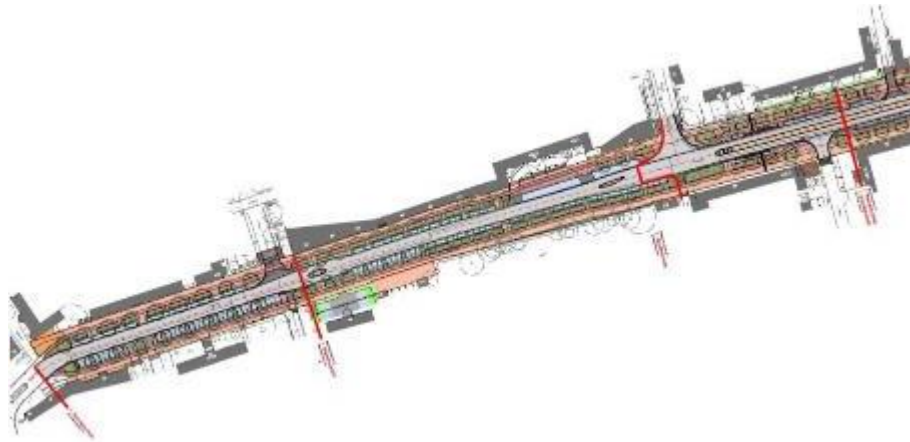

Figure 6.43 - Layout plan of the redesign section 1; source: Hansestadt Stralsund



Figure 6.44 - Layout plan of the redesign section 2; source: Hansestadt Stralsund

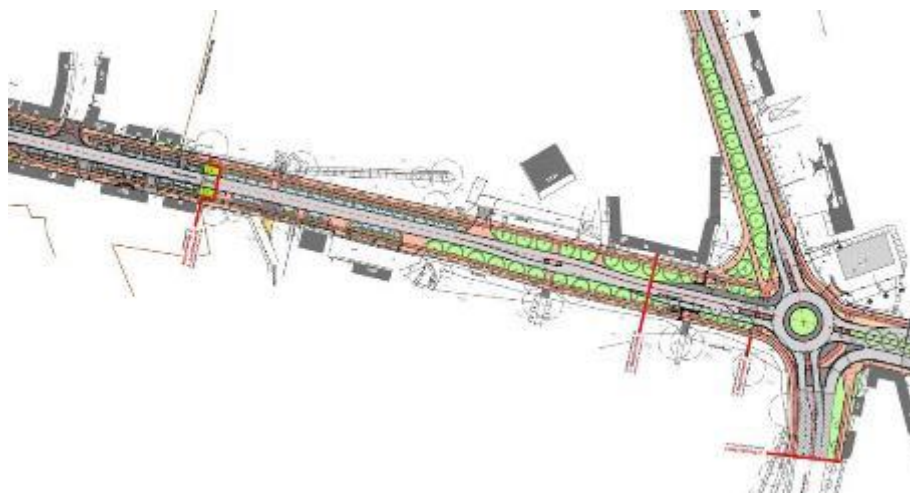

Figure 6.45 - Layout plan of the redesign section 3 and 4; source: Hansestadt Stralsund

○ KEY RESULTS/ACCOMPLISHMENTS:

In a comparison of accident data from the years before and after the rebuilding, the number of accidents involving injured persons fell by around 25%. In the years 2014 to 2016, 11% of all

accidents involved injuries (previously 22%). Most of them were slightly injured (4 out of 14) and half were cyclists. In 87% of accidents registered by the police, only minor material damage was recorded as a consequence of the accident. After consultation with the police, accidents with cyclists often result from irregular use of the cycle paths in the opposite direction. Injured pedestrians were not registered after the rebuilding.

The number of accidents at the junction Frankendamm/Werftstraße/Karl-Marx-Straße, which was an accident accumulation point before the conversion to a roundabout and has remained inconspicuous since then, has fallen significantly.

The redevelopment has led to a significant improvement in the quality of the entire road section, but especially in the central supply area. At the same time, the flexibly usable road cross section makes it easier to cross and has improved the flow of traffic.

Important design elements:

- cycle traffic routing: cycle traffic is guided continuously along cycle paths in the side space (see Figure 6.46) offers a high level of driving comfort. The cross section of the cycle path changes position in the area of junctions, either towards the guide close to the road ahead of a junction or away from the road and towards the guide close to the pavement behind a junction. Crossing the junctions close to the road increases the visibility and thus the road safety of cyclists in front of vehicles turning off.



*Figure 6.46 - Cycle path after the reorganisation, source: Hansestadt Stralsund*

- design in the central supply area: to increase the quality of the lounge and make the side space more attractive, benches, wastebaskets, bicycle racks, art objects and play stations are housed at regular intervals on multifunctional areas between the tree beds (see Figure 6.47).



*Figure 6.47 - Design in the central supply area after the reorganisation, source: Hansesund Stralsund*

- medial strip and center island: in the central supply area a three-lane road cross section was deliberately chosen, which in its central position as a paved central reservation facilitates the crossing of the roadway, makes it possible to turn left in access roads to the property and downstream junctions without obstructing the following traffic (see Figure 6.48). In the other sections at bus stops, junctions and other relevant points with crossing requirements, such as at the sports field, central islands are to increase the safety of pedestrians at certain points.



*Figure 6.48 - Medial strip after the reorganisation, source: Hansesund Stralsund*



- Junction areas and property access roads: a clear design was chosen for the benefit of pedestrians and cyclists in property access roads and subordinated road junctions (see Figure 6.49).



*Figure 6.49 - Junction areas after the reorganisation, source: Hansestadt Stralsund*

- Bus stops: All bus stops are barrier-free and equipped with weather protection. Usually the stops are in the form of a bus stop cap, at one point bus stop bay was built to prevent longer traffic holdups at that point (see Figure 6.50).



*Figure 6.50 - Bus stations after the reorganisation, source: Hansestadt Stralsund*

- Design details: the lighting of the road space is implemented with different illuminated point positions and heights on the road and side space (see Figure 6.51). In order to meet the

requirements for barrier-free use as far as possible, the cross slope of 2.5% was not exceeded. The roadway is mainly constructed with a roof profile.

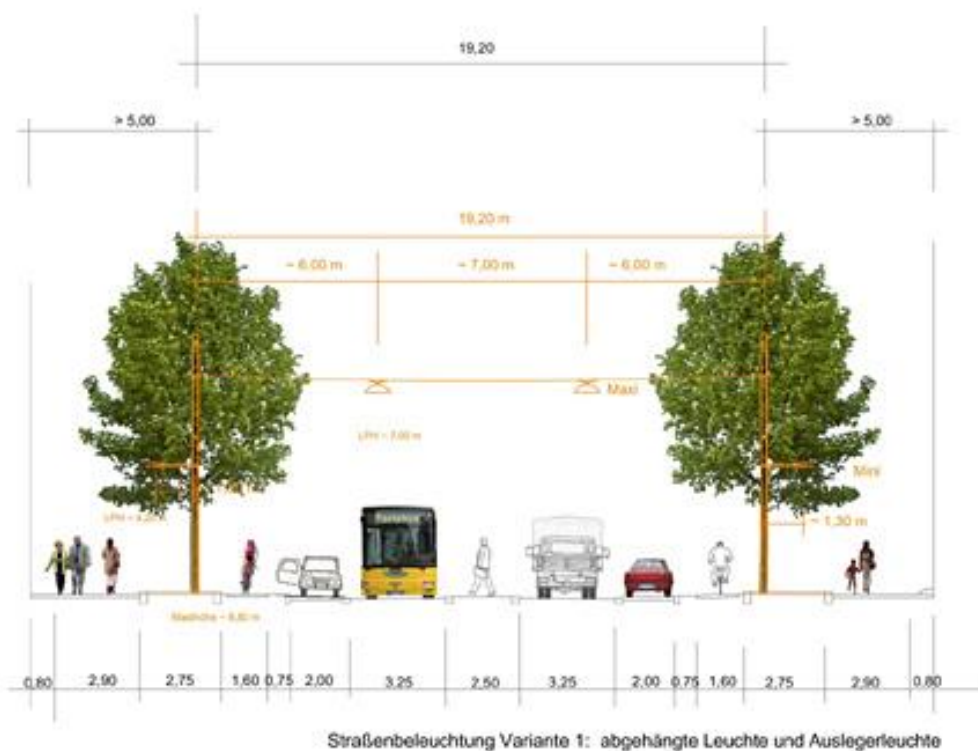

Figure 6.51 - Street lightning alternative 1, source: Hansestadt Stralsund

#### ○ POLICIES

Coordination with the public took place in the form of discussion and information events accompanying the planning. An accompanying exhibition (see Figure 6.52) also provided clear information on the history, background, basic contents and interesting planning details.



Figure 6.52 - Exhibition accompanying the planning, source: Hansestadt Stralsund

#### ○ LESSONS LEARNED

The redevelopment has led to a significant improvement in the quality of the entire road section, but especially in the central supply area. At the same time, the flexibly usable road cross section



makes it easier to cross and has improved the flow of traffic. The chosen cycle path on remote cycle paths is not an optimal solution with regard to cyclists turning to the left and turning in. Crossing the road is often associated with waiting times, which impair the flow of traffic and thus ride comfort in cycling on the cycle paths in the opposite direction to the prescribed one. The many-sided footpath relationships, in the course of road crossings or on paths between parking stand and retail shop in the central supply area, partly lead to the generously dimensioned and only low-framed tree beds being overrun in an undesirable way.

○ COSTS

Cost of the selected countermeasure: 7.700.000€

○ CONTACT

[dschmitt@uni-wuppertal.de](mailto:dschmitt@uni-wuppertal.de);

Hansestadt Stralsund, Abteilung Straßen und Stadtgrün | Badenstraße 17 | 18439 Stralsund | [strassen-stadtgruen@stralsund.de](mailto:strassen-stadtgruen@stralsund.de)

### **6.1.1.10. Hauptstraße in Wehr, traffic calmed sector in a shopping area**

○ COUNTRY

Germany

○ IMPLEMENTATION ORGANIZATION

Stadt Wehr – Stadtbauamt, [https://www.dvr.de/publikationen/gute-strassen/hauptstrasse\\_wehr/](https://www.dvr.de/publikationen/gute-strassen/hauptstrasse_wehr/)

○ SUBJECT

Traffic-calmed reshaping of the main street with improved terms of cyclists, pedestrians and superior quality of stay

○ PROJECT DESCRIPTION AND SUMMARY

In this project the main street is transfigured to a traffic-calmed sector with the additional design of a bypass road.

Wehr is a small city with about 12.600 inhabitants in Baden-Württemberg in south-west Germany.

The main street is the most travelled road in the town, but in the view of the new bypass road, which is built to lead the traffic around the centre.

The sums of the traffic volumes of the city on workdays per 24 hours are approximately:

- - about 5.500 to 6.000 vehicles
- - 400 cyclists
- - 5 city busses

The main street of operations is in the centre of Wehr in north-south-direction. The section which is transformed is coined by closed buildings and is characterized by the asymmetry of the road space.

The problem situation before the bypass was built (see Figure 6.53 and Figure 6.54 **Erreur ! Source du renvoi introuvable.**):

- - traffic loads of 1.000 to 1.200 vehicles at peak hour with a

- - 87% through-going traffic
- - huge noise- und exhaust-gas- pollution
- - large vehicle-areas in contrast to small sidewalks
- - bad conditions for pedestrians and cyclists without habitations or design elements

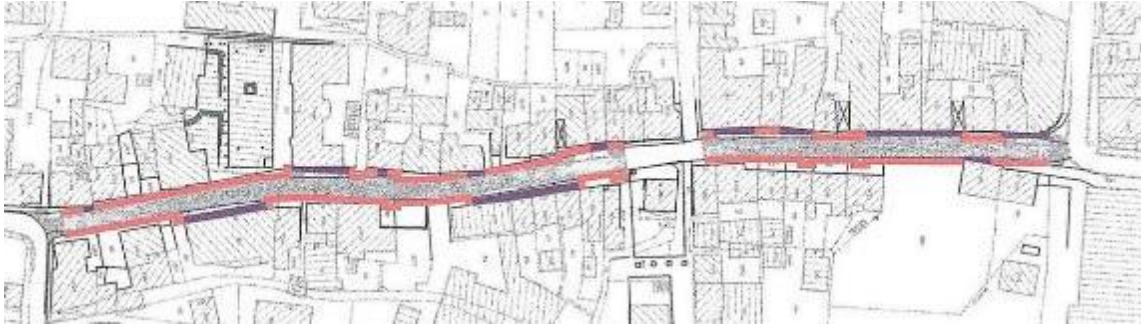

*Figure 6.53 - Before situation: narrow pavement widths (source: BSV Büro für Stadt- und Verkehrsplanung Dr.-Ing. Reinhold Baier GmbH, Aachen)*



*Figure 6.54 - Before situation: unattractiveness for pedestrians and cyclists (source: BSV Büro für Stadt- und Verkehrsplanung Dr.-Ing. Reinhold Baier GmbH, Aachen)*

The aim of the planning was a traffic-calmed redesign of the main road with the following aspects:

- Functional and creative attractiveness and profiling of the main street as a central business area of Wehr, also with integration of the adjacent squares
- Improvement of conditions for pedestrians, cyclists, resident and neighbouring uses
- Support of the relief effect of the B 518n, in particular to further reduce through traffic on the main road

In order to implement the objectives, the following points should be changed with the new design concept:

- Speed limit of 20 km/h and limited “no stopping zone”
- A 6 m wide roadway and at least 3 m wide footpaths
- An attractive side space design with water features that refer to the history of the city, with special emphasis on the area around the “Storchehus”
- Extensive renunciation of public parking spaces in the road space and changes in traffic routing at the entrance junctions

The redesign of the centre of Wehr was implemented on 2003 (see Figure 6.55)



Figure 6.55 - The redesigned main street on the floor plan (source: BSV Büro für Stadt- und Verkehrsplanung Dr.-Ing. Reinhold Baier GmbH, Aachen)

○ KEY RESULTS/ACCOMPLISHMENTS:

Between 2014 and 2016, only a single accident involving personal injury was registered by the police when a driver collides with a bollard where the road narrowed in the redesigned section of the main street.

The only defect is that short-term parking operations on the road space continue to take place in isolated cases even outside the marked areas. However, the quality achieved by the ambitious reorganisation in connection with the chosen traffic law regulation of a traffic-calmed business area does not seem to be significantly affected by this.

At the entrances, the traffic routing was changed to a deviating right of way in order to assign a subordinate function to the main road in the urban road network. Pavement at roadway level that emphasise the course of the bend of the right of way and transversal pavement strips in the side area should additionally support their effect (see Figure 6.56).



*Figure 6.56 - Design of the entrance areas (source: BSV Büro für Stadt- und Verkehrsplanung Dr.-Ing. Reinhold Baier GmbH, Aachen)*

The carriageway consists of a 5.00m wide asphalt road surface and four-line gutters 0.5m wide on both sides. The bright, 0.3m wide granite curb has been lowered to 3cm throughout. It is clearly visible as a boundary between the roadway and side spaces – also in the sense of a perceptible contrast for visually impaired people- and at the same time offers extensive accessibility when crossing the roadway.

Parking is limited throughout the entire section to 13 longitudinal parking levels, which are operated with parking discs on weekdays from 6 a.m. to 6 p.m. with a maximum parking period of 30 minutes. Delivery and loading processes take place on the road (see Figure 6.57).



*Figure 6.57 - Delivery traffic on the main road (source: BSV Büro für Stadt- und Verkehrsplanung Dr.-Ing. Reinhold Baier GmbH, Aachen)*



As part of a road surface rehabilitation in the main street in 2016, the crossing point was therefore narrowed down to increase safety, especially for school kids and the elderly, and to further reduce the speed level in the area of the “Talschulplatz”.

Cyclists are guided on the road on mixed traffic. Due to the low speed level in flowing traffic adapted to the 20 km/h zone, this was consistently accepted by cyclists even after a short adaptation period.

In the area of the crossing of two side streets and the directly adjacent forecourt of the “Storchehus”, the oldest building in the main street, the roadway was paved at the same level as the side spaces. The paving material is adapted to the side space. A kind of short “shared space” is created to emphasise the special urban development situation and make visible the need to cross and habitate/stay here.

The three water features in the side space refer historically to the element water, which has a high identity value for the city. They also invite children in particular to play during the warm season (see Figure 6.58).



*Figure 6.58 - Water elements in the side spaces (source: BSV Büro für Stadt- und Verkehrsplanung Dr.-Ing. Reinhold Baier GmbH, Aachen)*

#### ○ POLICIES

In Wehr, objects have been chosen as design elements which are of great importance for the city and its inhabitants. They contribute to the overall urbanistic picture and become an attraction for residents and tourists.

#### ○ LESSONS LEARNED

The design elements, in particular the water features, have given its very own profile to the main street in the centre, which has contributed to the high acceptance and attractiveness of the chosen solution among the population and tourists alike.

By narrowing the lanes, reducing the speed limit and building the ring road, it makes more sense and saves more time to bypass the centre. This calmed the traffic and made the centre more attractive for pedestrians.



In 2011, the number of parking stands was expanded from nine to 22 through ongoing discussion in the public short-term parking offer on the street. After an evaluation of the demand for parking space, the number of parking was reduced again to 13, as these cover the demand from experience and the impairment of traffic flow.

The share of heavy traffic in relation to the 24-hour value of vehicle traffic volume is around one percent.

○ COSTS

Cost of the Selected Countermeasure: 1.250.000€

○ CONTACTS

Stadt Wehr | Stadtbauamt | Hauptstraße 16 | 79664 Wehr | Email: [stadt@wehr.de](mailto:stadt@wehr.de)

Dominik Schmitt [dschmitt@uni-wuppertal.de](mailto:dschmitt@uni-wuppertal.de)

#### **6.1.1.11. Design of crosswalks for children, a synthesis of best practice**

○ COUNTRY

Israel, Sweden, Finland, Japan and US

○ IMPLEMENTATION ORGANIZATION

Road administration

○ SUBJECT

Crosswalk, pedestrian, children, speed, speed reducing devices, yield and stop lines

○ PROJECT DESCRIPTION AND SUMMARY

A synthesis of best practice was done to come up with a “best design” of crosswalks used by children focusing on physical measures like speed humps, speed cushions, speed tables (also called raised pedestrian crosswalks) and road markings. The analysis is based on studies from three sites in Sweden and three in Israel, research results concerning “ideal” interactions (Várhelyi, 1996), and a review of additional countermeasures as described in the literature. The Israeli case studies are summarized next.

In the Israeli case studies raised pedestrian crossings were installed at non-signalized mid-block crosswalks situated on urban arterial and collector roads, with high traffic volumes. A raised crossing is built by installing a trapezoidal speed hump on the crosswalk (1), constructing speed humps before the crossing (2) and adding traffic signs (3) - see Figure 6.59 below. At three sites included in the paper, there were high shares of child pedestrians, below the age of 18.

Actually, two countermeasure settings were applied:

(1) a bolder 15 cm high trapezoidal speed hump at the crosswalk area, combined with 8-10 cm high circular humps before the crosswalk – at two sites, and

(2) a smoother 10-12 cm high trapezoidal hump at the crosswalk area, combined with preceding circular humps that are 6-8 cm high – at one site.

The bolder design led to a substantial reduction in speeds, achieving mean speeds below 30 km/h and 85-percentile speeds below 40 km/h. The smoother design was associated with mean travel speeds of over 30 km/h and 85-percentile speeds of about 40 km/h or higher. Additional positive changes concerned a remarkable increase in the share of vehicles yielding to pedestrians in the crosswalk zone and an increase in the share of pedestrians who performed a full crossing in the designated zone. The treatment was associated with an increase in the share of pedestrians checking the traffic before the crossing but also with a decrease in the share of those who stopped before the crossing. The latter may reflect a better feeling of safety imparted to pedestrians by the raised crosswalks.



Figure 6.59 - Main components of a raised crossing arrangement, on the example of Site B in Israeli study.

Notes: 1 – a trapezoidal speed hump in the crosswalk area; 2 – a circular speed hump before the crosswalk; 3 – traffic signs and overhead amber flashing lights.

#### ○ KEY RESULTS/ACCOMPLISHMENTS

Our presumption is that actual vehicle speeds should be below 20 km/h where children (aged 7 to 12 years) are crossing a street, especially if they are walking unaccompanied by an adult. The results of field studies show that a “best design” to reach this should include a speed-reducing device located before the crosswalk. The optimal distance from such a device to the crosswalk is about 10 m if the speed limit is 30 km/h or lower. For streets with 50 km/h speed limits, a longer distance of 15 to 20 m is needed and, as a complimentary measure, the crosswalk itself should also be elevated. However, in this case (the bolder design with a 15 cm high trapezoidal speed hump at the crosswalk area, combined with 8-10 cm high circular humps) mean speeds are below 30 km/h and 85-percentile speeds below 40 km/h.

At approaches with two lanes or more, multiple-threat conflicts occur due to vehicles overtaking stopped ones in the adjacent lane. These conflicts are a threat especially to children, as they often are hidden behind the stopped vehicle if it has stopped too close to the crosswalk. To provide a stronger message for alerting drivers to stop and to stop early, and not to overtake a stopped car in an adjacent lane, *advanced yield bars or stop lines* are needed. For those, a distance to the crosswalk of about 10 m is recommended. However, installing yield lines is not yet an option available in many countries. For example, according to Finnish and Israeli regulations, yield or stop lines cannot be installed except for at signalized crosswalks, though it is already used at unsignalized crosswalks in, for example, Spain, the United States and Japan – see examples in Figures Figure 6.60Figure 6.61Figure 6.62 and Figure 6.63.



*Figure 6.60 - Speed-reducing devices and stop lines or yield bars 8 to 10 m before the crosswalk Playa de las Americas Arquitecto Gomez Cuesto, Tenerife.*

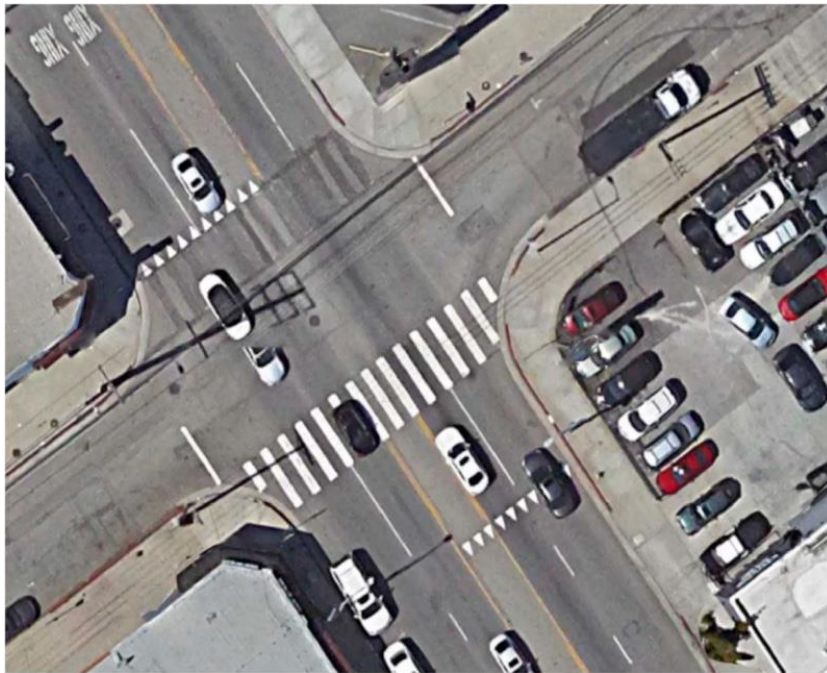

*Figure 6.61 - 'Early' yield lines at intersection, Los Angeles, USA.*



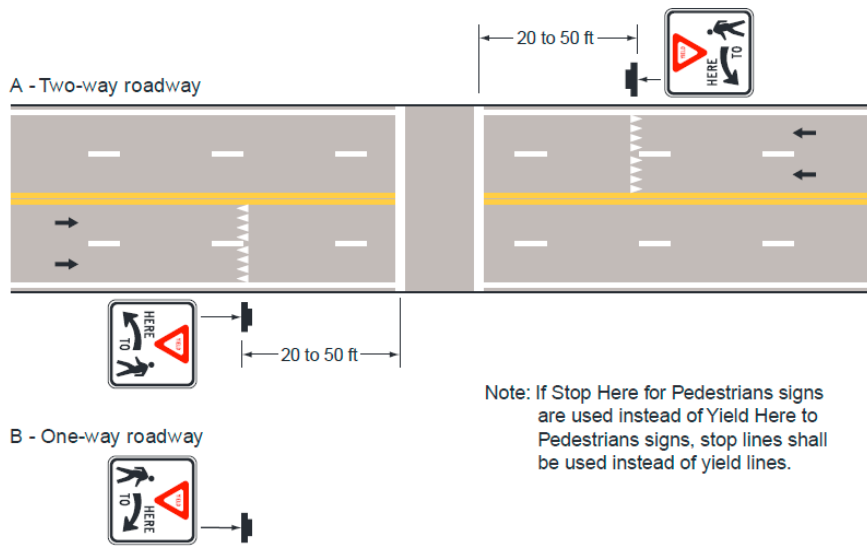

Figure 6.62 - Location of yield lines at unsignaled midblock crossing according to MUTCD (2009).







Figure 6.63 - Stop lines 5 to 10 m before an unsignalized crosswalk in Kawaguchiko, Japan.

#### ○ POLICIES

The results of field studies show that a “best design” to locate speed-reducing devices before a crosswalk depends of the speed limit. The optimal distance to the crosswalk is about 10 m if the speed limit is 30 km/h or lower. For streets with 50 km/h speed limits, a longer distance of 15 to 20 m is needed and, as a complimentary measure, the crosswalk itself are recommended to be elevated. A design with a 15 cm high trapezoidal speed hump at the crosswalk area, combined with 8-10 cm high circular humps are recommended to achieve mean speeds are below 30 km/h and 85-percentile speeds below 40 km/h.

At approaches with two lanes or more, multiple-threat conflicts occur due to vehicles overtaking stopped ones in the adjacent lane. These conflicts are a threat especially to children, as they often are hidden behind the stopped vehicle if it has stopped too close to the crosswalk. To provide a stronger message for alerting drivers to stop and to stop early, and not to overtake a stopped car in an adjacent lane, *advanced yield bars or stop lines* are needed. For those, a distance to the crosswalk of about 10 m is recommended. However, installing yield lines at unsignalized crosswalks is not yet an option available in many countries. For example, according to Finnish and Israeli regulations, yield or stop lines cannot be installed except for at signalized crosswalks, though *the policy with advanced stop lines is already used in, for example, Spain and Japan, and advanced yield lines in the United States* – see examples in Figure 6.60, Figure 6.61, Figure 6.62 and Figure 6.63.

### ○ BARRIERS/OBSTACLES

It can be noted that ironically at first speed reducing devices were seen as inappropriate on streets with bus traffic. Nowadays, they are more accepted among traffic engineers and planners. But, there is still an attempt to avoid bus cushions and other traffic-calming measures on arterials. As of now, most cities does not have a comprehensive policy with respect to these kind of solutions. This barrier is overcome in Israel. Speed reducing devices were implemented on multi-lane arterials with dual-carriageway layout and high traffic volumes and high pedestrian activity in the crossing areas were included were included in the Israeli study and proved to be very efficient.

### ○ LESSONS LEARNED

Our presumption is that actual vehicle speeds should be below 20 km/h where children (aged 7 to 12 years) are crossing a street, especially if they are walking unaccompanied by an adult. The speed-reducing device located about 10 m before the crosswalk used in the Swedish case studies was successful also in this respect. *We recommend speed-reducing devices to be located about 10 m before the crosswalk if the speed limit is 30 km/h or lower, and at a longer distance of 15 to 20 m if the speed limit is 50 km/h.* To secure travel speeds below 20 km/h, additional measures like camera enforcement of speeds near the crosswalk might be needed.

At approaches with two lanes or more, multiple-threat conflicts occur due to vehicles overtaking stopped ones in the adjacent lane. These conflicts are a threat especially to children, as they often are hidden behind the stopped vehicle if it has stopped too close to the crosswalk. To provide a stronger message for alerting drivers to stop and to stop early, and not to overtake a stopped car in an adjacent lane, advanced yield bars or stop lines are needed also at unsignalised crosswalks. For those, a distance to the crosswalk of about 10 m is recommended. The concept is already used in, for example, Spain, Japan and the United States – see examples in Figure 6.60, Figure 6.61, Figure 6.62 and Figure 6.63. *We recommend advanced yield bars or stop lines to be used also at unsignalised crosswalks*

For all types of speed-reducing devices, the long-term effectiveness will vary not only with the design but also with factors such as the strength of the material, and how well the devices are constructed and maintained. See for example Rosander, Lyckman & Johansson (2007). Especially the transition point between a prefabricated part of a speed cushion and the asphalt has to be designed to be smooth to avoid shocks that deteriorate the speed-reducing device. Figure 6.64 shows cracks on one of the two speed cushions at the test site at Tessins väg and Figure 6.65 shows how to avoid that through the “Norwegian solution” as described in an e-mail from Salerno, 2018.



Figure 6.64 - Cracks on one of the two speed cushions at Tessins väg (photo by Rolf Lysenius, February 2018).

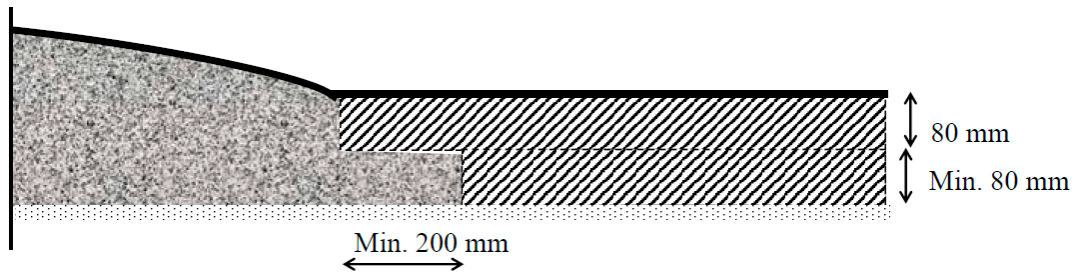

Figure 6.65 - Transition between prefabricated speed cushion and asphalt surface

In Finland, the proposed design is slightly smoother than the one used at the Swedish test sites. The height is 7 cm and the length is 3.4 m, giving a total length in the driving direction, excluding the flat part of the prefab construction, of 4.1 m. The up and down grades are 1:10, as shown in Figure 6.66 and Figure 6.67, just like at our test sites in Malmö. *We recommend Finnish speed cushion design to be used not the one used at the Swedish test sites.*

Apart from using good design to get acceptable performance, it is important to inform drivers, especially bus drivers and other commercial drivers, about the aim of the intervention. Else, they may not drive in a safe and comfortable way.

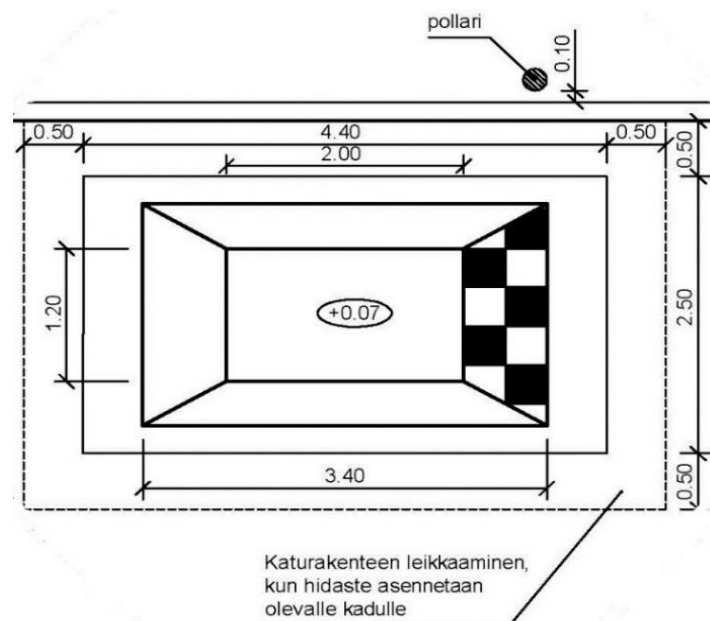
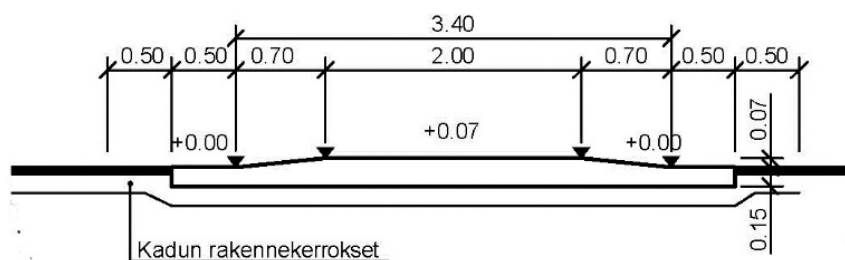

Figure 6.66 - Finnish speed cushion design detail. Note: The outer area is also cut when installing the speed cushion (mail from Salermo, City of Helsinki, 2018).



*Figure 6.67 - Profile (in driving direction) of Finnish recommendation. Note: Street structure layers in the outer cut area (mail from Salerno, City of Helsinki 2018).*

○ COSTS

The installation cost of two bus cushions and central refuge island at an existing crosswalk lacking that island, is 20,000 to 60,000 Euros. The bus cushions (including installation) are just over Euro 5,000 each. (mail from Salerno, City of Helsinki 2018).

In the Israeli studies the installation costs varied between 12,000-13,000 Euro

○ CONTAC

[Lars.Leden@ltu.se](mailto:Lars.Leden@ltu.se) or [info@larsleden.com](mailto:info@larsleden.com)

○ REFERENCES

- [1] Leden, L., Johansson, C., Rosander, P., Gitelman, V. & Gårder, P. (2018). Design of crosswalks for children A synthesis of best practice ToTS Volume 9, Issue 1:pg20-33)

### 6.1.1.12. *Dangerous School Crosswalk because of high traffic*

#### ○ COUNTRY

Italy

#### ○ IMPLEMENTATION ORGANIZATION

Florence Municipality

#### ○ SUBJECT

Vulnerable Road Users are, accordingly to their definition, the more vulnerable users of the road. Accidents that involve VRU will generally lead to bad consequences. Many countermeasures have been implemented across the road history to try to increase VRU safety with very good results. However, a lot of work has yet to be done. This example, containing a set of interventions, wants to highlight some simple low-cost countermeasures, which can be easily implemented and have a strong positive impact on the safety of vulnerable road users, especially pedestrians. This makes them particularly useful in small modifications of existing roads or an example to be taken into consideration in a new road project. The interventions focus on the concepts on Human Factors.

#### ○ PROJECT DESCRIPTION AND SUMMARY

Florence jurisdiction contains lots of different types of road, some of them are an evolution of the old roads that go through the city, some others are roads of the last years of the past century that don't take into account some safety issues. The objective of Florence Municipality (Comune di Firenze) was to implement VRU safety as much as possible with low cost countermeasures, especially within those above-mentioned roads that, due to their conformation, have some lack in road safety. The project considered pedestrian crosswalks with a high usage by children. The main countermeasures implemented by the project is represented by the construction of a pedestrian refuge island in the center of the crosswalks. This allows pedestrians to cross the road in two times, giving safer conditions especially to children, old people and disable people. Furthermore, all sidewalks close to the crosswalks were adjusted to allow the accessibility to people with disabilities. Where it has been possible, sidewalks advancements have been constructed and the parking lots have been deleted and reorganized, so as to prevent a parked car from preventing pedestrians from being visible to drivers.

Considering the implemented interventions, two of them have additional peculiarities:

- one required a change in the position of the crosswalks to place it where a refuge island could be more easily implemented and where vehicle speeds were lower (Figure 6.69 and Figure 6.70).
- one has requested the modification of the trajectory of a lane to insert the refuge island: this deflection has the double effect of a measure of "traffic calming", as it leads to a reduction in the speed of vehicles along that lane (Figure 6.71).



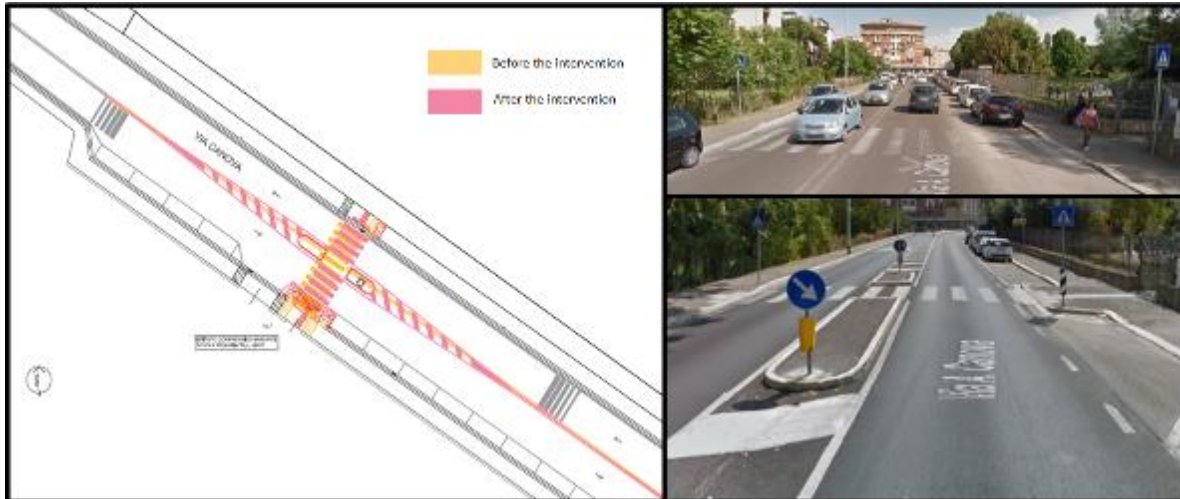

Figure 6.68 - Intervention on site 1 [4] [5]



Figure 6.69 - Intervention on site 2, moving of the crosswalk position close to the roundabout intersection [4] [5]

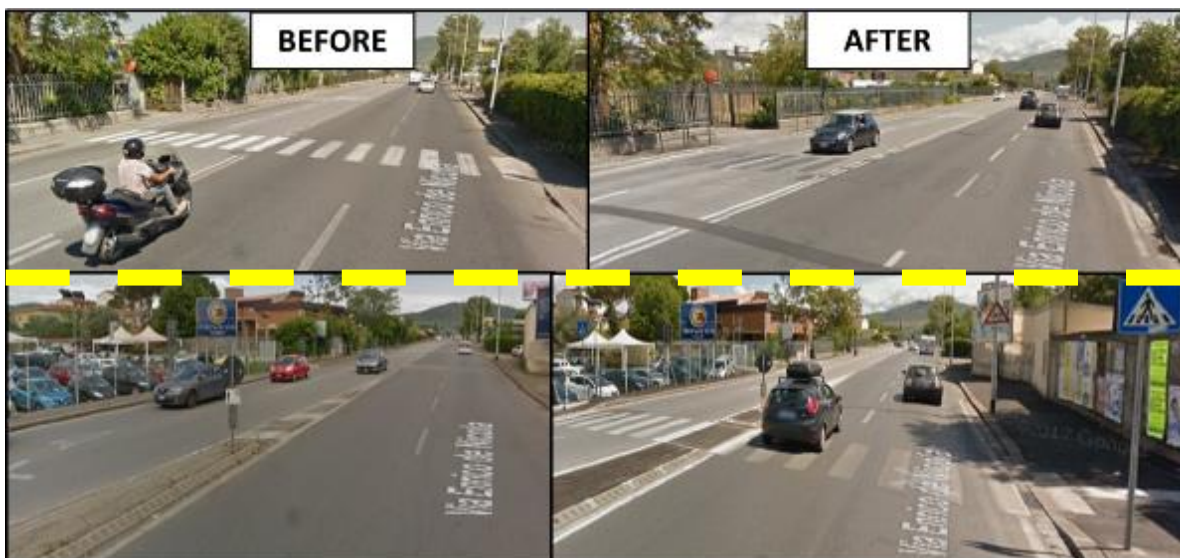

Figure 6.70 - Intervention on site 2, crosswalks before the intervention and after the intervention [5]

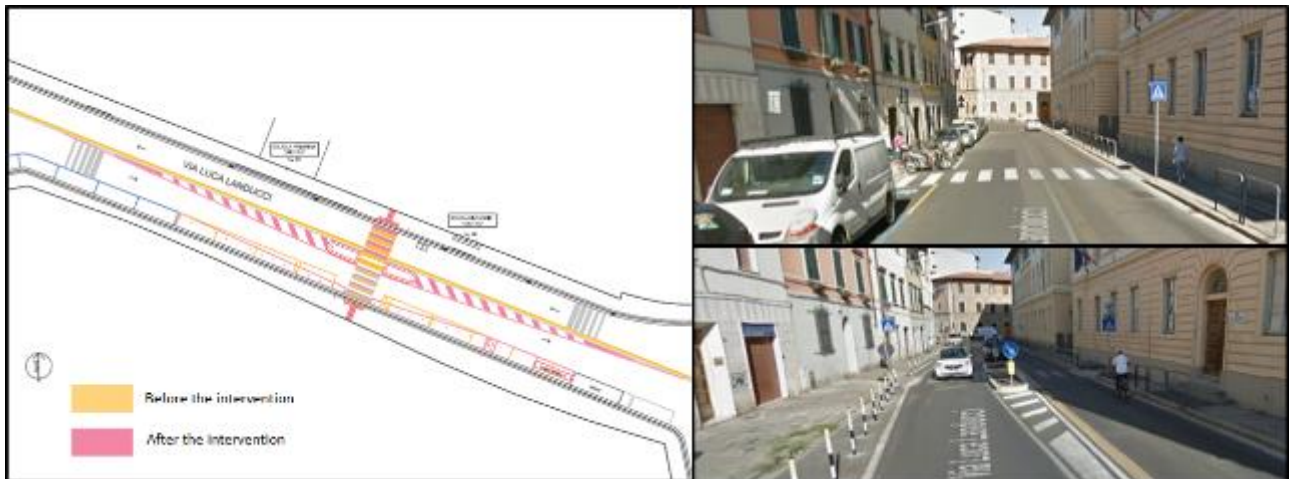

Figure 6.71 – Intervention on site 3, lane trajectory modification and parking lots removing [4] [5]

#### ○ KEY RESULTS/ACCOMPLISHMENTS

- Pedestrian refuge island in the middle of the road increase pedestrians' safety, giving them the possibility to cross the road in two times and so avoid risky crossings caused by high traffic: it is a protection from vehicles in the center of the road, while pedestrian are waiting for a safe gap in the second direction of traffic. Without a pedestrian refuge island, pedestrians must judge a safe gap between both directions of traffic at the same time making the crossing more difficult to carry out and may increase risk. Furthermore, pedestrian refuge islands generally cause a lane width reduction. This condition is often used as a traffic calming countermeasure because it has been verified that a lane narrowing lead drivers to slow down. The interventions presented in this case study have been implemented in recent years (2017) and so there are not yet available solid data concerning their effectiveness. However, the first analysis showed a good trend. Considering the literature and some analysis of previous implementations of this kind of countermeasures, it appears that pedestrian refuge islands are very effective at increasing safety for pedestrians crossing the road (an American research from Federal Highway Administration shows an accidents reduction of 40% [1]).
- Easy access for pedestrians with disabilities. Shaping sidewalks close to crosswalks in order to create access ramp for people with disabilities, increases safety. In this way, people with disabilities can follow the right path, without entering the roadway at points far from the pedestrian crossing, thus creating a high risk of accident.
- Parking area remodeling. Eliminating parking lots preventing pedestrians' visibility in correspondence of zebra crosswalks is a very effective safety measure. Both motorized vehicles and pedestrian benefit to these little improvement, especially if we consider crosswalks close to school: young people are always hard to be seen if they are behind a parked vehicle.

Together with the results illustrated in the previous points, the chosen countermeasure also influences the behaviour of drivers, according to the principles of the first rule of Human Factors [2]. The insertion of a pedestrian refuge island in fact changes the geometry of the cross-section

and also represents an anomalous physical obstacle in the middle of the road. This causes the user to increase his attention to that point, thus being able to realize the presence of a pedestrian crossing in time to adjust his speed.



*Figure 6.72 - Intervention on site 1, details of the crosswalk view at a 100 m distance: the white stripes are not visible in either picture, but in the second it is possible to clearly see the pedestrian refuge island [5]*

#### ○ POLICIES

The adopted countermeasures do not represent an innovation, because they have already been implemented in many other cities, including Florence, but it must be underlined that these interventions allow for inexpensive modifications of the infrastructure, which however have a high impact on safety (see table 11.1 of the Road Safety Manual or [3]).



#### ○ BARRIERS/OBSTACLES

This kind of interventions allows increasing pedestrian safety also in existing roads that, for such reason, must be modified generally with a low margin of intervention. Florence Municipality had made a detailed analysis of the possible solution to overcome the problem of pedestrians' safety without heavy impact on the road, especially considering both motorized vehicles safety and road functionality. It was found that pedestrian refuge islands are an intervention that meets both these needs.

#### ○ CONTACTS

monica.meocci@unifi.it

giuseppe.carone@comune.fi.it

andrea.palioetto@unifi.it

#### ○ REFERENCES

- [1] U.S. Department,, Federal Highway Administration, "Proven Safety Countermeasures – Median and Pedestrian Crossing Island in Urban and Suburban Area", 2011.
- [2] PIARC, "Human Factor guidelines for a safer man-road interface", 2016R20EN
- [3] PIARC, "Catalogue of design safety problems", 2009R07FR-EN
- [4] Comune di Firenze, delibere,
- [5] [http://www.comune.fi.it/export/sites/retecivica/comune\\_firenze/comune/atti\\_e\\_delibere/ode\\_web\\_del.htm](http://www.comune.fi.it/export/sites/retecivica/comune_firenze/comune/atti_e_delibere/ode_web_del.htm)
- [6] Google Maps

### 6.1.1.13. Safety intervention for the Strada Alzaia Naviglio Pavese Junction

#### ○ COUNTRY

Rozzano, Milan Metropolitan Area, Italy

#### ○ IMPLEMENTATION ORGANIZATION

Bike Pal Milano Team (Stefano Grillo, Giorgio Wetzl), European Transport Safety Council (ETSC) in collaboration with Rozzano Local Authority

#### ○ SUBJECT

Vulnerable Road Users intervention aimed at improving safety conditions, particularly for cyclists, at a high-traffic volume intersection in Rozzano, Milan Metropolitan Area. The case study was developed as part of Bike Pal Project 2013, a European Transport Safety Council's initiative (funded by the European Commission) aimed at improving cycling safety through information and awareness-raising to policymakers and through outreach to university students. The project proposed by Bike Pal Milano Team focused on the improvement of the road section layout, visibility and road signs, as well as on increasing awareness within the wider population about the multiple benefits (economic, cultural, transport, territorial development) that can arise from the promotion of cycling policies at local level.

#### ○ PROJECT DESCRIPTION AND SUMMARY

The project proposed by Bike Pal Milano Team was two-fold. Firstly, an infrastructure project was developed to improve cyclist safety in a high-danger location in Rozzano; secondly, a public event was organized to raise local awareness about topics surrounding cycling safety and sustainable mobility.

The infrastructure project was proposed for a highly-congested junction (Alzaia Naviglio Pavese junction), close to Assago and Milan's borders, as well as to other important local centers, and metropolitan and national infrastructure. Furthermore, the junction was located along the 35-km long Naviglio Pavese cycle path, which connects Milano to Pavia and the Ticino River.

On-site visits, personal experience of the junction, combined with an accident analysis undertaken by the Team, confirmed that the junction was amongst the most dangerous locations for cyclists in Rozzano. Accordingly, the Team developed a low-cost, highly-effective infrastructure proposal to improve the safety conditions of the junction based around three main devices/measures:

- Installation of horizontal and vertical road signs to signal the presence of the cycle path and related crossing;
- The restoration of the cycling crossing, possibly painted in red to improve visibility, and the installation of flashing traffic lights at the junction; and
- The use of posts to protect the crossing and avoid possible U-turns by vehicles.



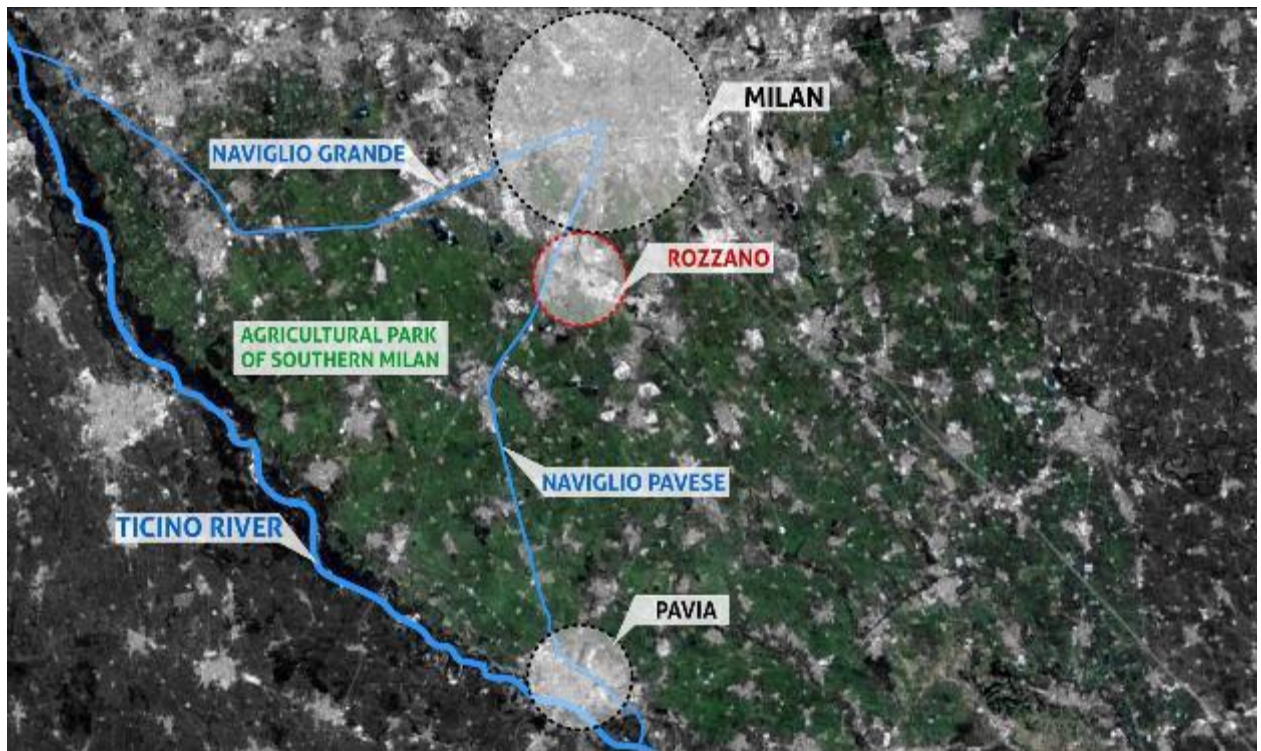

Figure 6.73 - Location map showing Rozzano within the wider Southern Milan Metropolitan Area

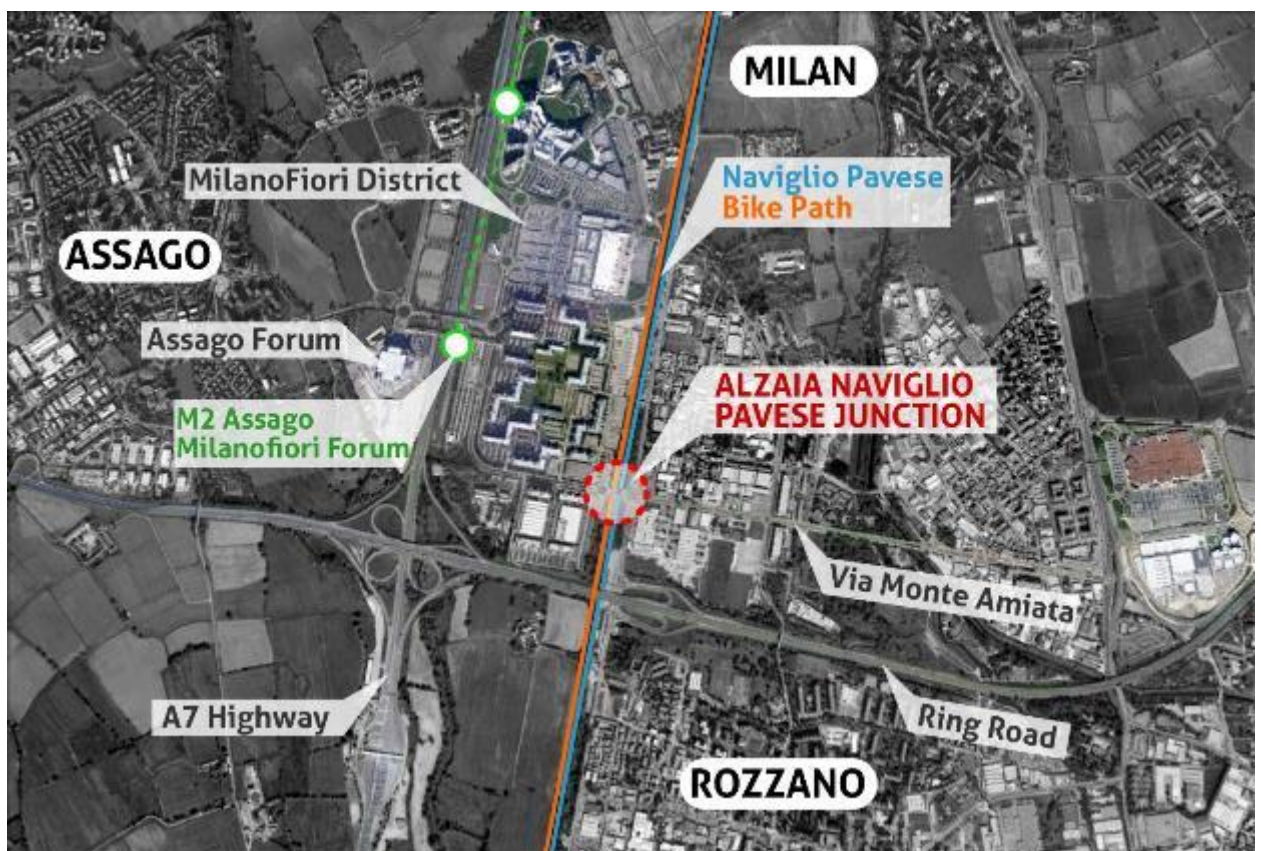

Figure 6.74 - Location map showing the Alzaia Naviglio Pavese Junction and nearby local centres, and infrastructure





*Figure 6.75 - Bird-eye view of the Alzaia Naviglio Pavese Junction (January 2013)*



*Figure 6.76 - Cyclist crossing the Alzaia Naviglio Pavese Junction (January 2013)*

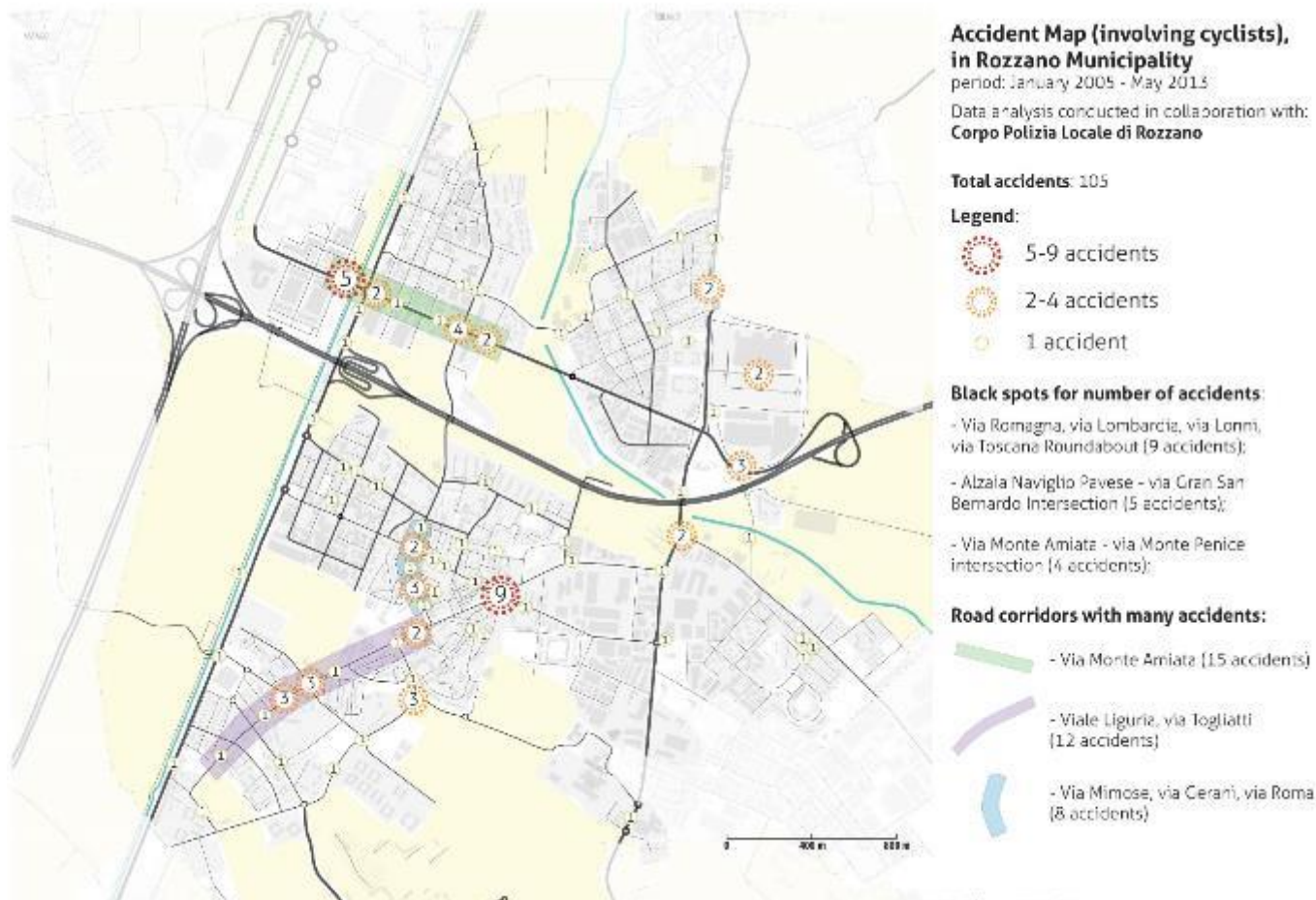

Figure 6.77 - Map showing the location of accidents in Rozzano, where cyclists were involved (January 2005 – May 2013)

The proposal was developed in April-June 2013, after which the Team began discussing it with the Technical Office of Rozzano Local Authority. The initial economic and technical analysis of the proposal were positive, although these highlighted few amendments needed for the proposal to be law-compliant and feasible (removal of the posts; crossing's painting postponed). The proposal was then included in a wider cycling project that Rozzano Local Authority was developing (bike lane in Via Monte Amiata) and for which it was applying for funding from Regione Lombardia. The project was effectively implemented in May-June 2014, once the technical and administrative procedures had been completed.

The second part of the project, which developed in December 2013-April 2014, focused on communicating the project and increasing local awareness about the multiple benefits of supporting cycling initiatives. The Team attended multiple meetings on the subject and contacted different stakeholders and organisations, with the aim of organising a public event in Rozzano. The public event called '*Cycling perspectives in the Southern Milan Metropolitan Area*', which focused on cycling safety initiatives, policies and good practice, was held on 12 April 2014.



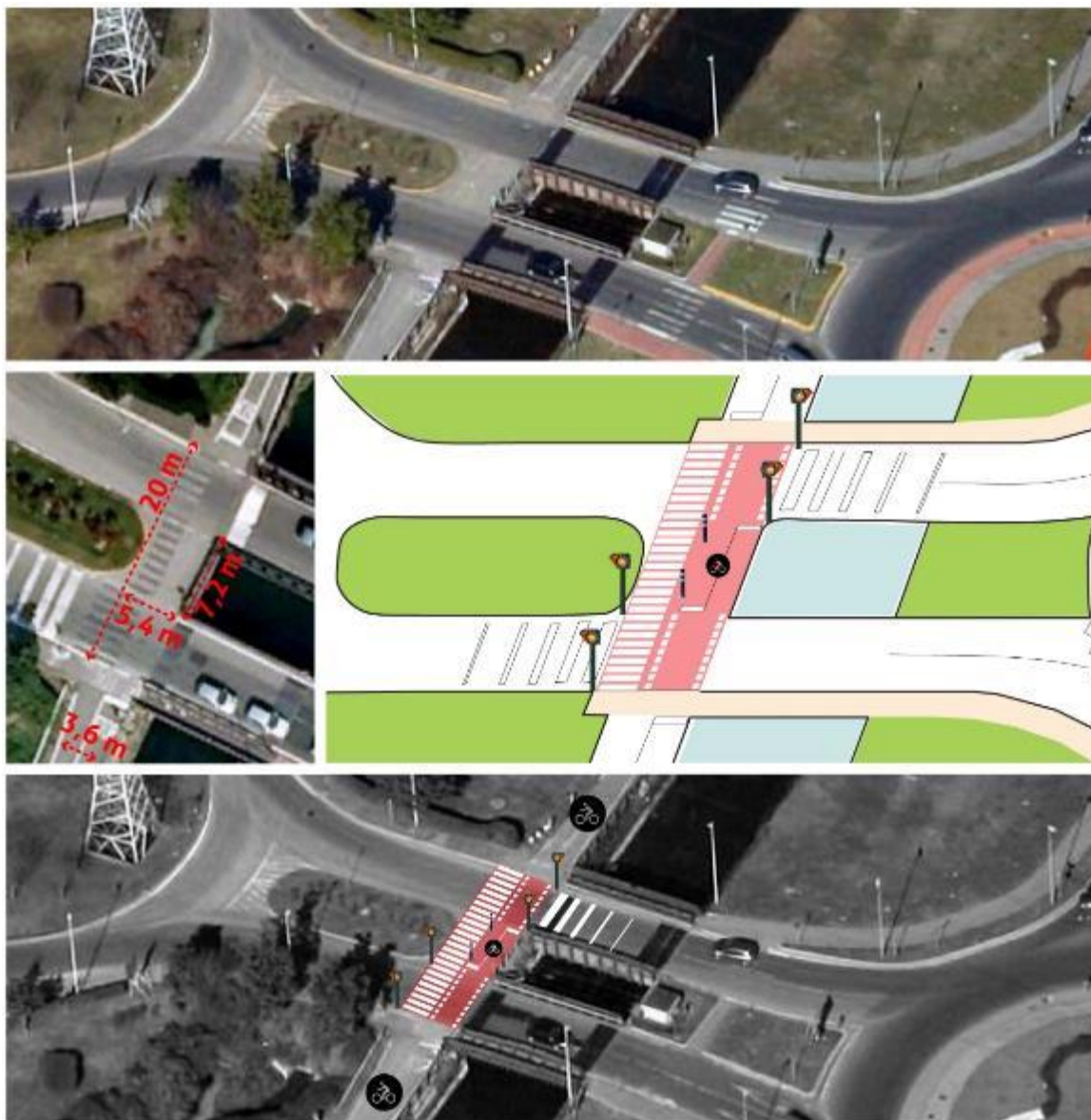

Figure 6.78 - Initial visualization of the Bike Pal Team's project proposal for the Alzaia Naviglio Pavese Junction (May-June 2013)



Figure 6.79 - Overview of the wider cycling project developed by Rozzano Local Authority (Alzaia Naviglio Pavese is identified in the red square 2)

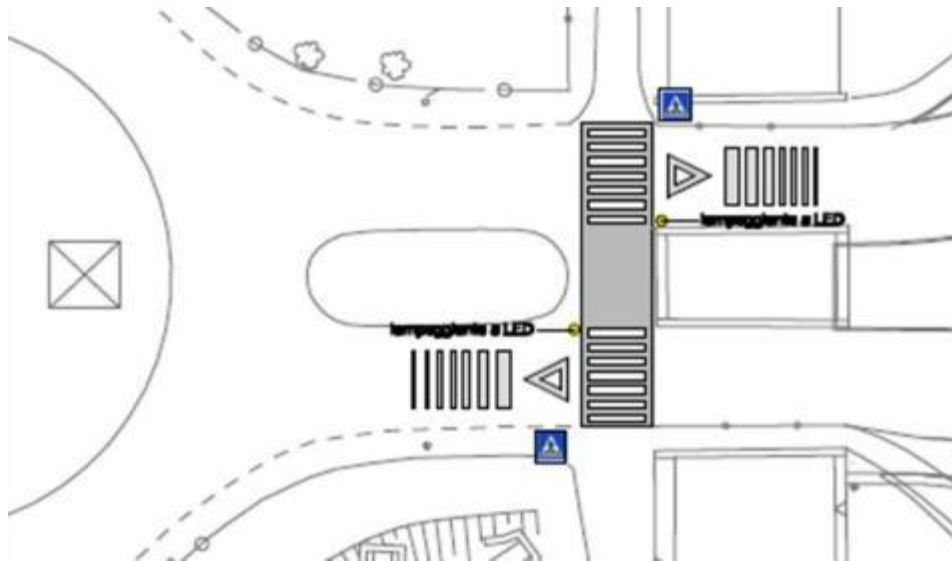

Figure 6.80 - Approved design layout for the infrastructural proposal at the Alzaia Naviglio Pavese

**incontro pubblico:**  
**PROSPETTIVE CICLABILI**  
**NELL'AREA SUD MILANESE**  
 progetti, politiche e buone  
 pratiche per favorire la mobilità  
 ciclistica

CON LA PARTECIPAZIONE DI:  
 Comune di Rozzano



**SABATO 12 APRILE 2014 - ore 9.30 - 13.00**  
**Centro culturale Cascina Grande**  
 via Togliatti - Rozzano

L'incontro vuole richiamare l'attenzione sulla mobilità ciclistica e sulle tematiche ad essa collegate, presentando alcune progettualità fisiche e di policy volte all'accrescimento dell'utilizzo della bicicletta e sottolineando l'importanza della sicurezza delle infrastrutture come condizione necessaria per l'esistenza e lo sviluppo di tale mobilità.  
 In particolare si vuole accrescere la consapevolezza riguardo gli ambiti che possono frangere sostanziali benefici dalla valorizzazione degli interventi a favore della mobilità ciclistica, la quale non deve più essere solamente associata a tematiche sportive o relative al tempo libero, bensì assumere sempre maggiore rilevanza in relazione a diversi aspetti economici, sociali, ambientali e culturali.  
 L'incontro approfondirà diversi progetti attivati, e in fase di completamento, caratterizzati da parziale discontinuità con gli approcci tradizionali al tema, sviluppati nel territorio sud milanese.

**Intervengono e discutono:**

- Amministrazione Comunale, saluto di Enrico Gaeta (Vice Sindaco di Rozzano);
- Stefano Grillo, Giorgio Wetzl (Progetto BikePal, Milano);
- Francesca Podda (ETSC, European Transport Safety Council);
- Emanuele Tonello (Politecnico di Milano);
- Antonio Pavarino (Direzione del Territorio Comune di Rozzano);
- Ass. Mario Burgazzi, Manuela Guffanti (Comune di Assago);
- Jacopo Zurlo (Touring Club Italiano);
- Mara Mazzari (Progetto In Bici a Scuola).

**Scienze organizzate:**  
 all'indirizzo del progetto europeo:  

 Teseo Milano  
 Stefano Cillo  
 Giorgio 20132

**Partner del:**  

 POLITECNICO DI MILANO

**Contatti per informazioni:**  
 [info@pal-milano.com](mailto:info@pal-milano.com)  
 Via Pal Milano Teso  
 Stefano 555 5756602  
 Giorgio 525 3769542

Figure 6.81 – 'Cycling perspectives in the Southern Milan Metropolitan Area' public event leaflet

#### ○ KEY RESULTS/ACCOMPLISHMENTS

The main accomplishment of the infrastructural project is surely the increased visibility of the cycling crossing, which caused an immediate and localised improvement for the safety of cyclists, who could be (and feel) more protected while crossing the Alzaia Naviglio Pavese junction.

Furthermore, the successful cooperation with Rozzano Technical Office was instrumental in raising the awareness on cycling safety issues within the local authority, also bringing wider attention to



the topic; in this way, this increased attention could then become an effective starting point to implement new policies and projects around cycling safety in Rozzano.



*Figure 6.82 - Photos showing the cycling crossing, vertical road signs, and flashing traffic lights at the project junction following the first phase completion (May 2014)*

The successful realization of the public event, where the wider benefits of cycling mobility and related safety policies were discussed, led to an increased engagement and awareness about the topic within Rozzano's population; as a consequence, this cultural change was expected to lead to positive long-term effects in the ways car-drivers and cyclists share the roads.

Finally, all the involved stakeholders (university students, professors, citizens, and the local authority) expanded their knowledge and awareness about how a project aimed at increasing the safety of vulnerable road users is developed and managed, from ideation until its effective realization.

#### ○ POLICIES

The main proposal developed by the Bike Pal Milano Team related to a low-cost infrastructure project capable of effectively improving safety conditions for cyclists in a specific location, reflecting the ETSC's requirements. Although new policies were not directly developed by the Team, the work undertaken also aimed at creating a better environment for the implementation of cycle-oriented policies in both Rozzano and nearby local authorities.

Specifically, the communication phase of the initiative (December 2013-April 2014) was aimed at improving local awareness (for both local communities and policy-makers) on the multiple benefits of investing in cycle-oriented initiatives and policies. The strategy deployed by the Team developed over three stages.

The first step was the Team's participation in a number of public events and conferences on cycling-related topics organised in the Milan Metropolitan Area by different organisations. This activity helped the Team in building a solid network of stakeholders, organisations, and expert professionals working on cycling initiatives in the Milan area, which would be later invited to the public event organised by the Team. Assago local authority, Touring Club Italiano, Team Galbiati, and Massa Marmocchi Milano were among the partners that had been successfully involved.

The second step, which built on the network the Team successfully put together, related to the interaction with the main Bike Pal project partners, these being Politecnico di Milano University, ETSC, and Rozzano local authority. Liaising with them, the Team started organising the public event, defining the debate's topic, identifying the list of potential speakers, and securing the venue. In order to promote the event and involve the local population, the Team advertised the event both on-line and in Rozzano, contacting local newspapers, and distributing leaflets to commercial activities, schools and the local population.

Finally, the public event was the occasion to present innovative projects, policies and good practices developed in the Southern Milan Metropolitan Area by a plethora of different organisations and stakeholders working on cycling topics. The invited speakers provided different 'perspectives' on the topic, and their involvement provided the opportunity, for both local communities and policy-makers, to develop a deeper understanding of the benefits of investing in cycle-oriented policies. Furthermore, the event was also an important networking opportunity for the involved stakeholders, as this could prepare the ground for future partnerships and cooperation between local authorities and cycling organisations on the topic, also in a cross-boundary perspective.



*Figure 6.83 - Photos of the public event 'Cycling Perspectives in the Southern Milan Metropolitan Area' held on 12 April 2014 at the Cascina Grande Cultural Centre (Rozzano)*

#### ○ BARRIERS/OBSTACLES

The obstacles that arose during the development of the proposed project mainly concerned the relation with the local authority, particularly in terms of convincing and leading the local authority to effectively implement the proposed infrastructural solution. It is indeed emblematic that gaining the local authority's confidence had been a lengthy process for the Team, while once all the involved parties agreed on the content and value of the proposed intervention, and related communication campaign, the project was then completed with just minor impediments.

The time required for completing the needed administrative processes before the effective realisation of the infrastructural project was unexpectedly long, requiring almost 6 months more than what was originally foreseen; this was mostly due to the time needed for the local authority to complete the application process for accessing Regional funds. Subsequently, when the application process had been successfully completed and the proposed project had been declared eligible for Regional funds, it took additional time for completing the necessary administrative procedures (such as public procurement) before the works could effectively start.

Finally, the lack of a ‘cycling culture’ in Rozzano and the limited involvement of local citizens on cycling topics was an additional barrier to overcome, especially in the process of searching for local partners and organisations that could support the Team in lobbying Rozzano Local Authority.

#### ○ LESSONS LEARNED

The main lesson learned from the project was about the crucial role that an effective communication campaign could play, not only in promoting the realisation of a new project but also in giving the final push for its completion.

Initially, the Team’s strategy was to prioritise the realization of the infrastructural safety measures and then to communicate the findings, analysis and proposed solutions to the wider public. However, what the Team found out, and later applied, was that bringing forward the public event could help in lobbying the local authority in a faster and better way, as the direct involvement of citizens worked as an incentive for the local authority to act.

In this way, remarkable importance could be recognised to the creation of a wide network of stakeholders and professionals providing different points of view on the topics of cycling safety and, more broadly, cycling mobility. Furthermore, the presentation of these different perspectives on the topic provided the context for the proposed infrastructural project, eventually supporting its goals and effective realisation.

#### ○ COSTS

The wider infrastructure project developed by the Rozzano Local Authority, which also included the Bike Pal Team’s proposal for the Alzaia Pavese Naviglio Junction, had an estimated cost of around €82,000. The main costs related to the construction of a 2km-long cycle lane in Via Monte Amiata, which comprised the installation of new red tarmac, protective kerb and road signs (both vertical and horizontal), the re-organisation of three pedestrian crossings, and the construction of road bumps near the pedestrian crossings.

Accordingly, and considering the higher costs for realising the new 2-km long cycle lane in Via Monte Amiata, the Team’s proposal for the Alzaia Naviglio Pavese Junction is estimated to be cost in the region of €5,000-10,000, although accurate estimates were not provided by the local authority at the time.

#### ○ CONTACTS

Stefano Grillo: [stefano.stegrillo@gmail.com](mailto:stefano.stegrillo@gmail.com)

Giorgio Wetzl: [giorgio.wetzl@gmail.com](mailto:giorgio.wetzl@gmail.com)

#### ○ REFERENCES

- [1] Bike Pal – Promoting best practice in cycling safety ([ETSC](#))
- [2] Safety intervention for the Strada Alzaia Naviglio Pavese junction – Rozzano, Milano ([Final report](#), June 2014. Stefano Grillo, Giorgio Wetzl)
- [3] Safety intervention for the Strada Alzaia Naviglio Pavese junction ([Project presentation](#), October 2016. Stefano Grillo, Giorgio Wetzl)
- [4] Bike Pal, premiatio il Comune di Rozzano ([Press release](#), October 2014. Comune di Rozzano)



#### **6.1.1.14. Sidewalks advancement to improve pedestrian visibility**

○ COUNTRY

Italy

○ IMPLEMENTATION ORGANIZATION

Municipality of Florence

○ SUBJECT

The case study is a series of three interventions aimed at improving the safety of pedestrians crossing the road. The safety improvement is achieved by advancing the sidewalk at and near the zebra crossing.

○ PROJECT DESCRIPTION AND SUMMARY

Two of the three crosswalks interested by the intervention are crosswalks in correspondence of schools. Although no fatal or particularly serious accidents were detected along these road segments, however, it was noted as a consequence of users reports and experts' analysis, that some deficiencies related to road safety are present, particularly concerning the difficult visibility of pedestrians in the process to cross. This is even more aggravated by the fact that very often the pedestrian was represented by a child, whose smaller figure can more easily remain hidden behind a car parked immediately before the crosswalks.

The aim of the interventions was to improve the visibility of pedestrians who are about to cross the road, through the advancement of the sidewalk both in correspondence and in the zone immediately preceding the zebra crossing.

The intervention in the third site also allowed to redefine the road section. The lane crossed by the zebra crossing, has a single direction of travel. Before the intervention, the lane was too wide. This not only encouraged drivers coming from Via Faentina to increase speed, but also gave the opportunity to vehicles coming from Via Cuoco, who turned left, to partially enter the lane, remaining in the middle of the yield line, creating critical issues not only to the passage of vehicles from Via Faentina, but also to the pedestrian crossing, obscuring the view of any pedestrian waiting to cross.



Figure 6.84 - Site 1. On the right top the situation before the intervention, on the bottom the situation after the intervention [1] [2]



Figure 6.85 - Site 2, situation before the intervention (in the centre) highlighting two cars parked immediately before the two zebra crossing, and situation after the intervention (on the right) [1] [2]

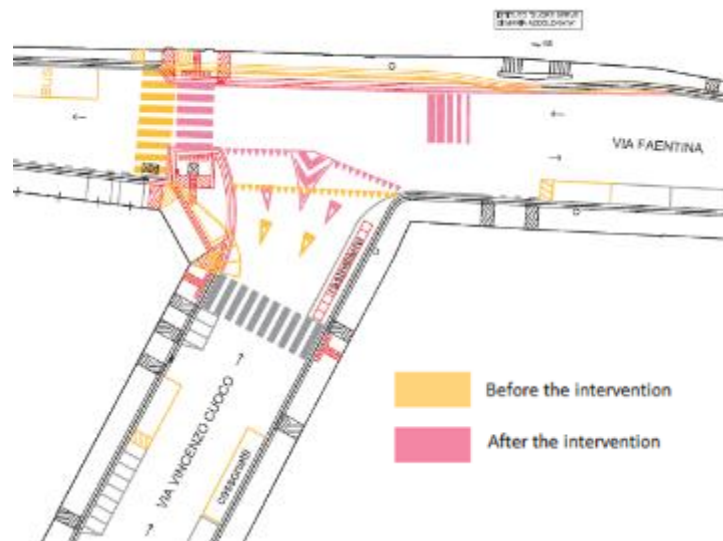

Figure 6.86 - Site 3, scheme of the intervention [1]



Figure 6.87 - Site 3, on the left situation before the intervention, on the right situation after the intervention [2]



Figure 6.88 - Site 3, details of the intervention [2]

#### ○ KEY RESULTS/ACCOMPLISHMENTS

Three years after the intervention there were no accidents within the intervention areas. However, there is a noticeable improvement in the visibility of the crossing, which corresponds to an increase

in road safety. The interventions have also made it possible to guarantee sidewalks accessibility to people with reduced mobility.

#### ○ POLICIES

The countermeasures adopted do not represent an innovation, because they have already been implemented in many other cities, including Florence, but it is very useful to underline that these interventions allow for inexpensive modifications of the infrastructure, which however have a high impact on safety.

#### ○ BARRIERS/OBSTACLES

This type of countermeasures allows increasing pedestrian safety even on existing roads which, for this reason, must be modified having generally a low margin of intervention available. The Municipality of Florence has carried out a detailed analysis of the possible solutions to overcome the problem of pedestrian safety without having heavy repercussions on the functionality and on the road layout. The sidewalk advancement on crosswalks with a lack of visibility, is an intervention that meets both these needs.

#### ○ CONTACTS

[monica.meocci@unifi.it](mailto:monica.meocci@unifi.it)

[andrea.palioetto@unifi.it](mailto:andrea.palioetto@unifi.it)

#### ○ REFERENCES

[1] Comune di Firenze, delibere, [http://www.comune.fi.it/export/sites/retecivica/comune\\_firenze/comune/atti\\_e\\_delibere/ode\\_web\\_del.htm](http://www.comune.fi.it/export/sites/retecivica/comune_firenze/comune/atti_e_delibere/ode_web_del.htm)

[2] Google Maps



### ***6.1.1.15. Installation of “Soft” Rising Bollard to eliminate through traffic from school route***

#### ○ COUNTRY

Japan

#### ○ IMPLEMENTATION ORGANIZATION

Road administration

#### ○ SUBJECT

This is a case where Rising Bollard was installed to protect the children passing through the school route. This Rising Bollard rise only during the child’s school hours and prohibit the passage of vehicles other than permitted vehicles. The permitted vehicle can lower the Rising Bollard by remote control operation.

This Rising Bollard uses a rubber bollard to prevent the vehicle from becoming a serious accident in the event of a collision. Even for "Soft" Rising Bollard made of rubber, it completely restrained the passage of vehicles during school hours (100% decrease).

#### ○ PROJECT DESCRIPTION AND SUMMARY

On the road in the residential area, in order to protect children and pedestrians and others, measures such as prohibiting the passage of cars are carried out. However, from the role of the road and the circumstances of the surrounding road network, it is sometimes difficult to prohibit the passage of all vehicles at all times. In response to such a problem, it is considered effective to set up the Rising Bollard used in Europe and elsewhere, and to eliminate through traffic by permitting passage of vehicles at specific vehicles or specified time zones.

Even in Japan, we have been studying mainly on research group of universities to use Rising Bollard.

The Rising Bollards made of steel used in Europe may cause damage to vehicles and road structures and serious accidents at the time of a vehicle collision. Therefore, in Japan, we are developing and spreading "soft" Rising Bollard which rubber bollard is used.

Hiyoriyama district, Niigata City is the first area in Japan the district where Rising Bollard was installed on the road inside residential area that is used for school route.

In this area, the number of cars for commuting increases in the morning hours, and the main road is congested. To avoid that traffic jam, the number of cars also increases in the roads in the residential area. Part of the road where the number of vehicles increases is also dangerous for children as there are roads used by children walking.

Therefore, we decided to install “Soft” Rising Bollards in one location on the road in the residential area. This Rising Bollard rise only during the child’s school hours and prohibit the passage of vehicles other than permitted vehicles. The permitted vehicle can lower the Rising Bollard by remote control operation.

As a result of the countermeasures, the traffic concentrated on weekday morning school hours has been drastically reduced, contributing to safety during commuting.

### ○ KEY RESULTS/ACCOMPLISHMENTS

Even for "soft" rising bollard made of rubber, it completely restrained the passage of general vehicles during school hours (100% decrease). As a result, it is considered that the safety of the students going to school has been secured in the target road.



Always descending except in the traffic regulation time zone. Large vehicles (excluding micro) can not be passed at all times  
 Figure 6.89 - Installation status of Soft Rising Bollard. Made by MLIT HP  
 Regulations on traffic on weekdays 7: 30-8: 15 (school time zone)  
<http://www.mlit.go.jp/road/road/traffic/sesaku/torikumi.html#2-2-4>

### ○ POLICIES

- You can regulate vehicle traffic in the time zone by road structure (not by traffic regulation)
- We adopted elastic soft material in the main body, and tried to decrease the number of traffic accidents

### ○ BARRIERS/OBSTACLES

- It is necessary to apply traffic regulation at the same time, and adjustment is necessary when road administrator and traffic manager are different
- The introduction cost per part is large (several million yen)

### ○ CONTACTS

ozaki-y82ac@mlit.go.jp

### ○ REFERENCES

- [1] MLIT HP (<http://www.mlit.go.jp/road/road/traffic/sesaku/torikumi.html#2-2-4>)
- [2] MLIT HP Countermeasure examples  
 Introduction Guidelines 2015 (IATSS)  
<http://www.iatss.or.jp/common/pdf/research/h2643Guideline.pdf>
- [3] International Association of Traffic and Safety Sciences Research investigation (IATSS) report material in 2017

### 6.1.1.16. Proposals for Potential Countermeasures in LMICs

#### ○ COUNTRY

Madagascar

#### ○ IMPLEMENTATION ORGANIZATION

Ministry of Public work / Madagascar Road's Authority/ *Charge of Itineraries in Road Maintenance Division*

#### ○ SUBJECT

The executed project is part of Routine Maintenance, which is maintained every year. The program is generally in year (n-1), the objective according to the guideline of the Ministry of Public Works is to have a program of routine maintenance of the national network optimized and rational and the objective principal being: "ENSURE ROUTINE MAINTENANCE OF THE NATIONAL ROAD NETWORK".

For the development of the Routine Maintenance Program of the National Roads Campaigns (n-1), the following specific objectives should be taken into consideration:

- 1 - The conservation of the road heritage;
- 2 - The right level of service to the user (including user safety);
- 3 - Maintaining the continuity of the economic routes.

#### ○ PROJECT DESCRIPTION AND SUMMARY

The objective of the project apart from the routine maintenance stated is to treat the first accidentogenic points on the RN4 axis, in the district of "Ankazobe", axis under my responsibility, under the directive of the Ministry of Public Works.

The implementation is between September 2017 and March 2018.

#### ○ KEY RESULTS/ACCOMPLISHMENTS

The main results for the recently completed campaign are to gradually solve the points susceptible to accidents: we have treated four points after an interview with the National Gendarmerie: first three points accidentogenic and a point that we noticed during our monitoring of the network.

The points treated are in the rural area and at the cornering.

To do this, we first put vertical signals:





- - Attention panel,
- - Donkey panel,
- - Turning panel,

So that the breakers can be used wisely, that is to say, so that the breakers are not obstacles or create new accidents, two horns were placed before these breakers.

Added to these, a horizontal signalling "attention" was marked on the ground, to warn users.

PK 121+050_RN4	
BEFORE	AFTER
	
<p><i>Traces of wheels on the roadway</i></p>	<p><i>Countermeasures : set up two horns and speed breaker</i></p>
	
<p><i>Reverse Direction view</i></p>	<p><i>Before the horns, set up: three panels: turning, attention, donkey</i></p>
	
<p><i>Several traces of glass debris</i></p>	<p><i>Panel + ground mark: attention and panel donkey</i></p>



PK 71+500_RN4	
BEFORE	AFTER
	
<p><b>At this point:</b> if two trucks intersect: one of the trucks (on the side of the photo) falls in this ravine. Cause: narrow road, excessive speed, lack of visibility: since double turn</p>	<p>panel: attention and donkey + sign mark attention</p>
	
<p>Reverse Direction view</p>	<p>set up two horns</p>
	
	<p>and speed breaker</p>

	<p><i>On the opposite side: we also put these same facilities</i></p>
	<p><i>Project: widening the roadway at this point</i></p>
<p>PK 105+000_RN4</p>	
<p>BEFORE</p>	<p>AFTER</p>
	
<p><i>Parapet destruction: sign of accidents</i></p>	<p><i>Setting up panel: big bend</i></p>
	
	<p><i>Parapet repair and painting with In the opposite direction, (descent): alarms + overwidth</i></p>
	
	<p><i>In the opposite direction, (descent): alarms + overwidth</i></p>

PK 160+100_RN4	
BEFORE	AFTER
	
<p><i>A sign posted by the deceased's family in memory of his 2014 accident</i></p> <p><i>Accident of a truck around 7pm, without crossing the other direction.</i></p> <p><i>Cause: excessive speed, lack of visibility (night), bend</i></p>	<p style="text-align: center;">1. Set up attention and turn panel 2. Registration on a turn marking road</p> <p style="text-align: center;"><i>Project : adding turn tags</i></p>
	
<p><i>The panel, more closely</i></p>	

○ POLICIES

No, but in general, the maintenance policy, as stated in question 05, is based on the following three points:

- - the preservation of the road heritage;
- - The good level of service to the user (including the safety of users);
- - The maintenance of the continuity of the economic routes.

This maintenance policy is intended for those responsible for the itinerary (Ministry of Public Works and Road Authority of Madagascar) during the programming (n-1).

1- The preservation of the road assets to know: “Cantonnage” to better clean the water on the roadway - project "Zero pothole" - maintenance of structures.

2- The good level of service to the user (including the safety of users):

It is generally the exploitation: painting of the panels, beacons or putting or putting back of the beacons, marking on the ground. **It is in this context that between road safety.**

3- Maintaining the continuity of the economic itineraries whose treatment focuses on the points likely to cut off the road: crossings and crossings etc.

In addition to our meeting that allowed us to be aware of this security of users.

#### ○ BARRIERS/OBSTACLES

Since their set-up, we have not noticed any accidents at the 4 points treated so far in the winding dangerous curves.

#### ○ LESSONS LEARNED

That the road of Madagascar whose conception and construction, was done at the time of the colonization, between 1920-1940, is very sinuous and narrow especially at the levels of the turns.

1. Today's trucks have larger, longer gauges and are difficult to negotiate in turns, especially if two trucks cross each other. One of the trucks should stop because the other is more than half the width (average width = 5.50m and in turns: average width = 6-8m) of the road or to cross in turns, the two trucks crush the existing shoulders. Otherwise, if they do not pay attention, they make accidents.

2. The new cars have more and more efficient engines, and as the drivers like to test the performance of their cars, they are also lost in the turns and very often the cars that transport people make this kind of accident: drivers drive too fast.

At first, horns and speeders with signalling for these dangerous points are the best solutions while waiting for a correction of these points: increase of the width of pavement and attenuation of the sinuosity and finally removal of these breakers for the comfort users.

Users are dissatisfied with these solutions adopted today, but essential for their security first.

#### ○ COSTS

The approximate cost per point is 4,000 euros.

#### ○ CONTACTS

[dm.ratsimavo@live.fr](mailto:dm.ratsimavo@live.fr) or [dm.ratsimavo@arm.mg](mailto:dm.ratsimavo@arm.mg)



### **6.1.1.17. Road Safety Inspection of Highway MEX-057 Queretaro-San Luis Potosi**

#### ○ COUNTRY

Mexico

#### ○ IMPLEMENTATION ORGANIZATION

The Road Safety Inspection (RSI) was implemented by researchers from the Transport Safety and Operation Coordination of the Mexican Transportation Institute.

The construction of the Pedestrian Crossing-Grade Separation was carried out by the private sector.

#### ○ SUBJECT

Pedestrian crosswalk, Highway MEX-057 Queretaro-San Luis Potosi, Kilometer 9+000 to 27+900, Suburban Zone of Queretaro.

Pedestrian Crossing-Grade Separation. During the Road Safety Inspection carried out on the highway section, a provisional pedestrian crossing-grade separation was found that connected both sides of the highway, at kilometer 12 + 100, in whose adjacent areas there are two commercial malls, one on each side of the highway, where important work and entertainment centers are located. The proposed improvement measure was the construction of a final pedestrian crossing-grade separation, which meets the objectives of providing vulnerable users an infrastructure for safe circulation in the area.

The present success story shows the risk situation detected in 2015 and the impact of the implementation of the improvement measure as of 2016.

#### ○ PROJECT DESCRIPTION AND SUMMARY

The studied road section is part of one of the most important road corridors in the country (from Mexico City to Nuevo Laredo City). It is located at inner suburbs area, is a transport axis whose cross section consists of three lanes of circulation per direction in the main lanes and of three additional side lanes, each of 3.3 m width. Has a right paved shoulder of 0.50 m of width and a physical median with of 2 m; the site is on a tangent stretch with an average longitudinal slope of 3%.

The side lanes have a speed limit of 60 km/h, while in the central lanes the speed limit is 80 km/h. At the moment they circulate by the highway, that is crosses by the pedestrian crossing-grade separation analyzed, an average of 81,500 vehicles by daily per direction and the historical tendency shows a rate of increase of 4.8% annual, due to the development of the area. It is because of these characteristics that it is vitally important to avoid pedestrian crossing at level.

One of the most controversial sites for pedestrians was detected at km 12+100 because it is situated in an area where malls are located on both sides of the road.

The analysis of accidents corroborated the occurrence of road accidents in this place. For the period between 2013 and 2017, the Local Police reported 38 road accidents in the area where the pedestrian crossing-grade separation is located, while the Federal Police reports 53 road accidents in the same zone, resulting in a total of 91 accidents in the period analyzed, reporting itself on average 18 accidents every year. Of the 91 traffic accidents, five correspond to run over by vulnerable users, leaving as balance 6 people injured and one deceased.

During the Road Safety Inspection carried out, it was observed the existence of a provisional pedestrian crossing-grade separation bad designed and in bad conditions. The proposed

improvement measure was the construction of a permanent pedestrian crossing-grade separation; it was constructed during 2016 and is currently in function.

○ KEY RESULTS/ACCOMPLISHMENTS

The pedestrian crossing-grade separation currently works adequately providing a service to 562 pedestrians/hour, most of them are adult women between 20 to 40 years old.

The construction of the pedestrian crossing-grade separation is justified due to the high speeds reported in the road. Operating speeds between 85 to 90 km/h were recorded on the side lanes of the road and between 112 to 122 km/h for the central lanes. It was observed that more than 80% of the drivers that transit in this area exceed the speed limit.

So far, there has been a recorded reduction in the run over victims. In the last 2 years since the start of operation of the pedestrian crossing-grade separation, there has been a single victim compared to the six recorded in the previous 3 years. However, there are still risky behaviours by pedestrians crossing the road below the pedestrian crossing-grade separation passing through a pedestrian fence that has not continuity providing to the pedestrian an opportunity to cross by it.



*Figure 6.90 - Provisional Pedestrian Crossing-Grade Separation detected during the RSI*



*Figure 6.91 - Detail of pedestrians using the provisional Pedestrian Crossing-Grade Separation*



*Figure 6.92 - Panoramic view of the permanent Pedestrian Crossing-Grade Separation, seen from the east side*



*Figure 6.93 - Access ramp to the Pedestrian Crossing-Grade Separation, east side seen from the north view*



*Figure 6.94 - Side view of the Pedestrian Crossing-Grade Separation, seen from the east side*





*Figure 6.95 - Interior view of the Pedestrian Crossing-Grade Separation*



*Figure 6.96 - Access ramp to the Pedestrian Crossing-Grade Separation, west side seen from the south view*



*Figure 6.97 - Access ramp to the Pedestrian Crossing-Grade Separation, west side seen from the north view*



### ○ POLICIES

As a result of the Road Safety Inspection carried out on the road section, there is no knowledge of the creation of new public policies regarding pedestrian crossings. However, in the Transportation Program of Queretaro State 2016-2021, which is a state public policy, contemplates the modernization of road infrastructure to incorporate the new public transportation axis, which considers the construction of bus stops and spaces for pedestrians that include, among other things, the improvement of lighting and sidewalks.

### ○ BARRIERS/OBSTACLES

Three main obstacles were recognized: the behaviour of users, the access to information and the lack of regulations that establish the need to implement Road Safety Inspections. With regard to user behaviour, risk behaviours were detected in some pedestrians who, despite having a pedestrian crossing-grade separation, do not use it and risk their lives crossing the road at level, which indicates the lack of road culture by the vulnerable users, since in Mexico there is not an educational program of culture and road safety implemented. Only in some states, training is required to obtain licenses for motorists and freight vehicles, and at the federal level, only professional drivers require mandatory training for the obtaining of licenses, the rest of users do not have the training and information necessary to be responsible users, aware of their obligations and rights within the road system. In relation to access to information, a legal void was found regarding the jurisdiction for the construction, supervision, conservation and operation of the pedestrian crossing-grade separation, since it is not well defined if it corresponds to the municipality, the state or the federation to take charge of the matters related to it. On the other hand, permits for land use and development of mall centers were granted by the municipality, however the highway in question is of federal jurisdiction, but because it is located within the limits of state territory the conservation it is in charge of the state government. For these reasons, the authors of the present work failed to determine who is responsible for the design and construction of the pedestrian crossing-grade separation in study.

Finally, with regard to the lack of regulations for the implementation of RSIs, this inspection was carried out by the authors' initiative, which represented a challenge when gathering the information necessary to carry out it, since the municipal, state and federal authorities do not contemplate RSI programs for their roads now.

### ○ LESSONS LEARNED

It is necessary to implement educational programs started in the basic level to have responsible users, aware of their obligations and rights when using the road system. It is important to implement Road Safety Inspections throughout the road network and in all areas, rural, urban and sub-urban. The application of RSI in a formal way and by law will bring benefits in the improvement of the infrastructure, directing efforts to provide greater road safety to all users, being responsible for the application of said improvements, the parties involved in the design, the construction and operation and maintenance of the road infrastructure. An RSI Manual for federal highways is currently in development.

It is also necessary to review the regulations on the allocation of land use permits and, on the construction, conservation and operation of the toll free road sections, so that there are no disputes about the responsibilities of the three levels of government on any type of infrastructure for vulnerable users.

- COSTS

The approximate cost Pedestrian Crossing-Grade Separation's construction was \$350,000.00 USD.

- CONTACTS

Emilio Abarca: [eabarca@imt.mx](mailto:eabarca@imt.mx)

Nadia Gómez: [ngomez@imt.mx](mailto:ngomez@imt.mx)

Alberto Mendoza: [mendoza@imt.mx](mailto:mendoza@imt.mx)

Gerardo Rios: [grios@imt.mx](mailto:grios@imt.mx)

- REFERENCES

- [1] Austroads (2002). Road Safety Audit. Second Edition. Standards Australia. Sydney, Australia. ISBN: 0-85588-589-0.
- [2] Gobierno del Estado de Querétaro (2017). Programa Estatal de Transporte Querétaro 2016-2021 (PETQ). Querétaro, Querétaro. México.
- [3] <http://www.iqt.gob.mx/wp-content/uploads/2017/02/Programa-Estatal-de-Transporte.pdf>
- [4] Cal y Mayor R. E., R, Cárdenas Grisales, J. (2007). Ingeniería de Tránsito, Fundamentos y aplicaciones, Octava Edición, Editorial Alfa Omega, México. ISBN: 970-15-1238-3.

### **6.1.1.18. Road Safety Inspection of the Free Federal Highway Mexico-Toluca (MEX-15)**

#### ○ COUNTRY

Mexico

#### ○ IMPLEMENTATION ORGANIZATION

Mexican Transportation Institute, Ministry of Communications and Transportation

#### ○ SUBJECT

Number and severity of accidents

#### ○ PROJECT DESCRIPTION AND SUMMARY

Because it represents one of the most conflicting road sections in Mexico, the Ministry of Communications and Transportation decided to carry out a Road Safety Inspection (RSI) on the free federal highway Mexico-Toluca.

This road is part of a commercial corridor constructed in 1952 that connects Mexico City with the border city of Nogales. The inspected section communicates the metropolitan areas of Mexico and Toluca, first and fifth most populated areas in the country with 20.1 and 1.9 million inhabitants respectively. The analyzed section is 30 kilometers in length (from km 22 to 52) and has an Annual Average Daily Traffic (AADT) ranging between 54 and 127 thousand vehicles. It also has a percentage of heavy vehicles of 15%. The average annual growth rate of traffic on this road is 5%. In the original right-of-way of the highway, a toll road and the Mexico-Toluca intercity passenger train have been built. In addition, the expansion of the urban areas, the linear settlements along the road and the lack of maintenance have generated a complex operation not contemplated on the original design, producing serious road accidents problems. Each year in this section occur about 100 severe collisions, causing 20 deaths and 60 serious injured, with an economic cost of 14 million dollars.

Many of the deficiencies of this road, as they are related to its geometry, cannot be detected with the traditional inspection procedures at the user visibility level, but a detail aerial view is also required. This work describes the findings of a RSI practiced, based on:

- the conventional approach of progressive field revision in both directions, both day and night, relying on checklists, the taking of videos and frames with Hawkeye 2000 equipment, and the collection of operational traffic data (on accidents occurred, vehicular flows, etc.); and
- the obtaining of the detailed geometry of the road, and its cartography, from LIDAR flights and the handling of this information using computational tools for the geometric design of roads.

The objective of the project was to detect the root problems of the road, in order to propose adequate countermeasures according to its present and future demand and operation, taking into consideration the feasibility indicators for the economic investment required. The findings show the type of road safety problems that are generated on highways whose function has changed over the years (from an interurban to a suburban arterial).





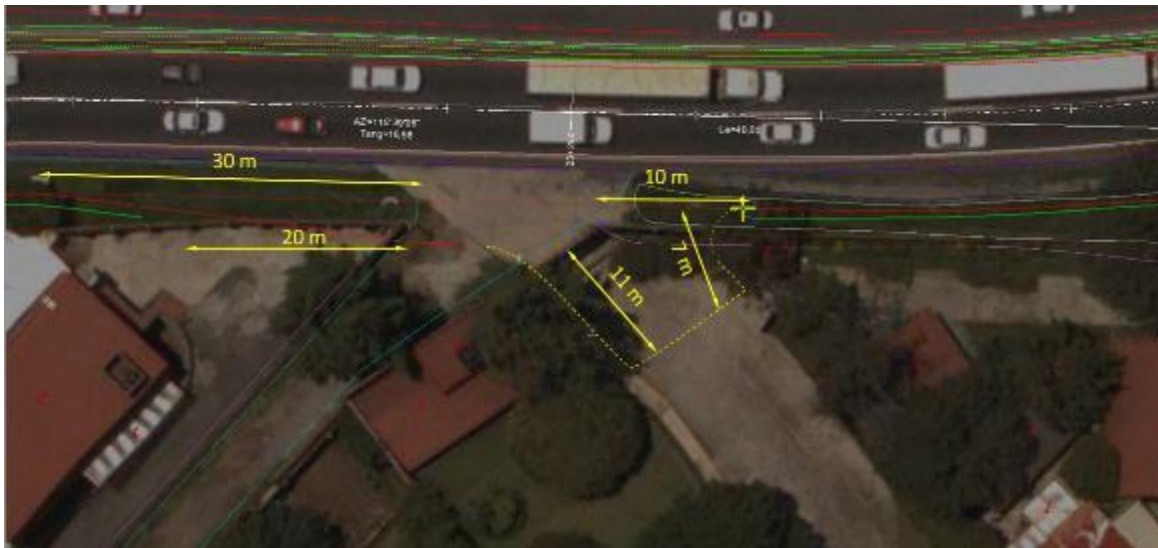

Figure 6.101 - Access control problems.



Figure 6.102 - Visibility problems.

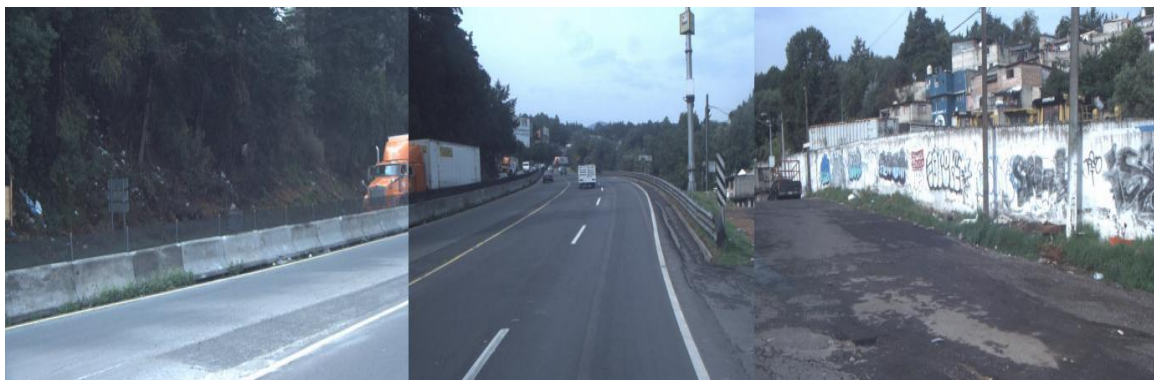

Figure 6.103 - Hazardous metallic barrier terminations and direct connectivity with private properties.



Figure 6.104 - Safety problems at public transport stops.

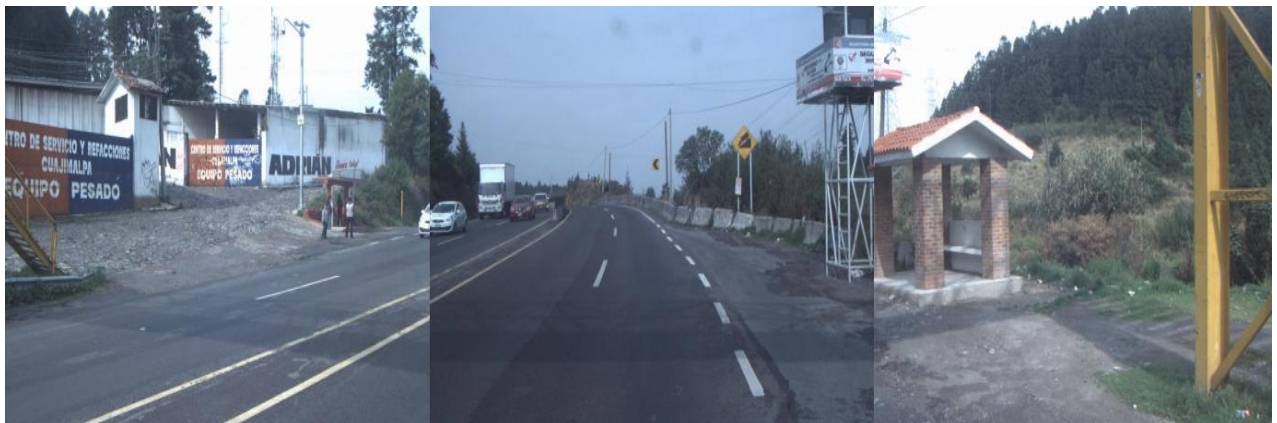

Figure 6.105 - Safety problems at public transport stops.

#### ○ KEY RESULTS/ACCOMPLISHMENTS

Safety deficiencies were identified on 169 high-risk sites (potential or manifest). On 48 of them, the deficiencies and improvements were determined based on the RSI done from the user's perspective. They correspond to short-term actions, such as access density reduction, installation of lateral and central barriers, proper barrier terminations and damping devices, roadside hazards removal, installation and improvement of public transport stops, improvement and construction of pedestrian infrastructure (over bridges, crossings, sidewalks, among others), signing and markings, lighting, skid resistance improvement.

Type of countermeasure	Cost (million dollars)	Annual results of the countermeasures			Operating Speed (km/h)	Speed reduction which produces the same results
		Deaths avoided	Serious injuries avoided	Benefit/Cost Ratio		
Short-term	14	10	27	2.67	80	11.7%
Medium and long term	38	10	33	1.10	80	13.3%

Table 6.2 – Benefits group by type of countermeasure

On the other 121 sites, the deficiencies and improvements were identified through the aerial perspective. All of them correspond to medium and long-term actions such as superelevation corrections; widening of the shoulders to increase the stopping sight distance; improve the weaving sections, horizontal and vertical curves, connections with the toll motorway; improvement and

installation of acceleration and deceleration lanes; adapt the highway layout to accommodate the new passenger train. Table 6.2 summarizes the results derived from the improvement of the 48 sites corresponding to short-term interventions, as well as of the 121 sites related to geometric corrections to perform in a medium and long-term. The detailed road safety benefits of the specific countermeasures in each site can be found in Reference 1.

#### ○ POLICIES

Currently an official Road Safety Audit/Inspection (RSA/I) Manual is being developed. This Manual will obligate the practice of this important tool on the road projects and in-service roads in the Mexican Federal Road Network, which is the principal road network of the country. The Manual considers the realization of the conventional user level RSI and of the aerial view analysis in cases like the one described in this document.

#### ○ BARRIERS/OBSTACLES

In Mexico, the decision-making authorities on road infrastructure do not visualize yet the importance of the RSA/I, given its preventative nature. This represents, in such a way, one of the main obstacles to improve safety of the national road infrastructure. The information generated with this type of tools contributes to greater success in obtaining the funds required to materialize the countermeasures.

#### ○ LESSONS LEARNED

The main lesson learned is that, when it comes to old roads, their RSI should not be limited to traditional methods based on field visits – at the risk that the resulting measures result insufficient for effectively improve road safety – but also the analysis of greater detail of its geometry should be included. The latter, given that there are a diversity of aspects that through the years change substantially in relation to the conditions prevailing when the road was designed. Currently, many old roads have an unsafe geometry because they were designed with overdue design standards, for slower, less powerful, smaller and lighter vehicles, smaller density of accesses, lower vehicular and passenger flows, pedestrian and economic activity, interaction with other roads, etc. In this case, the intention to improve the safety of the road led to consider also the upgrading of its geometrical attributes, drainage, etc.

#### ○ COSTS

The proposed countermeasures have an approximate cost of 52 million dollars.

#### ○ CONTACT:

[mendoza@imt.mx](mailto:mendoza@imt.mx)

[mcadengo@imt.mx](mailto:mcadengo@imt.mx)

#### ○ REFERENCES

- [1] Dorado, M., et al., 2018. Recommendations for the Road Safety Inspection of In-Service Roads, Technical Publication, Mexican Transportation Institute.

### **6.1.1.19. Arranging a pedestrian crossing on DN 28, in Valea Lupului, Iași county**

#### ○ COUNTRY

Romania

#### ○ IMPLEMENTATION ORGANIZATION

C.N.A.I.R. S.A. – D.R.D.P. IAȘI through S.D.N. Iași and

The representatives of The City Hall of Iași Municipality

#### ○ SUBJECT

The road section on DN 28 km 67 + 600 where the pedestrian crossing was arranged was rehabilitated between 2000 and 2003, the road being designed with four lanes, two on the way, separated only by road markings. As a result of the increase in traffic values of both transit traffic and traffic attracted as a result of the socio-economic explosion of the area, the number of collisions in the sector adjacent to this point increased, so an analysis of the events that have led to the need to improve safety, especially for vulnerable road users, by building a pedestrian crossing.

#### ○ PROJECT DESCRIPTION AND SUMMARY

The road sector DN 28 km 0 + 000 - km 68 + 170 was the object of the national roads rehabilitation works carried out during the period 2000 - 2003. According to these works, the geometrical features of the cross section of the road were designed as follows:

- 2 lanes x 3.50 m each, one/direction
- 2 reinforced shoulders with the role of emergency lane x 2.50 m, one per each direction.

Also, the geometrical characteristics of the cross section of the road, on the km 65 + 170 km 68 + 050 were designed as follows:

- 4 lanes x 3.50 m each, two strips per direction
- 2 x 0.50 m shoulders, one for each direction.

At the time of finalizing the respective works, considering the road traffic data, including the pedestrians, which were the basis for the elaboration of the technical project, the traffic directions were not physically separated, through guard rails, and along the entire length of the settlement only 2 (two) pedestrian crossings were projected – at km 66 + 000 and at km 66 + 570. These pedestrian crossings were arranged in the simple solution – without refuge central island.

Between 2004 and 2009 there was a constant and strong growth of the local economy and the local conjuncture (the right side of the road was included in the urban area of Iași and the left side - inside the Valea Lupului municipality) led to a massive urban development of the area in the vicinity of the national road.

In this situation, there was a strong increase in the volume of traffic on the European road, reaching the first class of traffic (MMA>21,000 standard vehicles/day). Simultaneously with the economic development of the area, the urban growth also occurred, on the left side of the road being developed an important residential area.

Taking into account the dynamics of road accidents from 2005 to 2009, it has proved necessary to reconsider the way of organizing the road traffic on the road sector inside the Valea Lupului



commune. The solutions that were adopted were the separation of circular traffic across the town by placing New Jersey concrete safety fencing with  $H = 1.00$  m, width at the base being 64 cm.



*Figure 6.106 – Before the first intervention: lanes without newjersey separation*



*Figure 6.107 – Before the second intervention: a pedestrian crossing the road in the wrong way, section 1, lasi oriented view*



*Figure 6.108 – Before the second intervention: section 2, Iași oriented view*



*Figure 6.109 – Before the second intervention: road section 2, Valea Lupului oriented view*

In this situation, due to the urban development of the area, the flow of pedestrians increased as well as their demand to cross the European Road. Under these conditions, coupled with the significant number of road traffic collision victims among this category of vulnerable road users, there has been the problem of building bridges for pedestrians, thus separating the flow of pedestrians from road traffic. However, this solution also encountered implementation difficulties, given the need for collaboration between the local councils of Valea Lupului and Iași Municipality.

Therefore, in the first stage, as a provisional solution, it was decided to arrange a pedestrian crossing at km 67 + 600, at the same level.

Setting up a pedestrian crossing by separating walking directions with a pedestrian central rest island so that the pedestrian will cross the road in two stages. A traffic light system was also considered, but due to very high road traffic, this feature was not implemented.

The location of the pedestrian crossing was established considering the demand for public transport, close to a residential neighborhood. The details of pedestrian crossing arrangements, as can be seen in the attached diagram, are as follows:

- The central island is raised - because of the high traffic of freight cars, it was chosen the protection solution for pedestrians waiting on the island at a higher level than the national road
- Overall design length = 65.00 m
- Length of space on the island available to pedestrians = 9.00 m
- The width of the central island = 2.00 m
- Width of space available for crossing pedestrians = 4.00 m
- Crossing is done by changing the direction of travel - in "S"
- Space available for pedestrians on the island is bounded by pedestrian fence
- Signals for pedestrian crossing have been designed with intermittent yellow light, both on the right-hand side of the road and those installed on the central island.
- The traffic speed in the pedestrian crossing area was limited to 30 km/h.



*Figure 6.110 – During the intervention: construction site section 1, Iasi oriented view, details of the pedestrian refuge island*



*Figure 6.111 – During the intervention: construction site section 2, Iasi oriented view*





Figure 6.112 – During the intervention: construction site section 1, Iasi oriented view



Figure 6.113 – After the intervention: road section 2, V Lupului oriented view

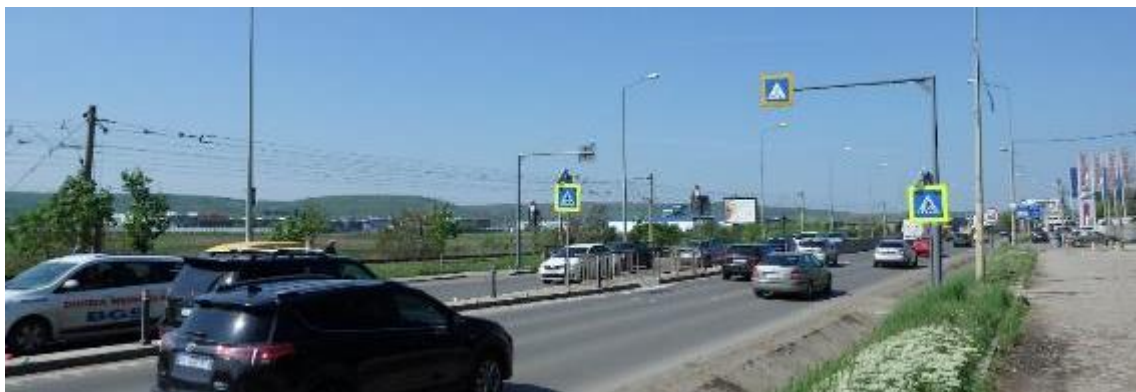

Figure 6.114 – After the intervention: road section 1, V Lupului oriented view





*Figure 6.115 – After the intervention: road section 1, V Lupului oriented view, details of the pedestrian refuge island*



*Figure 6.116 – After the intervention: road section 1, Iasi oriented view*



*Figure 6.117 – After the intervention: road section 1, lasi oriented view, details of the pedestrian refuge island*

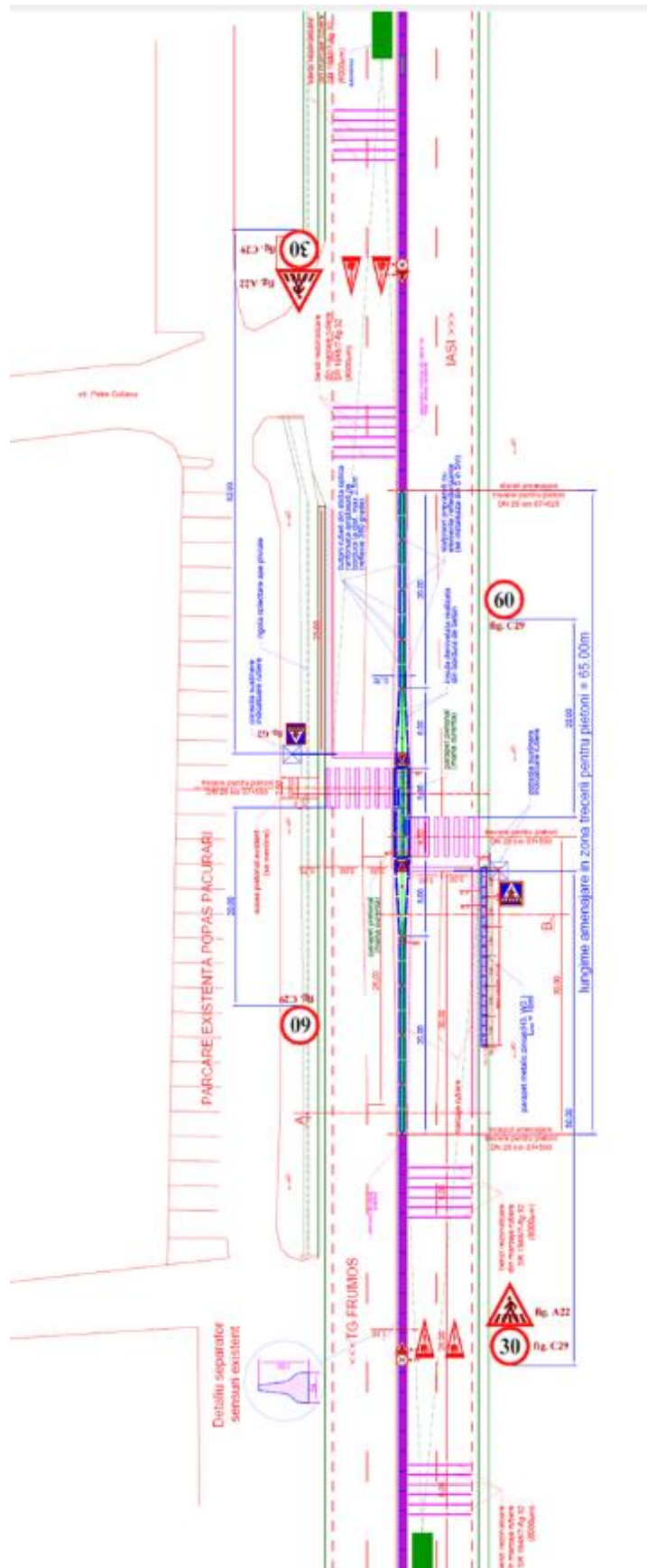

Figure 6.118 – Pedestrian crossing design

## ○ KEY RESULTS/ACCOMPLISHMENTS

The dynamics of road accidents on DN 28 inside the Valea Lupului commune is as follows:

Period	Road sector	Collisions	Victims	
			Deceased people	Seriously injured
2005 - 2009	64+600 - 65+000	5	2	3
2010 - 2015		4	2	2
Total		9	4	5
2005 - 2009	65+000 - 66+000	9	4	9
2010 - 2015		1	0	1
Total		10	4	10
2005 - 2009	66+000 - 67+000	10	4	9
2010 - 2015		6	0	6
Total		16	4	15
2005 - 2009	67+000 - 67+900	5	5	6
2010 - 2015		3	1	2
Total		8	6	8
TOTAL 2005 - 2015	65+100 - 67+900 Length = 3.300 km	43	18	38

Table 6.3 - Dynamics of road accidents on DN 28 inside the Valea Lupului



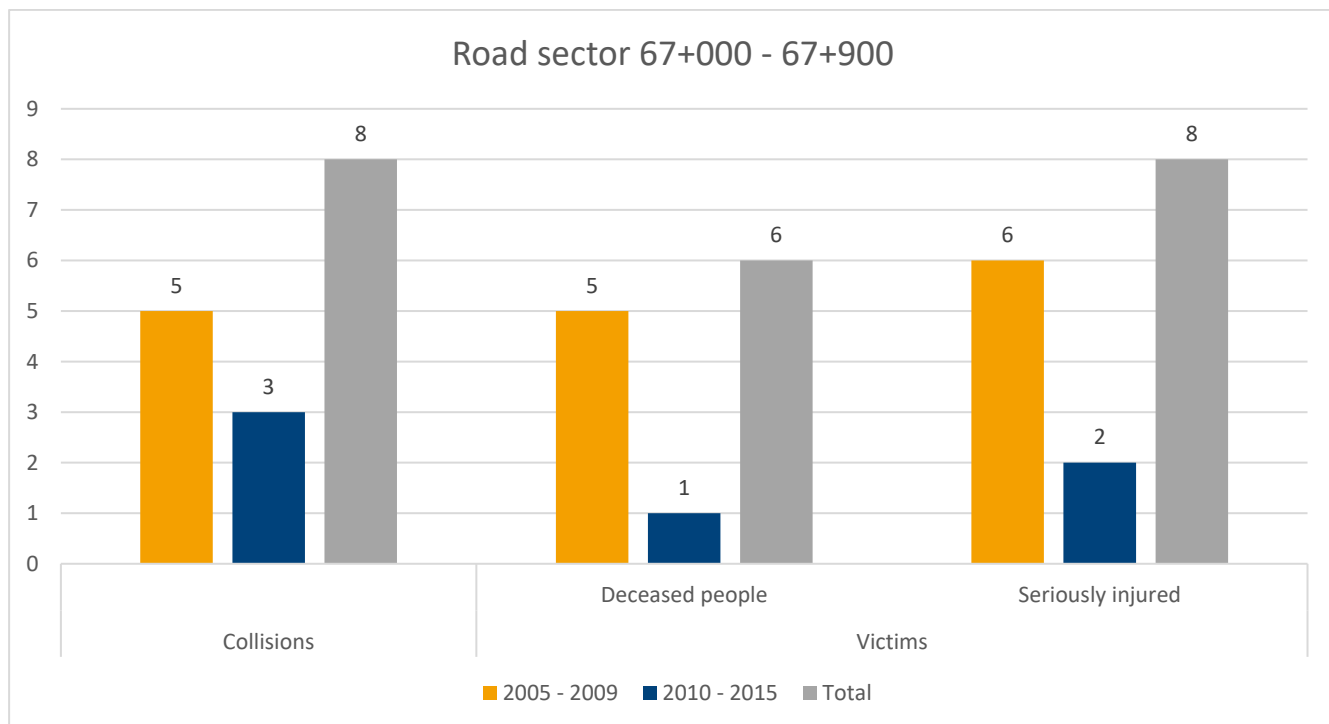

Graph 6.1 – Accidents statistics in section km 67+000 – km 67+900

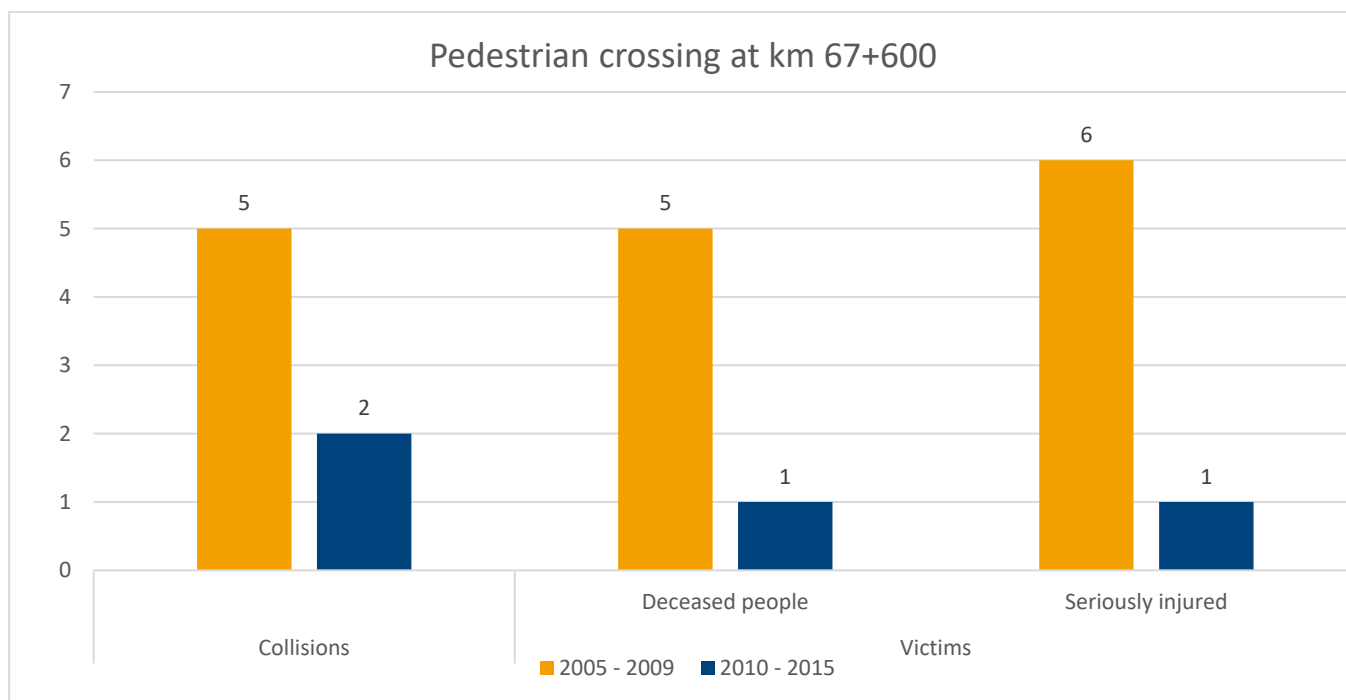

Graph 6.2 – Statistics concerning the accidents on the pedestrian crossing km 67+600

In comparison, the following information on collisions between 2005 and 2015 was recorded in the areas related:

Period	Road Sector	Collisions	Victims		Observation
			Deceased people	Seriously injured	
2005 - 2009	67+450 - 68+000	5	5	6	Pedestrian crossing at km 67+600
2010 - 2015		3	1	2	
2005 - 2015	Length of 0.550 km	8	6	8	

*Table 6.4 - Dynamics of road accidents in the area of the pedestrian crossing*

#### ○ POLICIES

By realizing the arrangement, it was intended that the pedestrians would cross the national road in two stages and the vehicles would move at a reduced speed in the pedestrian crossing area, so as to increase the protection of the vulnerable users to the other traffic participants.

This vision came as a result of tracking the way pedestrians crossed the area, sometimes running, as well as the behaviour of drivers after the installation of the central parapets - the speed of travel in the crossing of the locality increased, which is also due to the impossibility of detection of exceeding legal speeds by radar police installed on cars traveling from the opposite direction.

#### ○ BARRIERS/OBSTACLES

In order to achieve this arrangement, it was necessary to cooperate very well between:

- Road Police as an institution responsible for managing road events and the one holding information on collisions produced in the area;
- the Regional Directorate of Roads and Bridges in Iași, together with the National Road Section of Iași, as the administrator of the respective road and responsible for ensuring safe traffic conditions;
- Iași City Hall representatives - as a safety entity for the inhabitants of the neighborhood and manager of the local public transport routes.

This co-operation has, in some places, encountered some bureaucratic obstacles that have, however, been overcome by the benevolence of the actors involved.

Once the causes of the collisions have been established, through the cooperation process described above, the solution has been developed jointly and the implementation was carried out by R.D.R.B. Iași through N.R.S. Iași and the Iași City Hall representatives, after its approval by the Police Road Service Iași.

#### ○ LESSONS LEARNED

The design phase did not take into account the real increase of the traffic values in the sector DN 28 Tg. Frumos - Iași, nor the economic and social development of the transited localities, especially in the suburban area of Iași, so that the number of pedestrian crossings in Valea Lupului was under-dimensioned and the modality of the design was projected only through the specific, simple marking. As traffic has grown enormously and trafficking has become more and more aggressive, vulnerable road users have become more and more exposed, especially when it is necessary to

cross this heavily circulated artery. In order for such situations not to be designed in this way, we consider that it is imperative that at least all the major road works (national roads, county roads, communal roads), respectively rehabilitation works, capital repairs, modernization, building new roads, etc. to be thoroughly analyzed, including by carrying out the Road Safety Impact Assessment and Road Safety Audit, so as to identify and correct, from the feasibility study phase, the deficiencies that may lead to serious the operation of road infrastructure.

Thus, if the traffic evolution on the Tg. Frumos - Iași road sector had been correctly estimated, as well as the social and economic growth of the transit areas, could have been scheduled for execution, possibly staged, of uneven passages and pedestrian paths totally physically separated from the national road so as to be minimized as much possible conflicts between transit traffic and vulnerable users.

○ COSTS

50.000 euros including VAT (approximate costs)

○ CONTACTS

Iulian-Cătălin Dimache [catalindimache@yahoo.com](mailto:catalindimache@yahoo.com)      [catalin.iulian.dimache@gmail.com](mailto:catalin.iulian.dimache@gmail.com)

Ștefan Dinco      [stefd2005@yahoo.com](mailto:stefd2005@yahoo.com)

### **6.1.1.20. Re-arrangement of a pedestrian crossing on DN 28, in Bălțați, Iași county**

#### ○ COUNTRY

Romania

#### ○ IMPLEMENTATION ORGANIZATION

C.N.A.I.R. S.A. – D.R.D.P. IAȘI prin S.D.N. Iași

#### ○ SUBJECT

The road section on which the pedestrian crossing is located has been rehabilitated during the period 2000-2003, the road being designed with two lanes and the projected width of the platform having the value of 12.00 m. As a result of the increase of the traffic values, both transit traffic as well as traffic attracted as a result of the socio-economic development of the area has increased the number of collisions at this point, so an analysis of these events has been carried out, as a result of which it became necessary to improve the degree of safety for road traffic, especially for vulnerable road users, by specially arranging the pedestrian crossing in the center of the locality.

#### ○ PROJECT DESCRIPTION AND SUMMARY

The road sector DN 2 km 254 + 000 - km 282 + 300 was the object of the national roads rehabilitation works carried out during the period 2000 - 2003. According to these works, the geometrical features of the cross section of the road were designed as follows:

- 2 lanes x 3.50 m each, one/sense

- 2 reinforced shoulders with the role of emergency lane x 2.50 m, one per sense

In 2003, at the end of the works, taking into account the data underlying the technical design, the pedestrian crossing was set at km 36 + 100, in the simple solution, correlated with the current road marking application standard.

We mention that this is the only pedestrian crossing arranged in the administrative center of Bălțați (where they are located: the Town Hall of the commune, the school, the police station, the Cultural House, the medical cabinet), which has the length of 3.725 km of road, sector km 35 + 103 - km 36 + 458.

Against the background of the strong increase in traffic volume on the European road - from class III traffic in 2000, to traffic class I (MMA > 21,000 standard vehicles / day) in 2010 - in the area of pedestrian crossing, there was an increase in the number of collisions, accompanied by an increase in the number of victims, especially among pedestrians.

It has therefore become necessary to reconsider how to arrange pedestrian crossing. Two solutions have been evaluated:

A. Building a pedestrian bridge and sidewalks along DN 28 to safely guide the flow of pedestrians to the bridge.

B. Arranging the pedestrian crossing by separating the walking directions with a forbidden space, prior to the location of the passage and directing traffic on the circulating lane, in the crossing area, as the traffic also takes place on the reinforced platforms, as well as the application of warning strips of cross- high-volume road markings.



For economic and legal reasons, version B was adopted, and, depending on the financial possibilities, the realization of a pedestrian bridge was also considered.



*Figure 6.119 - Design detail for a pedestrian crossing in the rehabilitation works on DN 28*



*Figure 6.120 - Redesigning the pedestrian crossing in Bălțați locality*



*Figure 6.121 - Km 35+850*



*Figure 6.122 - Km 35+875*



*Figure 6.123 - Km 35+925*



*Figure 6.124 - Km 35+975*





Figure 6.125 - Km 36+000



Figure 6.126 - Km 36+050



Figure 6.127 - Km 36+075



*Figure 6.128 - Km 36+090*



*Figure 6.129 - Km 36+100*



*Figure 6.130 - Km 36+150*





Figure 6.131 - Km 36+200



Figure 6.132 - Km 36+225



Figure 6.133 - Km 36 + 110 - reverse traffic direction (Iași - Tg. Frumos)

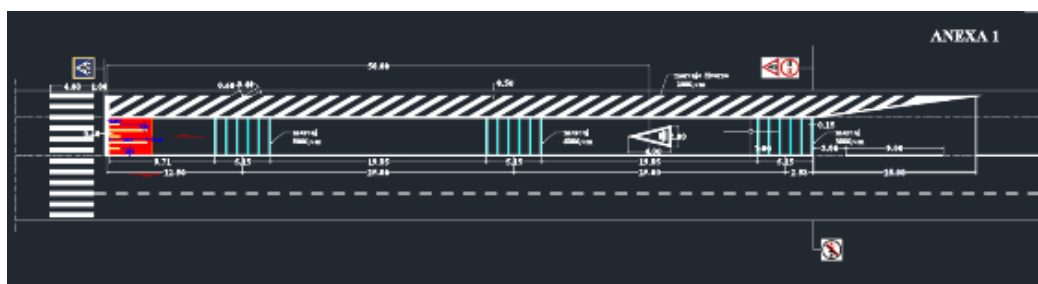

Detail design for arranging pedestrian crossings in linear localities on roads with a platform of 12.00 m

#### ○ KEY RESULTS/ACCOMPLISHMENTS

So far, the first stage has been achieved and a slight reduction in the number of collisions in the pedestrian crossing area (17%) has been observed, but the reduction among the deceased has been halved.

The dynamics of road accidents in the affected area, respectively, on the DN 28 km 35 + 500 - km 36 + 500, was the following:

Period	Collisions	Victims	
		Deceased people	Seriously injured
2005 – 2008	6	2	4
2009 - 2015	5	1*	4

\* The cause of the accident in which the death was recorded the irregular crossing of a pedestrian at a distance of 300 m.

*Table 6.5 - Dynamics of road accidents in the affected area*

#### ○ POLICIES

By accomplishing that arrangement, it was intended that the movement of vehicles would be conducted only on the circulating lanes, not on the lateral lanes for accidental parking, as well as at low speed, in order to provide increased protection for vulnerable road users, compared to the other participants in the traffic. This vision has come as a result of tracking the road traffic on roads rehabilitated with a 12.00 m platform, where the high traffic values led to use the accidental parking lanes as well as traffic lanes.

#### ○ BARRIERS/OBSTACLES

In order to accomplish this arrangement, it was necessary to cooperate very well between the Road Police, on the one hand, as an institution responsible for managing traffic events and the one that holds the information regarding the collisions produced in the respective area and the Regional Directorate of Roads and Bridges Iași, together with National Road Section of Iași, on the other hand, as the administrator of the respective road and responsible for ensuring the conditions of safe traffic, according to the laws in force. This co-operation has, in some places, encountered some bureaucratic obstacles that have, however, been overcome by the benevolence of the actors involved.

Once the causes of the collisions have been established, through the cooperation process described above, the solution has been developed jointly and the implementation was carried out by R.D.R.B. Iași through N.R.S. Iași, after its approval by the Police Road Service Iași.

#### ○ LESSONS LEARNED

The design phase did not take into account the real increase of the traffic values in the sector DN 28 Tg. Frumos – Iași, as well as the economic and social development of the transit localities, so that the pedestrian crossings in these localities were designed only by the specific, simple marking. As traffic volume has grown enormously, as trafficking is becoming more and more aggressive,

vulnerable road users have become the most exposed, especially when it is necessary to cross this heavily circulated main road.

In order for such situations not to be designed in this way, we consider that it is imperative that at least all the major road works (national roads, county roads, communal roads), respectively rehabilitation works, capital repairs, modernization, building new roads, etc. to be thoroughly analyzed, including by carrying out the Road Safety Impact Assessment and Road Safety Audit, so as to identify and correct, from the early design phases, the deficiencies that may lead to serious events in the road infrastructure operation stage.

Thus, if the traffic evolution had been correctly estimated, on the road sector Tg. Frumos - Iași, as well as the social and economic growth of the transit areas, could have been planned works for the execution of some bypasses of the localities or, as a cheaper variant, the construction of some uneven passages and pedestrian paths, completely separated physically from national road, so as to minimize as much as possible conflicts between transit traffic and vulnerable road users.

○ COSTS

30.000 euros including VAT (approximate costs)

○ CONTACTS

Iulian-Cătălin Dimache

[catalindimache@yahoo.com](mailto:catalindimache@yahoo.com)

[catalin.iulian.dimache@gmail.com](mailto:catalin.iulian.dimache@gmail.com)

Ștefan Dinco

[stefd2005@yahoo.com](mailto:stefd2005@yahoo.com)

### 6.1.1.21. *Bicycle passages and bicycle crossings*

#### ○ COUNTRY

Sweden

#### ○ IMPLEMENTATION ORGANIZATION

Swedish Transport Administration and various municipalities.

#### ○ SUBJECT

Traffic safety at bicycle passages and bicycle crossings.

#### ○ PROJECT DESCRIPTION AND SUMMARY

The project studies the consequences of a change in traffic law. In the 1st September 2014 the traffic law changed in Sweden. The change meant, among other things, that the concept of bicycle crossing was introduced and defined, with rules for the yield towards cyclists who are on or just traveling on a bicycle crossing, a new road sign and requirements for local traffic regulations. In addition, it was stipulated that the traffic environment should be designed so it is not possible to drive vehicles at speeds higher than 30 km/h.

The Swedish Transport Administration initiated a project - Secure Bike Crossings - with the aim of developing advice and requirements for the design of bicycle crossings and bicycle passages. In cooperation with this project, Swedish Association of Local Authorities and Regions (SKL) have formulated proposals for design for municipalities: "Municipal Practice Cycle Crossings and Cycle Passage" (published in Swedish May 5, 2017, on the webb: <https://skl.se/samhallsplaneringinfrastruktur/trafikinfrastruktur/cykeltrafik/reglerforcykeltrafik.6266.html>)

In summary, bicycle crossings provide a high level of accessibility for cyclists where the design is made according to the regulations and with speed calming to 30 km / h. The effects are probably best if multiple bicycle crossings are done simultaneously, in continuous stretches of priority bicycle-stretches. A recommendation from the project is also that a strategy for information - both locally and nationally - should be presented. People has poor knowledge of what a bicycle crossing is. This is confirmed in road-side interviews.

#### ○ KEY RESULTS/ACCOMPLISHMENTS

Work has been done in the project to investigate the possible impacts of road users on road safety and accessibility.

Summary:

- Studies of yielding show that a well-designed speed-reduction on bicycle crossings gives about 90 percent yielding rate by motorists, compared to about 30 percent before – with no yielding and no speed-reduction (today's bicycle passages).
- "Before and after study" is done on the base of police reported accidents in STRADA (Swedish Accident Information System) until May 2017 in 81 locations at 8 municipalities. It gave a decrease from 0.06 to 0.02 accidents per place crossing and year. The before-period is 1199 months, after-period is 185 months. The accidents are few, and the change is therefore not statistically significant.



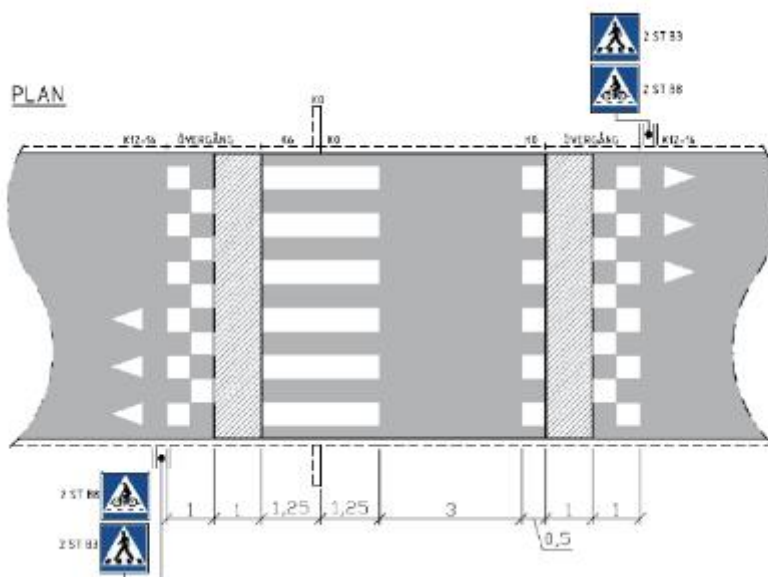

Figure 6.134 – Example of the design of a bicycle crossing with pedestrians crossing and speed reduction (speed



Figure 6.135 - Realization of a bicycle crossing with pedestrians crossing and speed reduction (speed humps). Source: City of Helsingborg

#### ○ POLICIES

In the 1st September 2014 the traffic law changed in Sweden. The change meant, among other things, that the concept of bicycle crossing was introduced and defined, with rules for the yield towards cyclists who are on or just traveling on a bicycle crossing, a new road sign and requirements for local traffic regulations. In addition, it was stipulated that the traffic environment should be designed so it is not possible to drive vehicles at speeds higher than 30 km / h.

- BARRIERS/OBSTACLES

The main barriers was concern of traffic safety. The study shows that the concerns about the overall total negative effect of road safety on bicycle crossings and bicycle passages have not been confirmed. In the municipality Gävle, where there are most bicycle crossings in Sweden (more than 40), there is no overall increase in accidents on bicycle crossings or bicycle passages.

- LESSONS LEARNED

Changing law in favour to bicyclist is good for traffic safety if the change also stipulates that the traffic environment should be designed so it is not possible to drive vehicles at speeds higher than 30 km / h.

- CONTACT

[Mathias.warnhjem@trafikverket.se](mailto:Mathias.warnhjem@trafikverket.se)

[svante.berg@movea.se](mailto:svante.berg@movea.se)

- REFERENCES

- [1] Berg, S (2017) "Säkra Tillgängliga Cykelöverfarter". Pub 2017:213, Swedish Transport Administration.

## 6.1.2. Case studies dealing with VRU-oriented solutions

### 6.1.2.1. Kinematics of powered two-wheelers (PTW) at bends on intercity roads

#### ○ COUNTRY

France

#### ○ SUBJECT

In France, PTWs are largely concerned by road safety (18% of fatalities), especially on rural roads where mortality is high (66% of motorcyclists are killed on rural roads). On these roads, accidents at bends are common and with high gravity (41% of fatalities) and there are no specific information on how bikers drive in bends. In order to know the interactions of the bikes at bends, a study in naturalistic driving was carried out. Its main objectives are to produce knowledge about kinematics, dynamics and driver actions on the controls of its motorcycle in order to identify the zone of influence and the difficulty of crossing a bend mainly according to its radius of curvature. To do this, a diverse bikers panel drove an instrumented motorcycle on a rural road with multiple bends with different characteristics.

#### ○ PROJECT DESCRIPTION AND SUMMARY

The study focused on a panel of 18 motorcyclists. All of the participants were Cerema Normandie-Centre personnel, with the panel made up exclusively of men (no women were available to take part), each covering an average of around 3,000 km per year on a motorcycle. The riders were unaware of the purpose of the experiment and the only instruction they received was to drive naturally. Each rider travelled along the route once during off-peak times in order to limit disturbance from traffic and to have as many “free-moving” PTWs as possible.

The instrumented motorcycle (called MACC) is able to deliver the following informations:

- to gain a deeper understanding of the environment surrounding the motorcycle (cameras);
- to learn about PTW dynamics (Inertial Measurement Unit, or IMU);
- to measure trajectory and speed on a continuous basis (GPS);
- to monitor handlebar controls (data acquisition board).



*Figure 6.136 - The instrumented motorcycle (called MACC)*

The route between Rouen and Gournay-en-Bray in Normandy was chosen because it comprised a high number of bends on intercity roads (30 bends in each direction, i.e. 60 bends in total). The bends were categorised according to radius: small radius:  $< 150$  m, moderate radius:  $150 \text{ m} < R < 250$  m, large radius:  $> 250$  m.

Once all of the motorcyclists had travelled along the route, we collected the data and carried out three consecutive processing operations. First, we filtered the data to include “free” motorcyclists only (using camera footage). Next, we discarded all but the 90 km/h bends for consistency purposes (we have discriminated the limited turns at 70 and 50 km/h), leaving 25 of the original 60 bends. Finally, we broke down each bend into three sections: entrance, vertex and exit.

The data analysis was dedicated on speed, roll and trajectory especially according the bend direction (left-hand or right-hand bend) and the radius of the bend.

#### ○ KEY RESULTS/ACCOMPLISHMENTS

The use of an instrumented motorcycle with a panel of riders was to create a non-intrusive data collection system in order to analyse motorcyclist strategy, to learn about motorcycle practices under normal driving conditions, and to identify the behavioural and dynamic characteristics of the vehicle on open roads in order to improve PTW safety. Road design guides rarely consider PTW riders because there is insufficient qualitative and quantitative data. This study provides some of the missing elements, revealing how PTW speed and roll differ according to curve direction (right/left) and, to a greater degree, radius. Indeed, the study’s findings show that low-radius left-hand bends appear to be the most difficult to negotiate.



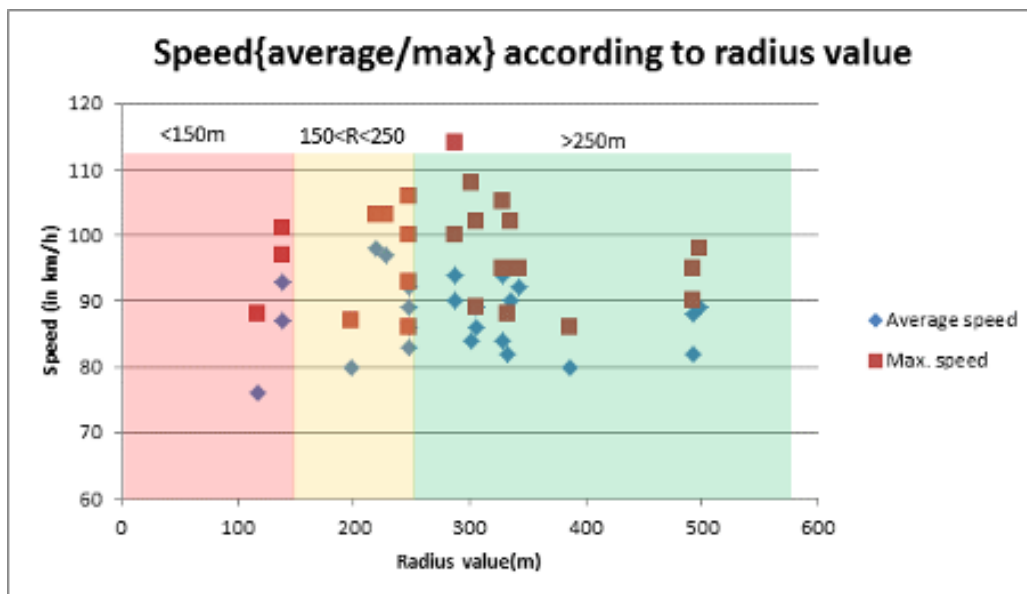

Graph 6.3 - Speed (average/max) un km/h according bend radius of curvature

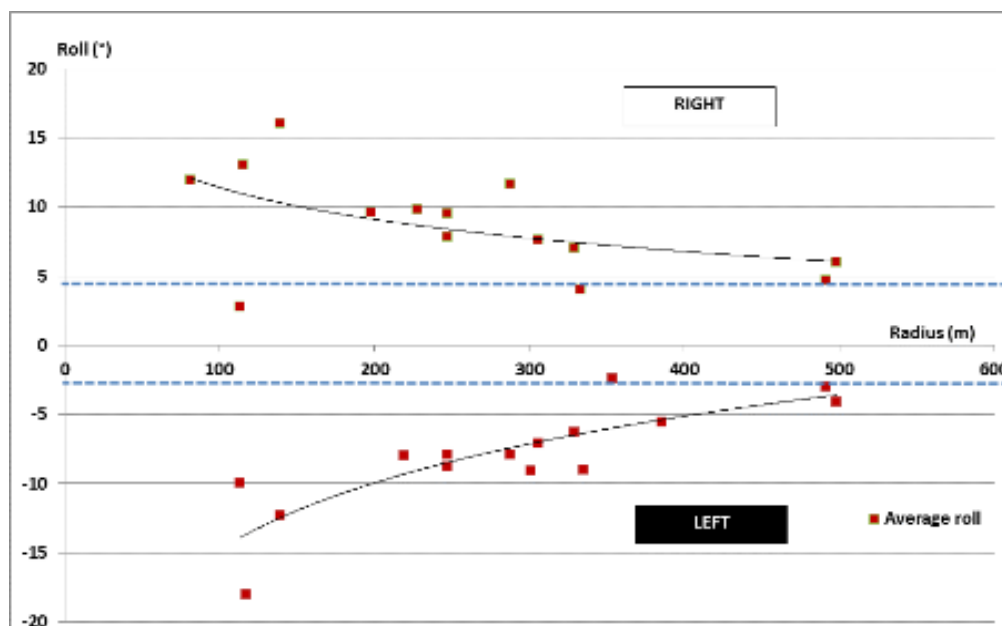

Graph 6.4 - Average roll at the vertex according to radius value

In terms of trajectories, the study compared bend types and categories and found that the formulae used to determine bend categories (based previously on the car database only) were consistent with results for PTWs and, therefore, that the formula can also apply to PTWs. However, this hypothesis will need to be tested with a statistical study. According to Spacek trajectory typology, the study showed the “ideal trajectory” is the most common with “swinging trajectory”.

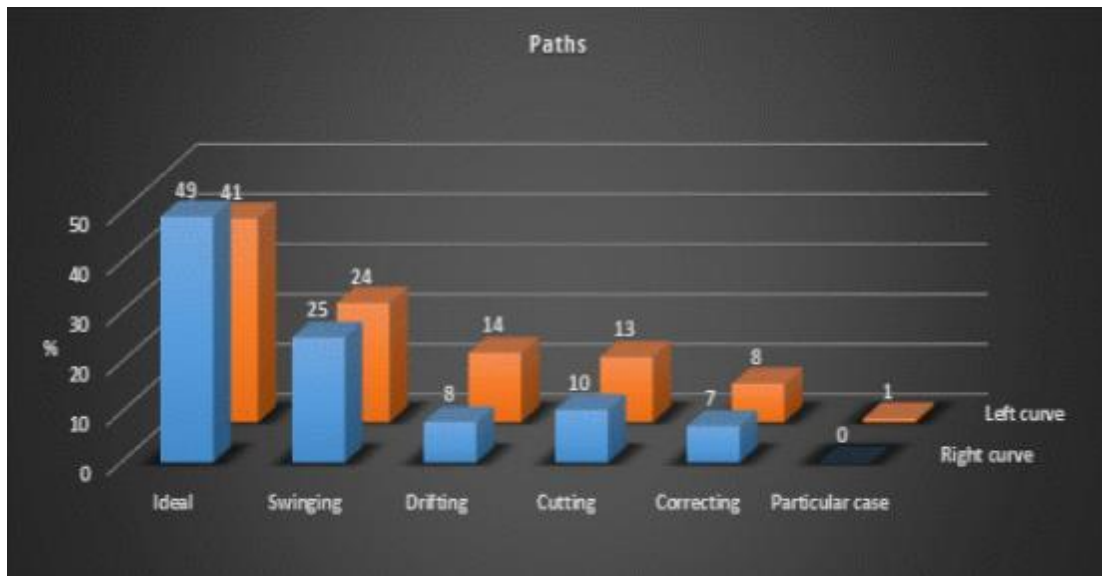

Graph 6.5 - PTW Trajectories according Spacek typology

○ CONTACTS

[peggy.subirats@cerema.fr](mailto:peggy.subirats@cerema.fr)

○ REFERENCES

- [1] Hublard, A., Subirats, P., Floris, O. Kinematics of powered two-wheelers at bends on intercity roads, Transport Research Arena TRA 2018, April 16-19, 2018, Vienna

### 6.1.2.2. Crosswalk removal

#### ○ COUNTRY

Italy

#### ○ IMPLEMENTATION ORGANIZATION

Municipality of Florence

#### ○ SUBJECT

The case study deals with the choice to remove a pedestrian crossing in order to encourage the use of a pedestrian underpass that is already near the crossing.

#### ○ PROJECT DESCRIPTION AND SUMMARY

The pedestrian crossing was located near a high school and in a very busy street near the center of Florence. The road where the crossing was placed has four lanes, three in one direction and it is bordered by trees. In the middle of the trees there are accesses and some parking lots.

Few meters from the crossing there is a pedestrian underpass through which it is possible to cross the road. The underpass also connects this area with the area placed on the north side of the railway.

The use of the pedestrian crossing on the surface is encouraged not only by the greater accessibility and by the apparent time required to cross the road using it rather than the underpass, but also by the presence of two bus stops at both sides of the 'crossing.

The user, immediately seeing the zebra crossing stripes, is instinctively pushed to use that crossing, rather than travel a longer stretch to take advantage of the underpass.

It should also be noted that the crossing didn't have any traffic lights and this is at the expense of pedestrian safety. Furthermore, often pedestrians found themselves hidden behind parked cars (it is difficult to control unauthorized stops, especially if they are carried out for short periods of time) or tried to cross when the traffic flow is blocked, exposing themselves to the risk of accidents involving two wheelers that are surpassing.

The aim of the intervention was therefore to completely remove the pedestrian crossing on the surface and reposition one of the bus stops so that it is closer to the entrance of the underpass.



Figure 6.137 – Pedestrian crossing before the intervention [2]

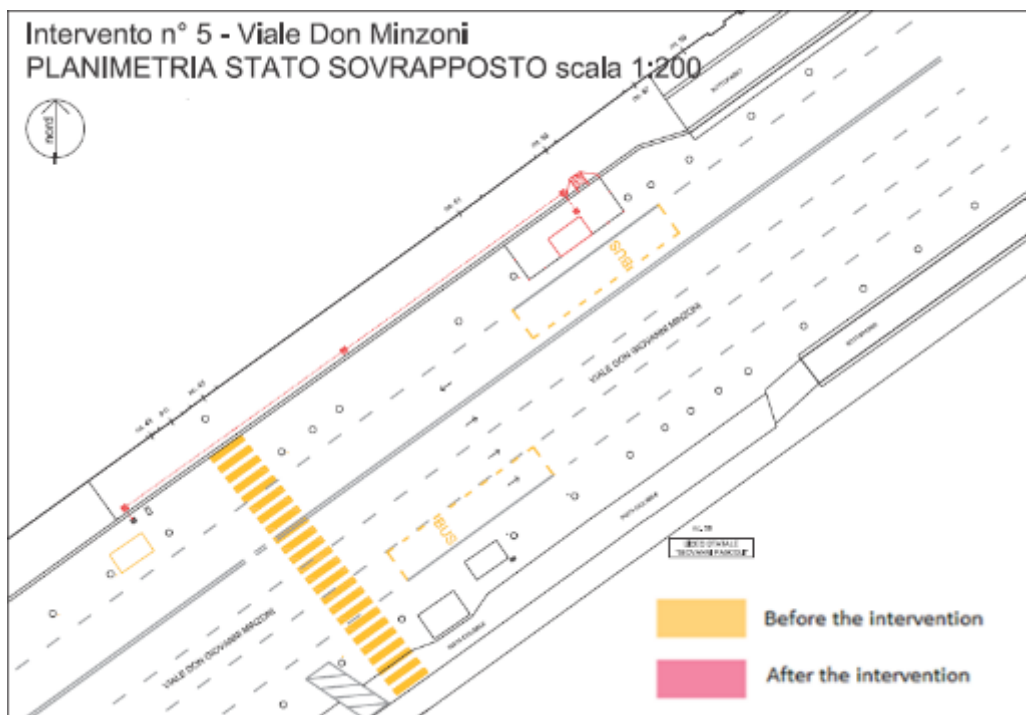

Figure 6.138 – Design scheme of the intervention [1]

#### ○ KEY RESULTS/ACCOMPLISHMENTS

Three years after the intervention there were no accidents. Pedestrians use the special underpass without risking crossing the road in the absence of stripes. The solution also appears functional, as it favours vehicular circulation.





Figure 6.139 – Pedestrian crossing before the intervention (removed) [2]

#### ○ POLICIES

The goal was to encourage the use of a pedestrian underpass already in the area of intervention (about 50 m from crossing). If able to choose, a pedestrian often opts to use the pedestrian crossing on the road: forcing the use of the underpass eliminating the superficial crossing can provoke discontent for the users of the area at first, but after a long time the use the subway will become habitual, encouraging not only an increase in road safety, but also a greater complicity of users in using pedestrian underpasses.

#### ○ BARRIERS/OBSTACLES

Very often pedestrian underpasses, as sometimes also elevated pedestrian crossings, are almost always a second choice if there is a pedestrian zebra crossing placed along the road. This is mainly due to the fact that crossing the road on the same floor is the shortest route in terms of space, and apparently shorter in terms of time (it can turn out to be the opposite having to wait for a right traffic time interval to cross). Making a crossing on a different level than the road may also be burdensome in terms of costs, but in the case of the intervention, an underpass was already present, so the choice of the Municipality of encouraging and almost obliging its use was a correct and not expensive choice.

#### ○ CONTACTS

[monica.meocci@unifi.it](mailto:monica.meocci@unifi.it)

[andrea.palioetto@unifi.it](mailto:andrea.palioetto@unifi.it)

#### ○ REFERENCES

[1] Comune di Firenze, delibere,

[http://www.comune.fi.it/export/sites/retcecivica/comune\\_firenze/comune/atti\\_e\\_delibere/ode\\_web\\_del.htm](http://www.comune.fi.it/export/sites/retcecivica/comune_firenze/comune/atti_e_delibere/ode_web_del.htm)

[2] Google Maps

### 6.1.2.3. Building wider and dedicated cycling paths to segregate pedestrians and cyclists

#### ○ COUNTRY

Singapore

#### ○ IMPLEMENTATION ORGANIZATION

Land Transport Authority

#### ○ SUBJECT

The case study describes efforts in Singapore to create more (dedicated where possible) space for safer interaction among the vulnerable road users like pedestrians, cyclists and personal mobility device users.

#### ○ PROJECT DESCRIPTION AND SUMMARY

More cyclists and personal mobility device users are seen travelling on footpaths and on the roads in Singapore recently. As we move towards car-lite from the motor centric society, when the active mobility population continues to increase, the chances of various conflicts among the vulnerable group users and as well as with the motorists is likely to increase perpetually. As such, since 2010, the authority chose to push forward off-road dedicated cycling paths where possible to demarcate space and to enhance safety and cohesiveness among all road users. Residents will be connected to major transport nodes and key amenities by the cycling path network. To-date, about 230km of cycling paths have been constructed, with a total of 700km to be implemented by 2030. The standards for a cycling path are 2 m dedicated wide which is typically alongside a 1.5 m footpath (intra town network) and 2.5 m + 1.5 m for inter town network. Where there are site constraints, generally sub-standards of 2.5m shared paths are used.



Figure 6.140 – The realized cycle path

#### ○ KEY RESULTS/ACCOMPLISHMENTS

A before after study conducted on 6 cycling towns (completed in 2013-2015) concluded that there is a significant increase in the uptake of cycling by previous non-cyclists in two towns and existing cyclists have also shown significant increase in cycling frequency in 2 towns. Survey counts have shown that the cycling path networks are well utilized by cyclists, have increased the frequency of cycling and have improved the safety perception of both cyclists and pedestrians.

A perception survey was also carried out to evaluate user perception of the cycling path implementation. The frequency of cycling and the likelihood to engage in commuting cycling is higher for males. There is a high tendency for older generation to cycle, especially for personal errands. Other than the likelihood to engage in recreational cycling, the younger generation consistently displays a low likelihood to cycle.

These results shed some positive lights in nudging mode share shift to active mobility. It helps validate the need of cycling infrastructure to achieve long term behavioural changes to adopt cycling and to improve overall comfort and safety level of both cyclists and other users.

#### ○ POLICIES

The Government introduced the Active Mobility Act in 2017 after a nationwide consultation, led by an advisory panel which comprised representatives from key stakeholder groups such as seniors, youths, cyclists and personal mobility device (PMD) users. The new Act introduces clear and practical rules that safeguard the safety of all users, and also balance various mobility needs. Cyclists and PMD users can now make use of footpaths islandwide to get around. This ensures that the more vulnerable users such as the elderly and the young do not have to use the roads to get around. With more users on the paths, safeguards such as speed limits and device criteria have been put in place to ensure the safety of everyone. Consistent guidelines for the public path system have also been established to manage public expectation and regulate good behaviour. Efforts will be made to harmonise across agencies and town councils on islandwide application.

#### ○ BARRIERS/OBSTACLES

In the land scarce country like Singapore, a well-balanced approach has to be taken to cater to the needs of all road users and various stakeholders. Mindsets of users have to be changed to embrace this active mobility mode.

#### ○ LESSONS LEARNED

Various stakeholders need to be actively engaged to come to a consensus of the typologies of the road side table.

#### ○ COSTS

\$700/m of cycling path excluding cost for relocation of existing infrastructure

#### ○ CONTACTS

[Koh\\_puay\\_ping@lta.gov.sg](mailto:Koh_puay_ping@lta.gov.sg)

#### 6.1.2.4. Construction of elevated pedestrian walkways or underpasses

○ COUNTRY

Spain

○ IMPLEMENTATION ORGANIZATION

General Road Directorate of Fomento Ministry

○ SUBJECT

The need for pedestrians to cross the road in areas close to urban sections carries a high risk of being run over. In urban areas, the speed calming measures that are usually used allow the use of pedestrian overpasses, or even at the same level if they are signed correctly and the available visibility is sufficient.

However, in sections close to urban areas, the provision of speed-calming measures is not easily understood by users. Normally the conditions of the environment of the road do not facilitate the perception that it is necessary to reduce the speed, so that the efficiency of the traffic signing of speed limit is reduced.

The current standards establish that under unfavorable conditions (area outside of town, absence of sidewalks or shelters, etc.) it is recommended to warn drivers of the proximity of a section with frequent pedestrian crossing by the corresponding regulatory road signing. The corresponding speed limitation must be added to the mentioned road signing, depending on the existing visibility, so that the safe stopping of a vehicle is possible. In any case, on roads with a maximum speed of over 60 km / h, the provision of a pedestrian crossing is only permitted if it is regulated by traffic lights.



*Figure 6.141 - P-20 Road Sign: Danger due to the proximity of a place frequented by pedestrians*

However, various studies of High Accident Concentration Sections identified in the State Road Network have shown cases in which numerous collisions with pedestrians were recorded, despite the provision of adequate signing or the existence of traffic lights.





*Figure 6.142 - Pedestrian crossing with traffic lights in an area near a town*

Therefore, road safety expertise analyzed the cases in which the solution could be the provision of a pedestrian crossing at a different level (overpass or underpass).

#### ○ PROJECT DESCRIPTION AND SUMMARY

The study of High Accident Concentration Sections that the General Directorate of Roads draws up periodically, analyzes those sections that present an accident risk significantly higher than the average recorded in the sections with similar characteristics.

The main objective of this study is to select places where by means of local actions, generally of low cost, significant reductions in the accident rate are achieved. But it is also searched that the systematic work in the analysis of the High Accident Concentration Sections will provide information for the development and improvement of design standards and road construction.

This information on sections where high accident rates are recorded allows us to evaluate the characteristics of the road or its equipment that are related to accidents. The process to improve them and their subsequent monitoring allows the establishment of solutions which are the most effective for the usual problems, being able to establish recommendations for the improvement of road safety.

This is the case of the usual crossing areas for pedestrians in areas outside the town, where it has been proven that the most effective solution to reduce the collisions with pedestrians is the construction of a crossing pass at a different level, with only level solutions valid if effective measures are adopted for the reduction of the speed and, if the maximum speed is high, arranging the passage protected by traffic lights.

Therefore, the alternative of building a pedestrian pass at different levels has been included among the most effective alternatives for the resolution of the high accident rate due to pedestrian overcrowding in areas outside the town. Although it is necessary a detailed study of the conditions of the section to evaluate the viability of the work, and analyze the establishment of other possible alternative solutions.

#### ○ KEY RESULTS/ACCOMPLISHMENTS

The main results obtained from the studies carried out have been the following:

- The installation of pedestrian crossings at the same level as the road outside populated areas can only be considered complemented by efficient speed calming measures. However, it must be ensured that such measures are credible for users. Otherwise, it would be safer the solution of a pedestrian crossing at a different level.
- In cases where it is not physically possible to build the pedestrian crossing at a different level, the most effective solutions are the provision of traffic lights (of fixed phases or pedestrian activated), with signing reinforcement approaching them. The temporary regulation by traffic agents is an alternative applicable only in special situations (for example, in the case of schools with very marked pedestrian peak times)
- The construction of pedestrian crossings at different levels should be considered as a joint treatment of pedestrian traffic in the road area affected. This involves a joint study for the layout of sidewalks and refuges. And where appropriate, they should be analyzed together with the arrangement of the elements that generate pedestrian traffic in the area, such as bus stops, parking areas, etc.



*Figure 6.143 - Example of pedestrian bridge in a population alternative*

- In general, the best solution is to create a clear and attractive pedestrian route that connects the pedestrian bridge or the underpass with the poles of attraction of the pedestrian movements. An effective measure is to complete them by physically preventing them from leaving the itinerary, installing pedestrian parapets or other elements that physically prevent them from leaving the authorized area.
- In the case of underpasses, personal safety problems may arise, which is why pedestrians are reluctant to use them. Therefore, they should be arranged preferably at points where there is a high pedestrian frequentation.

#### ○ POLICIES

The conclusions of the study have not resulted in new road safety policies. The conclusions of this kind of measures have been included in several publications and manuals. These conclusions have even been presented at road safety conferences. These studies are useful as reference for road

safety auditors or as solutions for specialists carrying out a high concentration accident section studies.

#### ○ BARRIERS/OBSTACLES

The main problems identified for the provision of pedestrian crossings at different levels are those listed below:

- Sometimes it is not physically possible to locate the footbridge, depending on the space available in the roadsides. In the case of underpasses, it is also necessary to consider the possible services existing under the road.
- In the underpasses it is necessary to evaluate in detail the conditions of drainage of the pass and of the underpass approach to it.
- In cases where pedestrians are not physically prevented from directly crossing the road, it has been observed that the use of the overpass or underpass is reduced. Pedestrians who continue to cross at road level normally do so because the time spent is less and pedestrians choose to do so if the perceived risk is small.

#### ○ LESSONS LEARNED

Pedestrians tend to make their way as short as possible, so in many cases the only effective way to make them use passes at different levels is to physically prevent them. The provision of pedestrian parapets on sidewalks or fences on the roadsides and road medians are the most appropriate measures to force the use of overpasses and underpasses.



*Figure 6.144 - Example of fence over New Jersey barrier, to avoid pedestrian crossing in an area with overpass*

In the case that the characteristics of the roadsides prevent the construction of an overpass, the solution of doing it at the same level must be accompanied by effective measures traffic speed calming. The arrangement of pedestrian crossings regulated by traffic lights is shown as the safest alternative.

In any of the solutions chosen, it must be taken into account its use by people with reduced mobility, so it will be a crucial factor in all cases, and especially with space limitations.

○ COSTS

Pedestrian overpasses: 150.000-1.000.000 €/ud (for roads of 10 m width, depending on the conditions of the area and the material used)

Underpasses: 200.000-600.000 €/ud (for roads with 10 m width)

○ CONTACTS

Roberto Llamas Rubio [rlamas@fomento.es](mailto:rlamas@fomento.es)



### 6.1.2.5. Protected Cycling Routes

#### ○ COUNTRY

Spain

#### ○ IMPLEMENTATION ORGANIZATION

Dirección General de Tráfico (DGT)

#### ○ SUBJECT

The main topic addressed is VRU along road section, in particular, the implementation of protection measures for cyclists on inter-urban journeys during peak periods, involving the rest of the road users, encouraging coexistence on the same roadway among different types of vehicles, including cyclists (vulnerable users).

#### ○ PROJECT DESCRIPTION AND SUMMARY

The main objective of the project is to make the road a safe place for all users, including the vulnerable. The following steps that have been taken to achieve this objective:

- Selection of protected cycling routes in collaboration with other administrations, institutions and cycling associations. A total of 3 routes have been selected for each province, with a total of 138 routes covering 4,661 kilometers.
- Implementation of specific measures to protect these routes during the days and hours of the most important and usual presence of cyclists, which is usually on Saturday and Sunday mornings. The measurement catalog that can be run for each route:
- Signposting of the cycling route and traffic calming: temporary reduction of the maximum speed limit.
- Reinforcement of surveillance to ensure compliance with safety rules regarding overtaking lateral distance to cyclists, inappropriate speeding or non-regulatory manoeuvres.
- Complementary surveillance using airborne resources (Helicopter).
- Preventive controls of alcohol and other drugs on these selected routes, as well as on their access routes.
- Specific road maintenance actions such as roadside and shoulder cleaning.

#### ○ KEY RESULTS/ACCOMPLISHMENTS

Given the recent implementation of the measure, it is too early to establish a full assessment of the measure, although it has been developed in two main ways:

- Greater use of protected cycling routes by bicycle users as they are signposted, publicized, and specific tasks are carried out during the periods of greatest cycling traffic.
- Possibility of impact on accident data, requiring in-depth assessment

#### ○ POLICIES

The measure has been accompanied by the following policies:

- Decrease of the existing speed limit on the road temporarily and during periods of increased traffic intensity of cyclists to reduce the differences in speed between vulnerable road users and other road users.
- Reinforcement in the communication to road users of the need to maintain a safety margin of 1.5 metres when overtaking cyclists in accordance with current regulations.
- Awareness campaign for cyclists on the respect of traffic regulations.
- Collaboration among different administrations to achieve a common objective

#### ○ BARRIERS/OBSTACLES

- Need for coordination between different administrations as there are different competences involved in the implementation of the measure.
- Heterogeneity of the routes where it has been applied.
- Need to implement a major diffusion campaign to achieve the objectives set during the start-up period.

#### ○ LESSONS LEARNED

Low-cost measures can be put in place to significantly increase road safety for vulnerable road users and other road users by exploiting existing infrastructure.

#### ○ COSTS

The intervention does not require significant costs as:

- Installation of signing on application roads (Low cost).
- Reinforcement of maintenance and conservation tasks (programming in the periods prior to their use).
- Strengthening and increasing the monitoring and control of traffic discipline.
- Publication of the information, through the use of own resources.

#### ○ CONTACT

Antonio Granado – [agranado@dgt.es](mailto:agranado@dgt.es)



Figure 6.145 – Road sign of protected cycle route example 1



Figure 6.146 – Road sign of protected cycle route example 2



Figure 6.147 - Location map of Protected Cycling Routes

○ REFERENCES

- [1] <http://www.dgt.es/es/el-traffic/rutas-ciclistas-seguras/>
- [2] <http://revista.dgt.es/es/noticias/nacional/2017/07JULIO/0727-Rutas-ciclistas-protégidas.shtml>

### **6.1.2.6. Segregated cycle paths from the main travelled way**

#### ○ COUNTRY

Spain

#### ○ IMPLEMENTATION ORGANIZATION

General Road Directorate of Fomento Ministry

#### ○ SUBJECT

The increase in the use of bicycles, has led to a significant increase in road accidents involving this kind of vehicles. Most of these accidents, in which cyclists are involved, occur in urban areas, although they have less severity than those occurred in interurban areas where the speed of other vehicles sharing the road with them, is higher.

For this reason, the General Road Directorate of Fomento Ministry has carried out an analysis of accident rates involving cyclists in the Spanish Road Network, because the social impact of these accidents and their severe consequences.

The aim of this study has been, from the basis of the knowledge and description of accident rates involving cyclists, to draw up a guide of good practices of application to the Spanish Road Network, including measures to reduce cyclist accident rates. Some of the conclusions have been collected in the recent updated Standard of Road Design.

#### ○ PROJECT DESCRIPTION AND SUMMARY

First of all it was analyzed cyclist accident rates in the Spanish Road Network, with data from a period of five complete calendar years. There were analyzed 1.110 cyclist injury accidents, from which 43 resulted as fatal accidents with 44 fatal victims and 212 serious injuries. 473 of these accidents occurred in junctions, with 15 fatal victims in them.

The main results obtained were:

- 3 out of 4 cyclist accidents occurred while driving on interurban conventional roads.
- 40% of these accidents were collisions with other vehicles
- 2 out of 3 accidents occur between April and September, with more favorable weather
- 1 out of 3 accidents occur on weekends (Saturdays and Sundays)



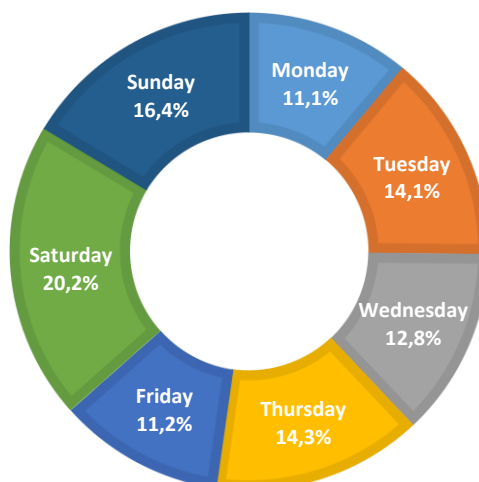

Figure 6.148 - Cyclist injury accidents distributed per day of the week in the Spanish Road Network

Subsequently, the designs and measures applied in different countries were evaluated to identify the safest designs and could be applied to reduce the incidence of the above factors. Among those that affect the road, the following stand out:

- Ease with which cyclists' access the requested destinations. It must be taken into account that accessibility can be achieved with bicycle paths combined with public transport
- The set of bicycle paths and their different connections must be established to be a real alternative. If the time invested was excessive it would be discouraging the use of the bicycle or taking its use to other itineraries
- The bicycle paths, in addition to being comfortable and safe, should be sufficiently attractive, so that in its design, aspects such as road signing and marking, drainage, rest areas, lighting and environmental aspects, among others, must be taken care of.

#### ○ KEY RESULTS/ACCOMPLISHMENTS

The main result of the study has been the identification of the best solutions for a safe cyclist traffic, obtained from the accident data and the real cases analyzed. The desirable characteristics and the types of roads that comply with them have been identified too.

Bicycle paths can be exclusive, segregated from other users, or shared with some of them (cars, pedestrians, etc.), and be one-way paths or bidirectional paths. However, in all cases, actions on infrastructure are focused on speed, which is crucial for accidents to occur and, above all, on their consequences. Therefore, to increase the safety of cyclists, work must be done to achieve:

- Reduce the number of encounters between cyclists and other vehicles, and improve harmony between cyclists and fast motorized traffic
- Reduce speed differences where separation between bicycles and motorized vehicles is impossible to avoid

In the carried out study, the obtained result has been that the greatest safety is reached when the flows of the different types of vehicles are separated, together with the lowest possible number of junctions between them. It is also important to achieve the greatest homogeneity of traffic

conditions and resolution of the decision-making points, providing cycling itineraries with the best possible "readability".

Consequently, the considered solution to be the safest is the so-called "Pista-bici", which is a one-way or bidirectional cyclist path, segregated from motorized and pedestrian traffic, and with an independent alignment and roadbed. In case of urban areas, the safety of cyclists improves by establishing speed limits at 30 km/h, through the construction of cycle paths, the creation of streets with traffic calming systems, the increase in the distances of the bicycle paths, or the conditioning of special lanes for bicycles that facilitate faster crossings and turns, etc. In general, it is very difficult to segregate the traffic of cyclists from the rest of the users, so that other kind of solutions are adopted:

- Bicycle-sidewalk: One-way or bidirectional bicycling path, arranged on the sidewalk, which can have different degrees of differentiation and protection with respect to pedestrian mobility.
- Protected bicycle paths: Cyclist path that occupies part of the roadway and that is separated physically from it and from motorized traffic, as well as from the sidewalk, through lateral elements such as bollards, curbs or other elements of separation or protection.

#### ○ POLICIES

Standard 3.1-IC Alignment, of the Highway Instruction, approved by Order FOM / 273/2016, of February 19, establishes in section 8.15 a series of criteria for bicycle lanes adjacent to roads. This section establishes textually:

"The bicycle path design is not subject to this Standard. However, given that there may be important interactions between these bicycle paths and the roads, usually designed and executed by different organisms, the basic conditions of coordination between both are defined in this section. The conditions to be considered relating to junctions of bicycle paths and roads are included in section 10.5.4.

Bicycle path is defined as the road specifically conditioned for cycle traffic, with the corresponding traffic signing and road marking and with a width that allows these vehicles pass. The bicycle path will not be considered as a road.

In the interurban road sections, any bicycle path that runs parallel or next to said road must be segregated from it. A cycle track will be used, which is the cyclist path segregated from motorized traffic, with an alignment which is independent of the road



Figure 6.149 - Source: Recommendations of bicycle paths of the General Road Directorate of the Public Works, Urban Planning and Transport Department of the Community of Madrid. August 2001

If it is not possible to segregate the bicycle paths by using the cycle track, these paths can be attached to the roadway, with the following conditions:

- In a periurban and urban section of any kind of road, a protected bike lane will be designed, which is the bicycle path with lateral elements that physically separate it from the road platform. The lateral strip that, acting as a berm, serves as a physical separation between the road platform and the protected bike lane will have a width over or equal to one meter and fifty centimeters ( $\geq 1.50$  m).
- In urban sections of conventional and multi-lane roads with project speed ( $V_p$ ) under or equal to fifty kilometers per hour ( $\leq 50$  km / h) and, if it is not possible to install the protected bike lane, exceptionally and with due justification can be designed a bike lane, which is the bicycle path that runs attached to the platform of the road. The minimum width of separation between the platform of the road and the bike lane will be one meter ( $\geq 1.00$  m).

In addition to the vehicle containment system, the protected bicycle path will have, at least, an enclosure located between the road and the bicycle path.

In any case the execution of a bicycle path attached to the road will mean the reduction of the shoulder width of the road.

Cyclist paths will not be located occupying road shoulders”.

Regarding to the junctions between the cycle tracks and the roads of the state network, section 10.5.4 establishes the following:

The bicycle paths cannot have junctions with toll roads, highways, or with their interchanges or collectors. Neither may they intersect with multi-lane roads (except at junctions regulated by traffic lights). At junctions with rural roads the bicycle paths will not have priority of passage.

In their design, the following conditions must be considered:

- Existence of reciprocal stopping and crossing sights
- Minimum itinerary of cyclists in the horizontal alignment of junctions.

- Disposición, en su caso, de refugios de espera con una longitud mayor o igual que dos metros ( $\geq 2,00$  m).
- Arrangement, where appropriate, of waiting refuges with a length greater than or equal to two meters ( $\geq 2.00$  m).
- Specific road signing
- Differentiated pavement of the bicycle path in the surroundings of the junction

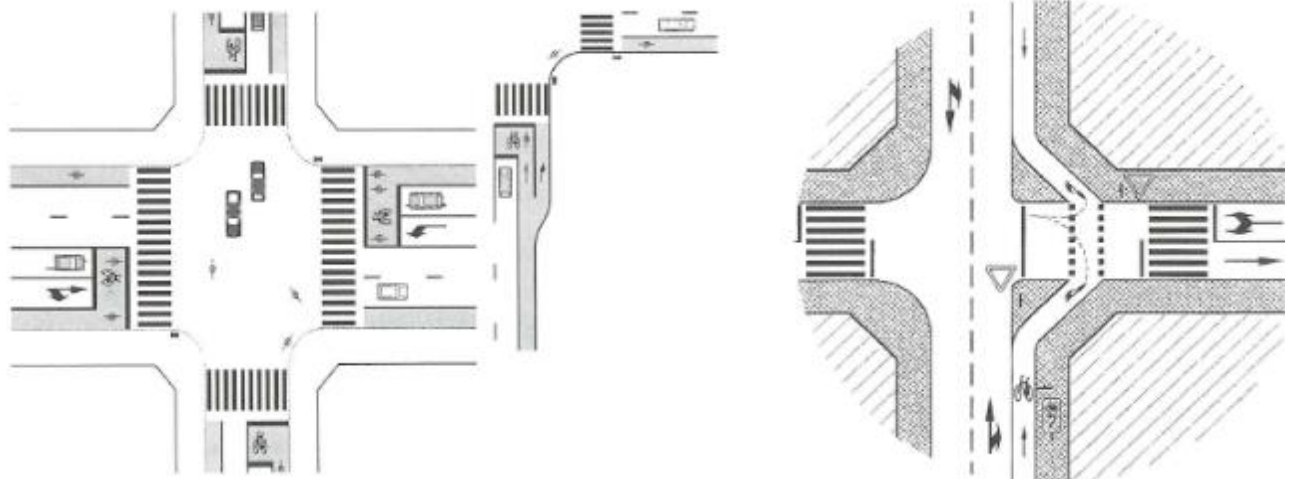

Figure 6.150 - Source: "The bicycle in the City". Fomento Ministry

In any case, it will be necessary to carry out a study of each junction that contemplates the main variables (type of junction, type of bicycle path, environmental conditions, etc.) and design the solution that optimizes the indicated criteria.

#### ○ BARRIERS/OBSTACLES

It is accepted that a global network of bicycle paths is the basis of any subsequent design. Therefore, proper planning is what allows concrete solutions and designs to be adequate, allowing a comfortable and safe transit, and thus encouraging the use of bicycles.

In Spain there is no general planning document for cycling paths, although different road administrations have developed plans in the network of their ownership, including some manuals such as Design Recommendations for cycling routes in Andalusia or Foral Regulation 4/2010 of the Cyclist Routes of the Historical Territory of Álava.

Therefore, it is necessary an effort of coordination and integration of the different existing plans, so that in the medium term a programming of the actions of implementation of cycling paths can be prepared, being able to complete a global national network, optimizing the existing one and completing the sections with greater demand.

Cyclists also need facilities to park their bicycles safely, easily and orderly. This requirement is more important than it may seem, since when considering the risk of theft or damage to a bicycle it is seen as an important disincentive factor. Therefore, this circumstance should not be forgotten during planning, which is not always the case.



#### ○ LESSONS LEARNED

Despite having established general design conditions for cycle paths, the Ministry of Public Works does not have a Design Manual for cycling paths, where their characteristics (turning radius, width, gradient, etc.) are established.

Therefore, it is considered necessary to go deeper into this line of work and take the necessary steps to have a reference document for the design and construction of bike paths in the sections of the national road network.

It is also advisable to advance in the homogenisation of signing and defense elements of the bicycle paths from different ownership.



*Figure 6.151 - Example of differentiated coloured pavement and specific road marking in a bicycle path*

#### ○ COSTS

One-way bicycle path: 80,000 €/km

Bidirectional bicycle: 12,000-160,000 €/km

#### ○ CONTACTS

Roberto Llamas Rubio [rllamas@fomento.es](mailto:rllamas@fomento.es)

#### ○ REFERENCES

- [1] [https://www.fomento.gob.es/NR/rdonlyres/7CDCD3E7-850A-4A9C-813D-B87FAEDE1A7A/136019/Norma\\_31IC\\_Trazado\\_ORDEN\\_FOM\\_273\\_2016.pdf](https://www.fomento.gob.es/NR/rdonlyres/7CDCD3E7-850A-4A9C-813D-B87FAEDE1A7A/136019/Norma_31IC_Trazado_ORDEN_FOM_273_2016.pdf)

### 6.1.2.7. Evaluation of sweep-salting – a method for winter maintenance of bicycle paths

#### ○ COUNTRY

Sweden

#### ○ IMPLEMENTATION ORGANIZATION

Swedish Transport Administration and Swedish communities

#### ○ SUBJECT

Use of salt (NaCl) for de-icing and power brooms for snow clearance on bicycle paths to maintain a high degree of safe mobility for cyclists during winter.

#### ○ PROJECT DESCRIPTION AND SUMMARY

Using salt for skid control of bicycle paths could be one way to maintain a high degree of safe mobility for cyclists during winter. In recent years, a method using a front-mounted power broom for snow clearance and salt for de-icing (commonly called “sweep-salting”) has become popular for winter maintenance of bicycle paths in Sweden (). Linköping was the first municipality in Sweden to test the method, already in 1999, within a PhD-project conducted at VTI (Bergström, 2002). The promising results from the tests in the PhD-project encouraged Linköping to increase the use of the method, and they have been applying it increasingly ever since on selected bicycle routes in the municipality. In 2013 the city of Stockholm decided to improve their winter maintenance service level on bicycle paths, in order to promote cycling during winter. Therefore, Stockholm decided to try the “sweep-salting” method and evaluate its potential to improve the service level on bicycle routes for commuting (Niska & Blomqvist, 2016a; 2016b, 2018; Niska, Blomqvist & Järllskog, 2016; 2017). As Stockholm found interest in the method, so did several other municipalities and now (2018), at least 25 other Swedish municipalities have started to practice the method.



Figure 6.152 - A sweep sweep-salting measure on a bicycle path in Stockholm

#### ○ KEY RESULTS/ACCOMPLISHMENTS

The evaluations performed show that when working successfully, the sweep-salting method creates a bare surface with higher friction than traditional ploughing and gritting. Measures must

be done in time and the operating speed adjusted according to the prevailing conditions. In mild weather brine is sufficient, but with lower temperatures and heavy snowfall larger amounts of salt is needed and pre-wetted or dry salt must be used. For the method to work properly, the bicycle path construction should be of good condition without cracks or other damages in the surface.

In addition, the equipment for sweep-salting needs to be further developed for a more proper and efficient use on bicycle paths. For example, it would be beneficial with a new type of salt-spreader combining nozzles to spread brine, when that is sufficient, with a spinner to be able to spread pre-wetted or dry salt, when needed. A more optimal design and construction of snow sweeper brushes for the use on bicycle paths would also be valuable.

#### ○ BARRIERS/OBSTACLES

The sweep-salting method provides a higher winter maintenance service level than traditional ploughing and gritting. A high winter maintenance service level could encourage more people to cycle during winter – with environmental and health benefits as a result. It is also important considering the safety of cyclists. According to accident analysis, eight out of ten bicycle crashes in Sweden are single bicycle crashes and the most common cause in wintertime is slipperiness caused by ice or snow (Niska & Eriksson, 2013). In the springtime, a common accident cause is slipperiness due to grit from winter maintenance.

#### ○ LESSONS LEARNED

From the field studies performed and the experiences gathered so far, we would like to give the following recommendations when applying the sweep-salting method:

- Sweep-salting measures must be done in time, preferable before or at the very beginning of a snowfall. That demands high quality weather forecasts and a good knowledge about variations in local climate. Road temperature sensors and other local weather information systems would be beneficial.
- The operating speed must be adjusted according to the prevailing conditions.
- In mild weather with moderate amounts of snow brine is sufficient, but with lower temperatures and/or heavy snow-fall larger amounts of salt is needed and pre-wetted or dry salt must be used.
- When spreading brine, a spreader using nozzles will give a more even distribution of the salt, but a spinner is needed when spreading pre-wetted or dry salt.
- For the method to work properly it is important that the bicycle path construction is of good condition without cracks and other damages in the surface.

In conclusion, the sweep-salting method is a good solution for increasing a safe mobility for bicyclist and pedestrians. If optimizing “sweep-salting” to its full potential, applying the method could encourage more people to cycle – with environmental and health benefits as an outcome – and at the same time reduce the amount of single bicycle crashes during winter. However, to be able to give recommendations regarding the optimal methods, equipment and strategies when applying the method under different conditions and circumstances, further studies are needed to expand the knowledge of the processes involved in the system of salt and water on bicycle paths.

#### ○ CONTACTS

Dr. Anna Niska at the Swedish Road and Transport Research Institute, [anna.niska@vti.se](mailto:anna.niska@vti.se)

## ○ REFERENCES

- [2] Bergström, A. (2002). Winter maintenance and cycleways. *Doctoral thesis, TRITA-VT FR 02:04*, Avdelningen för Vägteknik, Institutionen för byggvetenskap, Kungliga tekniska högskolan. Stockholm.
- [3] Bergström, A. (2003). More Effective Winter Maintenance Method for Cycleways. *Transportation Research Record: Journal of the Transportation Research Board, No. 1824*, Highway Maintenance Safety, Support, and Services, Maintenance, Paper No. 03-2061. Transportation Research Board. Washington.
- [4] Blomqvist, G., Lindström, B., Järllskog, I., Karlsson, E. & Niska, A. (2016). Anti- and de-icing of walking and cycle paths – Field trials of new follow-up techniques for quantifying salt amount and resulting ice quality. The 8th International Conference of Snow Engineering, June 14–17, Nantes, France.
- [5] Blomqvist, G., Niska, A. & Järllskog, I. (2018). Follow-up methods for evaluation of winter maintenance of bicycle paths, including monitoring of bicycle-path-specific processes. Accepted for presentation at PIARC XV<sup>th</sup> International Winter Road Congress, Gdansk, 20-23 February 2018.
- [6] Jansson, J., Kok, S., Niska, A. & Blomqvist, G. (2015). Improved winter maintenance of biking lanes – is it a risk for urban environment?, 12th Urban Environment Symposium, June 1–3, 2015, Oslo, Norway.
- [7] Niska, A. & Blomqvist, G. (2018). Sweep-salting – A method for winter maintenance of bicycle paths. Accepted for presentation at PIARC XV<sup>th</sup> International Winter Road Congress, Gdansk, 20-23 February 2018. Paper No. 107.
- [8] Niska, A., Blomqvist, G. & Järllskog, I. (2017). Evaluating sweep-salting on bicycle routes in Stockholm in the winter of 2016/17. *VTI note 30-2017*, Swedish National Road and Transport Research Institute. Linköping.
- [9] Niska, A., Blomqvist, G. & Järllskog, I. (2016). Evaluating sweep-salting in Stockholm in the winter of 2015/16. *VTI PM 2016-12-01* (ID: 2013/0390-9.1), Swedish National Road and Transport Research Institute. Linköping.
- [10] Niska, A. & Blomqvist, G. (2016). Sweep-salting of bicycle paths. Evaluation of trials in Stockholm in the winter 2013/14. *VTI note 28-2015*, Swedish National Road and Transport Research Institute. Linköping.
- [11] Niska, A. och Blomqvist, G. (2016). Sweep-salting of bicycle paths. Evaluation of trials in Stockholm in the winter 2014/15. *VTI note 29-2015*, Swedish National Road and Transport Research Institute. Linköping.
- [12] Niska, A. & Blomqvist, G. (2015). Niska, A. och Blomqvist, G. (2015). Sweep-salting in Karlstad. Challenges and possibilities. *VTI note 25-2015*, Swedish National Road and Transport Research Institute. Linköping.
- [13] Niska, A. & Eriksson, J. (2013). Cycling accident statistics. Background information to the common policy strategy for safe cycling [in Swedish]. *VTI report 801*, Swedish National Road and Transport Research Institute. Linköping.



### 6.1.2.8. Warm wetted sand for skid control of walkways and bike paths

#### ○ COUNTRY

Sweden

#### ○ IMPLEMENTATION ORGANIZATION

Swedish Transport Administration and Swedish communities

#### ○ SUBJECT

Warm wetted sand for skid control of walkways and bike paths. Benefits and drawbacks of the method evaluated in Umeå

#### ○ PROJECT DESCRIPTION AND SUMMARY

Considering the safety of cyclists and pedestrians the winter maintenance service level needs to be improved and there is a need for skid control measures that are effective and, at the same time, reduce the amount of grit spread during the wintertime. Warm wetted sand, a method where the sanding material is mixed with hot water while spreading and where the sand adheres to a cold surface through a process of melting and freezing, could be the solution. In this study, the applicability of using warm wetted sand on walkways and bike paths has been evaluated in Umeå municipality during the winters of 2010/11 and 2011/12. The evaluations comprised measurements of friction, road condition observation and interviews with operators as well as cyclists and pedestrians.



Figure 6.153 - The equipment used for spreading warm wetted sand on walkways and bike paths in Umeå municipality, in Sweden.

#### ○ KEY RESULTS/ACCOMPLISHMENTS

Comparing measurements of friction clearly showed higher levels of friction improvements and with a longer duration when using warm wetted sand for skid control on walkways and bike paths compared to traditional dry sand. The study also showed that the number of actions can be reduced when using warm wetted sand instead of traditional dry, and it is therefore possible to reduce the amount of grit spread. The method was most effective on sections with on-street-cycling where the

road condition more often is thick ice. The apprehension that the method might create an uneven surface uncomfortable for cyclists was not perceived. The maintenance operators had, on the other hand, noticed that when spreading warm wetted sand on soft packed snow an uneven surface might occur, if the warm sand melts through the top layer of the snow surface. The main problem with the method is the freezing of the sand material in the hopper and the spreader, due to the high amount of fine graded particles in the sand mixture. The results are not promising enough to motivate an investment in equipment for skid control on walkways and bike paths only, but with a multi-purpose use it gets more cost effective.

#### ○ BARRIERS/OBSTACLES

On sections with on-street-cycling where a road condition of thick ice might occur, the method using warm wetted sand gives a better and more long-lasting effect than traditional sanding.

#### ○ LESSONS LEARNED

The idea of using warm wetted sand is a possible solution for increasing a safe mobility for bicyclist and pedestrians in cold regions with long periods of low temperatures. However, there are needs for development regarding of finding the best equipment and how to use this concept for obtaining the best cost effectiveness. The results were not promising enough to motivate an investment in equipment for skid control on walkways and bike paths only, but with a multi-purpose use it gets more cost effective. The high amount of fine graded particles in the sand mixture might create problems with freezing of the sand material in the hopper and the spreader. It is possible that the fine graded material might contribute to inhalable particles (PM10). More investigation is needed before recommending a more extensive use of the method.

#### ○ CONTACTS

Dr. Anna Niska at the Swedish Road and Transport Research Institute, [anna.niska@vti.se](mailto:anna.niska@vti.se)

#### ○ REFERENCES

[1] Niska, A. (2012). Potential of Using Warm Wetted Sand for Skid Control on Walkways and Bike Paths (WM-STW 12-108). TRB's Transportation Research Circular E-C162: Winter Maintenance and Surface Transportation Weather. April 30 - May 3, 2012. pp 117-124.

[2] Niska, A. (2013). Varmsandning på gång- och cykelvägar. Utvärdering i Umeå av för- och nackdelar med metoden. VTI rapport 796 (in Swedish), Statens väg- och transportforskningsinstitut. Linköping.

[https://www.vti.se/sv/Publikationer/Publikation/varmsandning-pa-gang--och-cykelvagar\\_667301](https://www.vti.se/sv/Publikationer/Publikation/varmsandning-pa-gang--och-cykelvagar_667301)

## 6.2. HUMAN FACTORS CASE STUDIES

### 6.2.1. Case Studies dealing with the Optical Guidance Rule of the Human Factors principles

#### 6.2.1.1. Experimentation of a modification of the signalisation layout by Flashing directional arrows (FLR)

○ COUNTRY

France

○ IMPLEMENTATION ORGANIZATION

Motorway Companies

○ SUBJECT

The subject covered by this experiment is the improvement of safety in the construction site approach, in particular the reduction of collisions with Flashing directional arrows in the right lane by heavy goods vehicles.

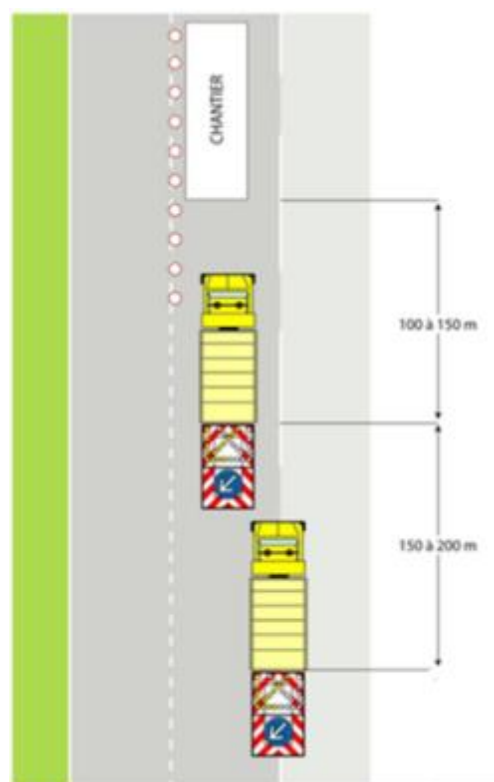

Figure 6.154 – Displacement of flashing arrows

The regulatory scheme for tagging with is as follows:

- Position the warning Flashing directional arrow on the emergency stop band (BAU) / right lane.
- Distance between the warning Flashing directional arrow and the position Flashing directional arrow: 150 m

The problems encountered by this device are as follows:

- Sensitive to heavy goods traffic: the warning device is the one most often affected
- Heavy goods vehicles often travel in trains, with reduced safety distances. Lane departure can therefore be late and abrupt, inducing a risk of shock with the encountered device.

#### ○ PROJECT DESCRIPTION AND SUMMARY

A study on practices in other European countries has been carried out. It highlighted a wide use of pre-signaling devices on emergency lanes, in particular with KD10 lane narrowing signs (KD10) and speed prescription signs (B14).

On this basis, the Motorway Companies requested authorization to test, on the conceded network, a new signaling device by Flashing directional arrow to replace the existing one.

The purpose of this new device is the improvement of safety when approaching sites, especially the reduction of Flashing directional arrow collisions in the right lane by heavy goods vehicles. The expected impacts are, in particular, a better anticipation of all the drivers to change lanes, a reduction in risk situations (i.e. masking of Arrow Flashing Lights by heavy goods vehicles) and a reduction in speed practiced by drivers. All this without exposing more staff, and with reducing the risks for drivers.

The experiment of a duration of 3 years, authorized and framed by 2 decrees dated 21.03.2016 and 09.08.2017, consists in (1) positioning the warning device on the emergency lane, (2) equip it with signs of KD10 / B14 or KD10 / AK5 type and (3) increase the distance with the position Flashing directional arrow (400m).

This new device in particular consists in:

- Pre-signaling upstream lane neutralization;
- A speed limitation display that previously did not exist in the KD10 / B14 configuration.

The expected gains from this experiment are as follows:

- Anticipated overtakes thanks to the KD10 sign;
- Trailer entirely positioned on the emergency lane therefore less vulnerable;
- First trailer less masked;
- Lower speed and speeding easy to report in the configuration with the B14 sign.



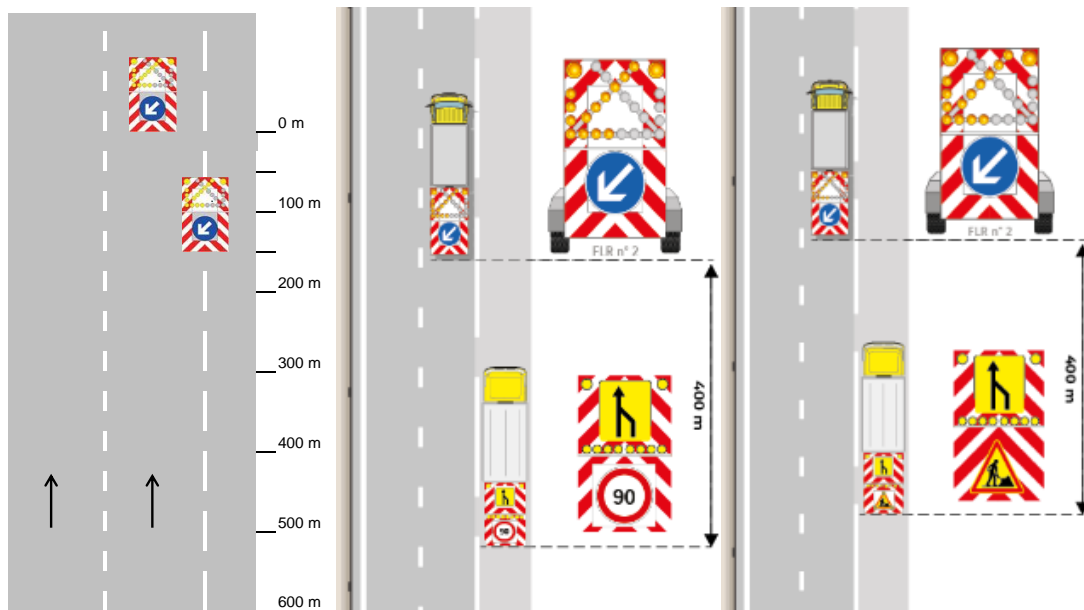

Figure 6.155 – Left: usual configuration, Centre and Right: experimental configuration with KD10 / B14 or KD10 / AK5 signs

#### ○ KEY RESULTS / ACCOMPLISHMENTS

ASFA (Association of French Motorway Companies) asked Cerema Normandie Centre (a technical center belonging to the ministry in charge of transport) to evaluate the new signaling configuration by Flashing directional arrow on vehicle trajectories: lane departure distances, actual speeds, inappropriate behaviour, incidents, etc.

Observations were made on four motorway sites. The context is a road work site during the day with neutralization of the right lane. At each site, the experimental configuration was compared to the usual configuration (2 hours of observation for each configuration).

The experimental conditions were as follows:

- The observation site is in right alignment and has no specificity in terms of layout and equipment. Visibility is greater than 1 km.
- Maximum authorized speed on the site is 130 km / h.
- Weather is dry.
- Traffic is similar in both observation phases at the four sites.

The means of observation were as follows:

- Video cameras located on an overpass above the position Flashing directional arrow and filming the trajectories of vehicles approaching the signage.
- Radar-counter on road side measuring the traffic and the actual speeds of the users at the position Arrow Flashing Light, discriminating light vehicles and heavy goods vehicles.

The main conclusions of this evaluation are as follows:

- Increase of the distance at which approaching drivers change lanes, especially for heavy goods vehicles.
- Decrease of light vehicle speeds when the pre-signaling is equipped with the B14 sign (on average 7 to 10 km / h).

#### ○ POLICIES

This experiment is currently underway on the network of several Motorway Companies. The aim is to request a change in the regulations on the use of Arrow Flashing Lights.

#### ○ BARRIERS / OBSTACLES

This experiment was initially authorized by decree dated 21.03.2018 for a period of 3 years on four motorways. This therefore limited the number of tests of this new device.

Moreover, in the case of the KD10 / B14 device, the regulations in force require the installation of an end-of-prescription sign (B31) at the end of the road work site. The installation of this sign results in additional exposure of the workers and imposes material means which annihilate the benefit of using the KD10 / B14 device.

Thus, the Highway Companies made the following requests:

- Authorization to replace the B31 sign with a M2 sign of extension positioned under the B14
- Extension of the scope to the entire networks of participating Motorway Companies.

A new decree was issued on 09.08.2017.

A request is underway for the extension of this experiment for 2 additional years, this one having to end in 1 year. Indeed, the highway companies wish to have more results to evaluate this experimentation in a relevant way, especially since the extension of the geographical experimentation to all the networks is authorized only since the decree of 9 August 2017.

#### ○ CONTACTS

Annie Canel - Operations Director – ASFA (annie.canel@autoroutes.fr)

Patrick Lory - Security Operations Officer – COFIROUTE (patrick.lory@vinci-autoroutes.com)

#### ○ REFERENCES

[1] - Decree of 21.03.2016

[2] - Decree of 09.08.2017

### 6.2.1.2. Speed Reduction Schemes on Urban Collector Road

#### ○ COUNTRY

Italy

#### ○ IMPLEMENTATION ORGANIZATION

Municipality of the City of Firenze – University of Firenze

#### ○ SUBJECT

The case study describes a set of safety countermeasures which are being implemented in via Pistoiese (Firenze – Italy), that is an urban collector road classified as a high accident concentration section within the Firenze road network.

Via Pistoiese connects a suburb area, on the west, to the city of Florence, on the east. At the same time, it gives access to two crowded residential and commercial areas placed along both its sides. The dual role of Via Pistoiese, the one of urban collector road, carrying out a mobility function, and the other of local road, carrying out an access function, gives rise to great safety problems due to multiple interactions between road users (vehicles, buses, HG vehicles, motorcyclists, pedestrians). Moreover, the road layout (a 3 km long straight with just one intermediate bend) and the lanes excessive width (two 5,5 m wide lanes, one in each direction) induce vehicle drivers to increase their speed when the traffic constrain reduces (Figure 6.156 and Figure 6.157). Repeated speed measurement campaigns and the analysis of the observed accidents identified the excessive speed, much above the speed limit of 50 km/h, as the primary safety problem of via Pistoiese. This situation resulted in high frequency of accidents, often characterized by a high gravity, at the expense mainly of vulnerable road users (pedestrians and motorcyclists).

A detailed safety study has been undertaken by the Firenze municipality to identify the possible applicable safety countermeasures. Accident analysis, road safety inspections and driving simulation studies were performed to choose the intervention to be implemented.

A safety improvement project was developed and its implementation is at present in progress. The safety intervention combines physical and perceptual treatments, the latter based of the Human Factors' principles for the design of safer road infrastructures [1].



Figure 6.156 - Map view of the section of intervention [6]



Figure 6.157 - Details of the road before the interventions: on the left, crosswalk with low visibility; on the right, the evidence of wide lanes and long straight. In both cases the trees contribute to move the focal point to the horizon [6].

#### ○ PROJECT DESCRIPTION AND SUMMARY

The safety improvement project takes the form of a set of ‘traffic calming’ countermeasures. Together with a new definition of the parking spaces, the regulation of the left turn manoeuvres and the reorganization of circulation in the districts around via Pistoiese, the intervention combined several measures, including;

- the re-organization of the cross section of the street, with reduction of the lane width to 3,00 – 3,50 m, the implementation of a continuous raised median and the introduction of a third central lane serving alternatively the west and east traffic directions (Figure 6.158 and Figure 6.161);

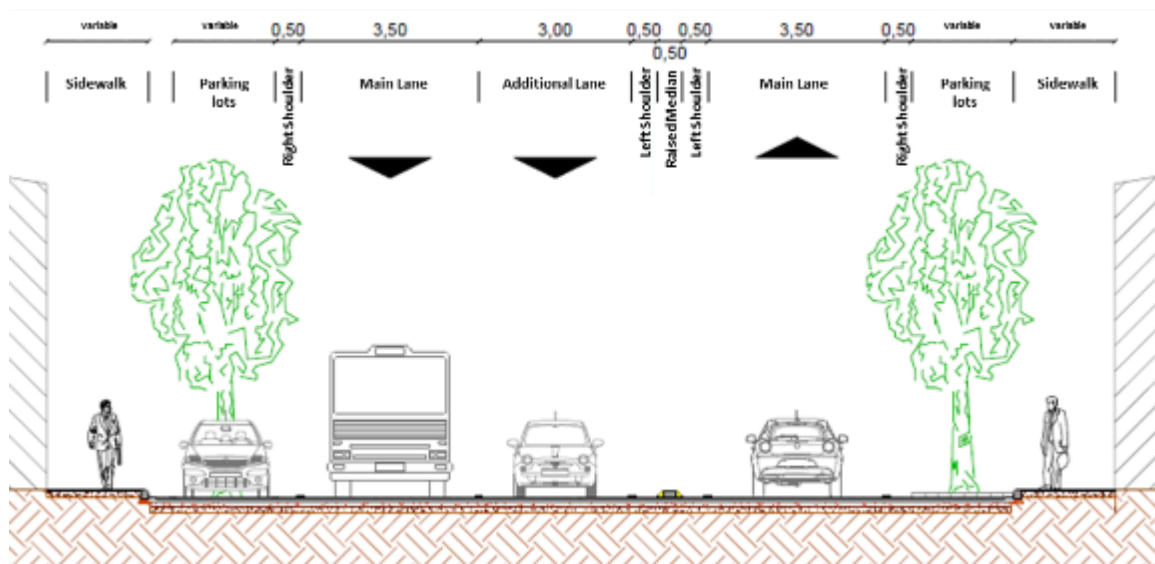

Figure 6.158 - Example of new road with 2+1 lanes cross section designed by the project.

- the construction of raised platforms in correspondence of the intersections and at the pedestrian crossings (Figure 6.159);
- the insertion of optical cues to move closer the drivers’ vanishing point, consisting in coloured portions of the roadway in correspondence of the raised intersections and crosswalks and in yellow bollards along the edge of the



roadway at the points where the carriageway in one direction changes its organization from two to one lane (Figure 6.159, Figure 6.161 and Figure 6.162);

- the implementation of coordinated traffic signals at intersections and isolated crosswalks;
- the redesign of the street lighting system to enhance the visibility of the intersections and crosswalks.



Figure 6.159 - Details of the designed countermeasures: on the left, yellow bollards in a change of the cross section, on the right, a raised coloured intersection. Both the countermeasures capture drivers attention alerting them of a critical point and moving the focal point closer.

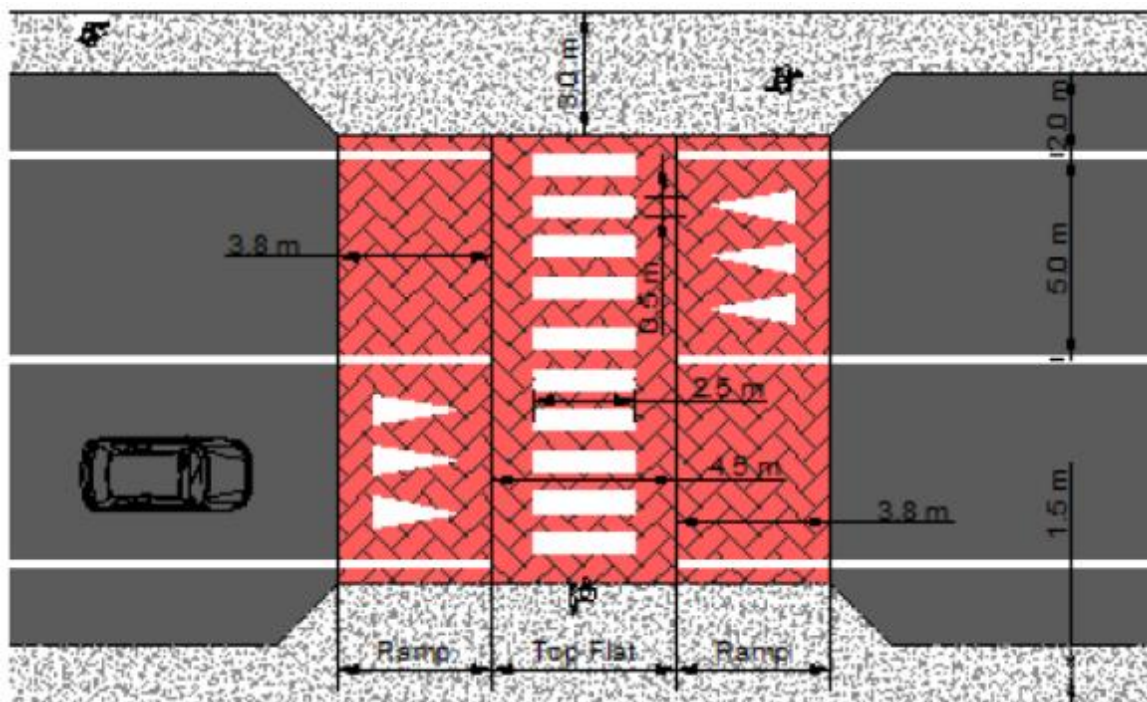

Figure 6.160 – Details on hump design



The expected impact on traffic safety of the project was evaluated by means of a virtual reconstruction of the project and an experimental campaign at the LaSIS driving simulator [5]. Some alternative solutions were analyzed in the simulation study.

According to the positive results of the simulations performed, the Municipality of Firenze decided to implement the project and the construction phase is at present in progress.

#### ○ KEY RESULTS/ACCOMPLISHMENTS

The simulation experiment showed a general reduction of the speed actuated by the drivers along the reconfigured layout of via Pistoiese compared to the existing situation. Figure 7 shows the obtained speed profiles (the 'red' lines represent the speed profile and the average speed obtained driving along the existing via Pistoiese; the 'blue' lines the same along the reconfigured road). A 15 km/h reduction of the average speed and a general major respect of the 50 km/h speed limit were obtained.

Furthermore, while approaching crosswalks, drivers tend to start breaking earlier, increasing safety for pedestrians.

After the completion of the construction phase a check of these results will be performed on site.

A before/after accidents analysis will allow to confirm the expected increase of the traffic safety along via Pistoiese.

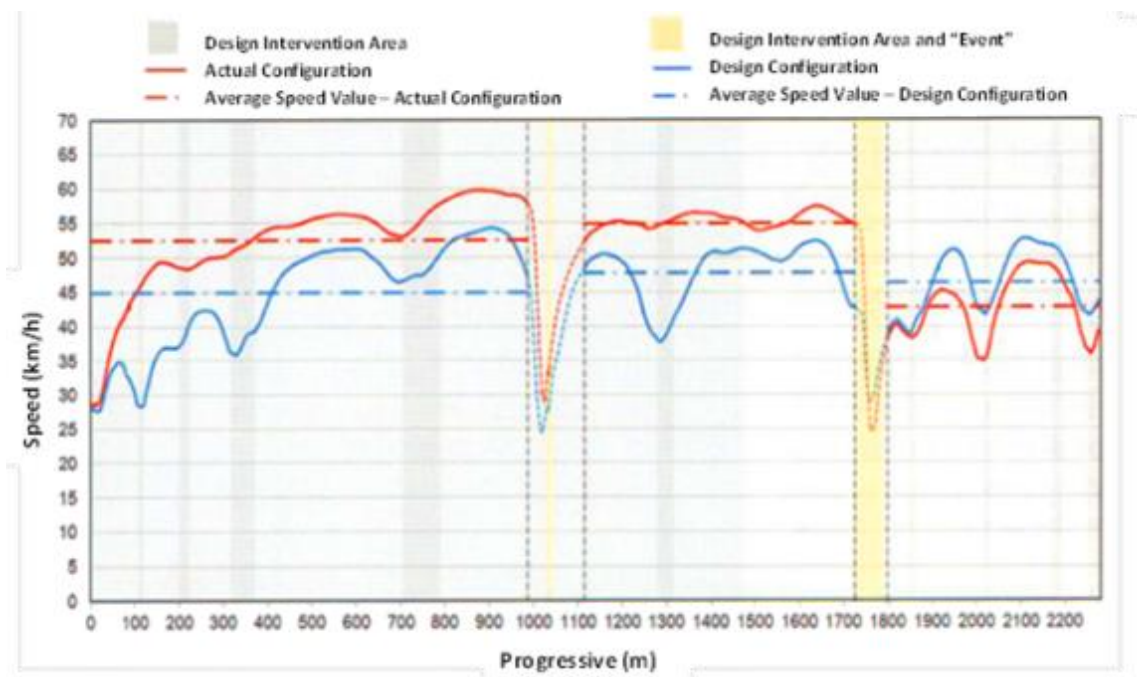

Figure 6.163 - Speeds recorded during the simulation.

#### ○ POLICIES

The experience gained with the reconfiguration project of via Pistoiese allowed to identify which type of traffic calming measures can be adopted on urban collector roads (according to the Italian Road Code, the speed bumps/humps cannot be installed on such a type of road). The results achieved could be considered in a future revision of the national Road Code.

The Municipality of Firenze is considering the possibility to extend the type of safety measures included in the via Pistoiese reconfiguration project to other urban collector roads having similar problems (penetration roads from the suburbs to the city center).

#### ○ BARRIERS/OBSTACLES

The via Pistoiese reconfiguration project faced the problem to understand how the requirements of an urban collector road, granting the mobility function to give access to the city centre, can be merged with the safety requirements of a local road, where a lot of additional interactions between road vehicles and vulnerable road users occur. Such a situation is often present in many cities around the world.

The via Pistoiese project favoured the safety aspects, that have been considered prevailing in case of conflict with the requirements of the mobility function. Many public consultations with the people living around via Pistoiese have been necessary to explain the reasons for the project and a general acceptance of the adopted conceptual approach resulted.

Anyhow, in the case of via Pistoiese, traffic microsimulation studies performed during the design phase allowed to ascertain that additional traffic congestion situations are not expectable after the implementation of the reconfiguration project. The checking of this aspect will also be considered in the after studies.

Some of the safety measures included in the project (such as the type of markings in correspondence of the up ramps of the raised portions of the carriageway) are not accounted for by the Italian legislation. This required a special authorization to implement the project as an experimental one.

#### ○ LESSONS LEARNED

Designing roads accounting for the abilities and limitations of the human being, according to the PIARC Human Factors principles for safer road infrastructures, allows to expect important benefits in terms of road safety and can help achieving the Safe System approach goals.

Driving simulation studies confirmed, in the case of via Pistoiese, the correctness of this statement.

Further future validations in the real world will hopefully confirm it.

#### ○ CONTACT

[lorenzo.domenichini@unifi.it](mailto:lorenzo.domenichini@unifi.it);

[andrea.tonelli@comune.fi.it](mailto:andrea.tonelli@comune.fi.it)

[valentina.branzi@unifi.it](mailto:valentina.branzi@unifi.it);

[andrea.palioetto@unifi.it](mailto:andrea.palioetto@unifi.it)

#### ○ REFERENCES

[1] PIARC, 'Human Factor guidelines for a safer man-road interface', 2016R20EN

[2] Comune di Firenze, Progetto David (2011),

[www.comune.fi.it/opencms/comune\\_firenze/ultime\\_notizie/e0218.html](http://www.comune.fi.it/opencms/comune_firenze/ultime_notizie/e0218.html)

[3] Laboratorio per la Sicurezza e l'Infortunistica Stradale 'LaSIS', [www.lasis.unifi.it/](http://www.lasis.unifi.it/)



- [4] L. Domenichini, F. La Torre, V. Tartaglia, V. Branzi, F. Fanfani (2014). 'Safety improvements in Urban Areas based on Human Factors principles - A case study: Via Pistoiese'. In proceeding of Ageing and Safe Mobility Conference, 27-28 November 2014, Bergisch Gladbach, Germany.
- [5] L. Domenichini, V. Branzi, M. Meocci (2018). 'Virtual testing of speed reduction schemes on urban collector roads'. Accident Analysis and Prevention, 110, 38-51.
- [6] Google Maps

### 6.2.1.3. Low Cost Engineering Measures on a dangerous trunk road: Perceptual treatment

#### ○ COUNTRY

Portugal

#### ○ IMPLEMENTATION ORGANIZATION

Junta Autónoma de Estradas (JAE - Portuguese Road Administration at the time of the study - 1998).

#### ○ SUBJECT

The case study describes the approach used in 1998 by the Circulation and Safety Division of the Portuguese Road Administration (JAE) to improve road safety on the interchanges of a single carriageway, two lane, trunk road that connected the Portuguese coastal area and Spain (route IP 5). In a first phase, Low Cost Engineering Measures (LCEM) were applied, to improve the road characteristics; in a second step, exceptionally intense and severe law enforcement actions were employed by the police, to improve driver behaviour.

LCEM are physical interventions on the road, specifically designed to enhance the safety of the road system, that have a low capital cost and can be implemented quickly [1].

The LCEM interventions were carried out on a 170 km road section, beginning in Albergaria (at the interchange with the IC 2 route) and ending in the Portuguese-Spanish frontier (see Figure 1). Several criteria dictated the choice: very high average daily traffic volumes (between 4400 and 10000 vehicles); the high traffic volumes of heavy vehicles, both in absolute numbers and expressed as a percentage of the total number of passing vehicles (between 1700 and 3450 vehicles, 17% to 32%); the importance of IP 5 in the Portuguese road network in those days, due to its use by a significant percentage of the international road traffic originating or arriving to Portugal; the high number of casualties resulting from road accidents (35 fatalities and 37 serious injuries in 1997, as a consequence of 508 accidents), as compared with other similar roads; and some notable accidents that were thoroughly covered by the media (see Figure 6.164).

This case study is about interventions in approach zones to the interchanges on IP5.



Figure 6.164 - The cover of a weekly magazine about IP5 “The death road” (October 1997)

#### ○ PROJECT DESCRIPTION AND SUMMARY

This section of IP 5 was built in the 1980's, as a by-pass to EN 16, an old national road connecting the same destinations and that crosses the towns of Viseu and Guarda. The layout of this “EN 16

by-pass” had modified quarter cloverleaf interchanges, with T junctions on the roads linked and the roads crossing at split-level.

In 1985, as a result of the approval of the new National Road Plan, the “EN 16 by-pass” was classified as a Main Route (IP – classified trunk road) and reconstructed accordingly. It was the first IP to be completed as such. The road design was changed during the construction phase, mainly in what concerns the layout of the interchanges [2].

The design changes consisted mainly in: modifying the interchanges, into new ones without left turns on the main road – although, in some cases, with some substandard design parameters; the introduction of additional climbing lanes; the introduction of rest areas, service areas and parks; the introduction of escape ramps with arrester beds; and the implementation of an integrated alert and information system, which included a network of emergency telephones (spaced 3 km), and meteorological stations and escape ramp occupancy detectors (both associated to variable message signs).

Head-on collisions and run-off-the road (namely on curves, on approach zones to interchanges, and on sections with climbing lanes) were the most frequent types of accidents occurring in IP 5. These accidents were mostly related to speeding and miscalculated overtaking.

In the late 1990’s, a major renewal of the IP 5 layout was already being planned, with the introduction of double carriageway in several links and its future upgrading to a motorway (currently renamed as A 25, constructed between 2003 and 2006). While this reconstruction was not fully implemented, LCEM were implemented to quickly improve road safety conditions in the section between Albergaria and Vilar Formoso.

Three subsets of measures were defined, as summarised below [3]:

- a) Traffic safety improvement on interchanges, namely by improving their legibility and visibility, and by ensuring a better operation uniformity and predictability for traffic leaving and entering IP 5 (see Figure 6.165);
- b) Overall improvement of traffic operation and safety, using changes in road environment and measures to influence driver behaviour;
- c) Traffic operation improvement on sections with climbing lanes, namely by application of traffic regulations increasing the number of passing opportunities for cars.

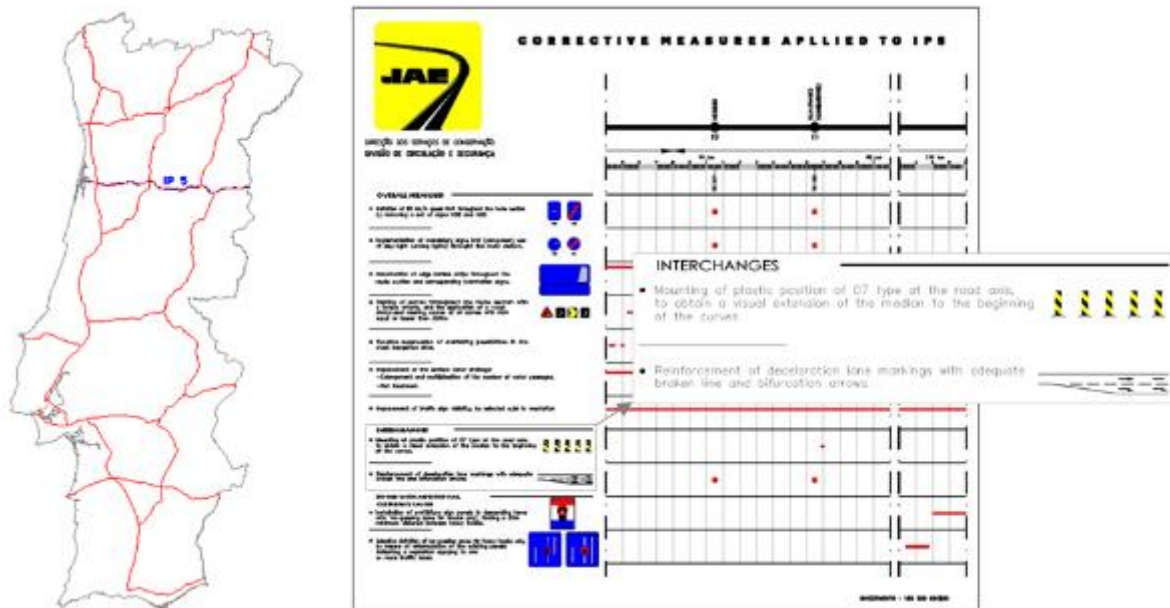

Figure 6.165 – Location of IP 5 on the Portuguese trunk road network (1998) and schematic layout plan of corrective measures (example)

Measures in the first subset included the installation of plastic position marker posts type O7 (Portuguese Highway Code Regulation) at the road axis on the approach to curved interchange medians. Marker posts spacing was set according to the curve radius (see Table 6.6 – Spacing between posts as a function of horizontal curve radius). In this way, a visual extension of the median was obtained up to the beginning of the curves, which alleviates the surprising effect described, and provides a supplemental tool to prevent overtaking on these sections (Figure 3).

Curve radius (m)	300	350	400	450	500	550	600
Spacing (m)	5.0	6.0	6.5	7.0	8.0	9.0	10.0

Table 6.6 – Spacing between posts as a function of horizontal curve radius

The first subset of measures [3] was aimed at improving the operation and safety at the interchanges, which were mostly located at or near horizontal curves, and physical medians shorter than the corresponding curve. This resulted in the sudden and unexpected appearance of the median to unfamiliar drivers. The corresponding late detection of the median triggered head-on collisions on approach zones to these interchanges.

Thirteen interchanges were intervened with the installation of marker posts in a total length of 3000 m.





*Figure 6.166 – Visual extension of the median to the beginning of the curve in two interchanges*

The position marker posts (see Figure 6.167) consisted of an individual base, in white colour, a rubber shock absorber and a vertical plastic blade, with yellow and black stripes (Portuguese permanent signing chromatic criteria). This blade was 15 cm large (equal to the distance between the two longitudinal continuous lines) and 50 cm long and the yellow colour obtained with level 2 retroreflective sheets. The base was fixed to the pavement with expansive screws and two component glue.



Figure 6.167 – Type O7 plastic position marker posts at the road axis

The first subset of measures [3] was aimed at improving the operation and safety at the interchanges, which were mostly located at or near horizontal curves, and physical medians shorter than the corresponding curve. This resulted in the sudden and unexpected appearance of the median to unfamiliar drivers. The corresponding late detection of the median triggered head-on collisions on approach zones to these interchanges.

Therefore, drivers did not have the time necessary to adapt to the new and unexpected situation, as dictated by the physical median and the associated transition of the road cross section. The installation of adequate devices on the axis of the road was intended to visually bring the median to the beginning of the horizontal curve and have eye-catching objects in the road axis providing good optical guiding.

This countermeasure covered the three Human Factors rules (*the 6 Seconds, the Field of View and the Logic*): the drivers were alerted to the existence of a physical separation well before the bended median; the position marker posts - eye catching objects in the road axis - organized the field of view, creating a clear line of reference; and provided a warning/transition zone for the changing road characteristics at the interchanges approach zone, from a single carriageway to a double one.

#### ○ KEY RESULTS/ACCOMPLISHMENTS

As a result of the set of measures implemented general driver behaviour became more homogeneous.

Safety impacts were analyzed using an observational before-after study, with all other Portuguese Road Network IP category roads as control sections. The expected number of accidents were used as the safety performance variable, and the multivariate regression empirical Bayes method described by Hauer [7] was used in the analysis. A four year “before” period (1994-97) was considered; the “after” reporting period consisted of years 2001 and 2002. Years 1999 and 2000 were not used because in that period a strong and strict enforcement activity was applied throughout the whole IP 5 road, leading to a massive reduction in the annual number of injury accidents and victims. Strict enforcement was abandoned, and regular enforcement re-established before the end of 2000.

In this study it was concluded that the number of expected injury accidents was reduced by 12% due to the LCEM, from 428 to 377 injury accidents (also, a reduction of 41% was estimated, as resulting from the compound effect of LCEM and strict enforcement). The annual number of registered fatalities was reduced from 85 to 52 (by 39%), and the annual number of killed and seriously injured victims diminished from 188 to 125 (by 34%) [8].

#### ○ POLICIES:

The systematic application of low-cost road and traffic engineering measures (LCEM) at high risk road sections is a cost-effective method of reducing accidents and their consequences. Furthermore, considering the usual time-span of the road infrastructure life cycle, it is a fast method, as well. Usually associated with the correction of high-risk road sites (also known as ‘black-spots’), LCEM may be applied also to high-risk route sections, as in the described example.

It was the first time that LCEM were applied in Portugal to a route section. The extent and unprecedented nature of the measures proposed and applied were the reason for having a research institute (LNEC) evaluating their impact on accidents and driving behaviour.

In fact many of these LCEM were used for the first time in Portugal: continuous rumble edge lines; consistent signing of curves throughout a route section; compulsory use of daylight running lights; definition of no-passing zones for heavy trucks on climbing lane sections; and specially the use of position marker posts at the road axis to provide a non-physical median, which was unprecedented in Portugal and, perhaps, in Europe.

Afterwards, the exceptionally intense and strict law enforcement actions employed by the police throughout the route section were also applied for the first time in Portugal [6].

#### ○ BARRIERS/OBSTACLES:

Once the idea of using a device on the axis of the carriageway to provide a visual extension of the median to the beginning of the curves was decided, it was imperative to select an adequate device that might be understood by the drivers as a sign included in Highway Code Regulation (HCR). Several types of posts were analysed and one type with similar design (two stripes) and colour code to the position marker post considered in the HCR – the type O7a position marker post, Figure 5 – was used. The HCR prescribes that it indicates the position and limits of obstacles in the carriageway.

A CAD tool was used to assess the most appropriate spacing between marker posts for the different curve radii. However, these empirically determined spacing criteria needed to be validated on the road. For this purpose, the highway police (GNR-BT) controlled the traffic during the pre-positioning at pilot curves, where the marker posts positioning were further evaluated visually and observation of road users' behaviour in face of these new devices were carried out *in situ*. Only after the evaluation of these pilot curves was the system applied to the other curves on the IP 5.

The JAE's Circulation and Safety Division quantified *in situ* and coordinated the implementation of the LCEM proposed, with the cooperation of the JAE's District Directors of Aveiro, Guarda and Viseu.



07a – Baliza de posição

Figure 6.168 – Position marker post from the HCR

○ LESSONS LEARNED:

The use of new types of LCEM on a road must be decided with great caution and using before-after studies, to confirm that their impact in road safety and driving behaviour is in line with original objectives.

They should not be used in other situations that do not correspond to the same type of problem to which the countermeasure was applied. Following the use of these devices on IP 5, they were used in several situations where its need and effect were not at all applicable (see example on Figure 6.169).





*Figure 6.169 – Inadequate use of plastic position marker posts at the road axis (before a New Jersey or DBA barrier from which the traffic is not protected due to the absence of an appropriate terminal)*

○ COSTS:

The three sets of corrective measures of the road infrastructure were executed during the first semester of 1998 (see Figure 1 [4]). The total cost of these interventions was about 925 000 €, about 5 400 €/km [5] (at 1998 prices).

Experience has shown that benefit/cost ratios between three and 24 may be achieved, in countries where moderate to high monetary values are attached to the prevention of death and injuries resulting from road accidents (FHWA, 1993). No cost/benefit analysis was carried out for this set of LCEM; however, the reduction in the expected annual number of injury accidents corresponds to an annual social cost of 370 500 €, at 1995 prices [9].

○ CONTACTS:

Carlos de Almeida Roque - [carlosalmeidaroque@gmail.com](mailto:carlosalmeidaroque@gmail.com);

Dr. João Lourenço Cardoso - [joao.lourenco.cardoso@gmail.com](mailto:joao.lourenco.cardoso@gmail.com)

○ REFERENCES

- [1] ETSC “Low-cost road and traffic engineering measures for casualty reduction”. Brussels: European Transport Safety Council. 1996.
- [2] Nascimento, A. “IP5 - Improvement of operational conditions” (in Portuguese language). Junta Autónoma de Estradas. Almada, Portugal. 1996.
- [3] Almeida Roque, C. “IP5 Improvement of safety conditions” (in Portuguese language). Informação N° 97/DSCs/DCS. Junta Autónoma de Estradas. Almada, Portugal. 1998.
- [4] Macedo, A. L., Almeida Roque, C. “Low cost measures for safety improvement - Considerations about their application in Portugal”. Seminar “Medidas de Engenharia de Bajo Coste para Carreteras más Seguras”. Association Española de la Carretera and European Transport Safety Council (ETSC). Bilbao, Spain.1998.
- [5] Impact of Traffic and Safety Measures on Driver Behaviour on the IP 5 Road (2nd Report) (in Portuguese language). Cardoso, J. L. LNEC. Lisbon, Portugal. 2000.
- [6] Almeida Roque, C., Cardoso, J.L. “Low cost engineering measures and stricter enforcement. A successful combination to improve road safety on a dangerous rural route”. Routes/Roads N° 311, July 2001. World Road Association (AIPCR/PIARC). Paris, France.
- [7] Hauer, E. “Observational Before-After Studies in Road Safety”. Tarrytown, New York. Pergamon/Elsevier Science, Inc.
- [8] Cardoso, J. L. “The effect of low cost engineering measures and enforcement on driver behaviour and safety on single carriageway interurban trunk roads”. In Advances in Human Aspects of Road and Rail (ISBN 9781439871232).
- [9] Macedo, A.L.; Cardoso, J.L.; Arsénio, E.; Dionísio, A.; Figueiredo, A. – Participation of LNEC on the studies on allocation costs of using transport infrastructures. 2nd Report. Report nº 59/00; NTSR, Procº 093/01/13563. LNEC, Lisboa, March 2000 (in Portuguese language).

#### 6.2.1.4. Re-arrangement of a pedestrian crossing on DN 28, in Bălțați, Iași county

○ COUNTRY

ROMANIA

○ IMPLEMENTATION ORGANIZATION

C.N.A.I.R. S.A. – D.R.D.P. IAȘI prin S.D.N. Bacău

○ SUBJECT

The road sector on which is located the intersection was rehabilitated during the period 2000-2003, the road being designed with two lanes and the projected width of the platform having the value of 12.00 m. As a result of the increase of the traffic values, both transit traffic as well as traffic attracted as a result of the socio-economic development of the area has increased the number of collisions at this point, so an analysis of these events has been carried out, as a result of which it became necessary to improve the degree of safety for road traffic, by arranging dedicated lanes for turning left maneuvers.

○ PROJECT DESCRIPTION AND SUMMARY

The road sector DN 2 km 254 + 000 - km 282 + 300 was the object of the national roads rehabilitation works carried out during the period 2000 - 2003. According to these works, the geometrical features of the cross section of the road were designed as follows:

- 2 lanes x 3.50 m each, one/sense

- 2 reinforced shoulders with the role of emergency lane x 2.50 m, one per sense

In 2003, at the end of the works, DN2 intersection with the DJ 252D it was at the outside of the locality, about 550 m from the entrance to Nicolae Bălcescu. According to the project, the intersection was only set up with smallest islands with curbs, located on the DJ 252D, the cross-section of DN 2 being unchanged.

As a result of the urban development, the built area of the commune has increased, along the way, to Bucharest, the built-up area of the locality thus encompassing almost the whole area of the intersection. At the same time, the volume of traffic attracted by the secondary road increased, including by building economic objectives in the immediate vicinity of the intersection. In this context, there was also a slight increase in the number of collisions in the intersection area, which gave some concern to the road administrator and to the traffic police.

It has become necessary to reconsider the way of organizing the road traffic at the intersection DN 2 with DJ 252D. Two solutions have been evaluated:

A. Building dedicated lanes for left and right turns from DN 2 to DJ 252D, the platform width required for such a fitting is:  $3.5 + 3.5 + 3.5 + 3.5 + 2 \times 0.50 = 15.00$  m

B. Setting up a left turntable from DN2 in the DJ 252D as well as a pocket-tape in its extension, so that the traffic on the DJ 252D that is going to turn left into the DN 2 to perform the maneuver in two stages. The width of the platform required for such an arrangement is:  $3.5 + 3.5 + 3.5 + 2 \times 0.75 = 12.00$  m

Due to economic reasons, version B was adopted, in the first stage the arrangement was done only with road markings and signs, and depending on the results of the monitoring of this arrangement,

at the later stage, the opposing traffic routes would be separated by a curb island, built on the traffic-free space on DN 2.

The first stage has been accomplished so far, and after the arrangement, the number of collisions in the intersection area was reduced, as well as the improvement of the traffic flow.



Figure 6.170 – General view of the site before the intervention



Figure 6.171 – Detailed view of the site before the intervention, zoomed



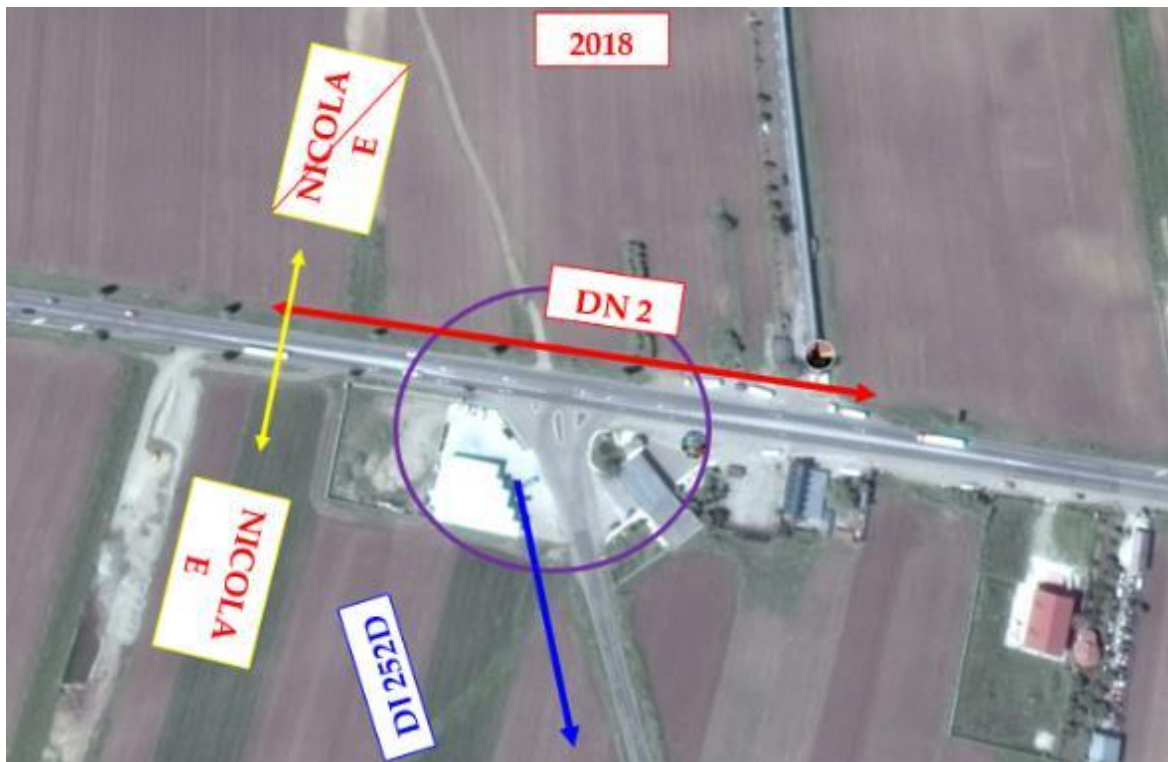

Figure 6.172 – General view of the site after the intervention



Figure 6.173 – Detailed view of the site after the intervention



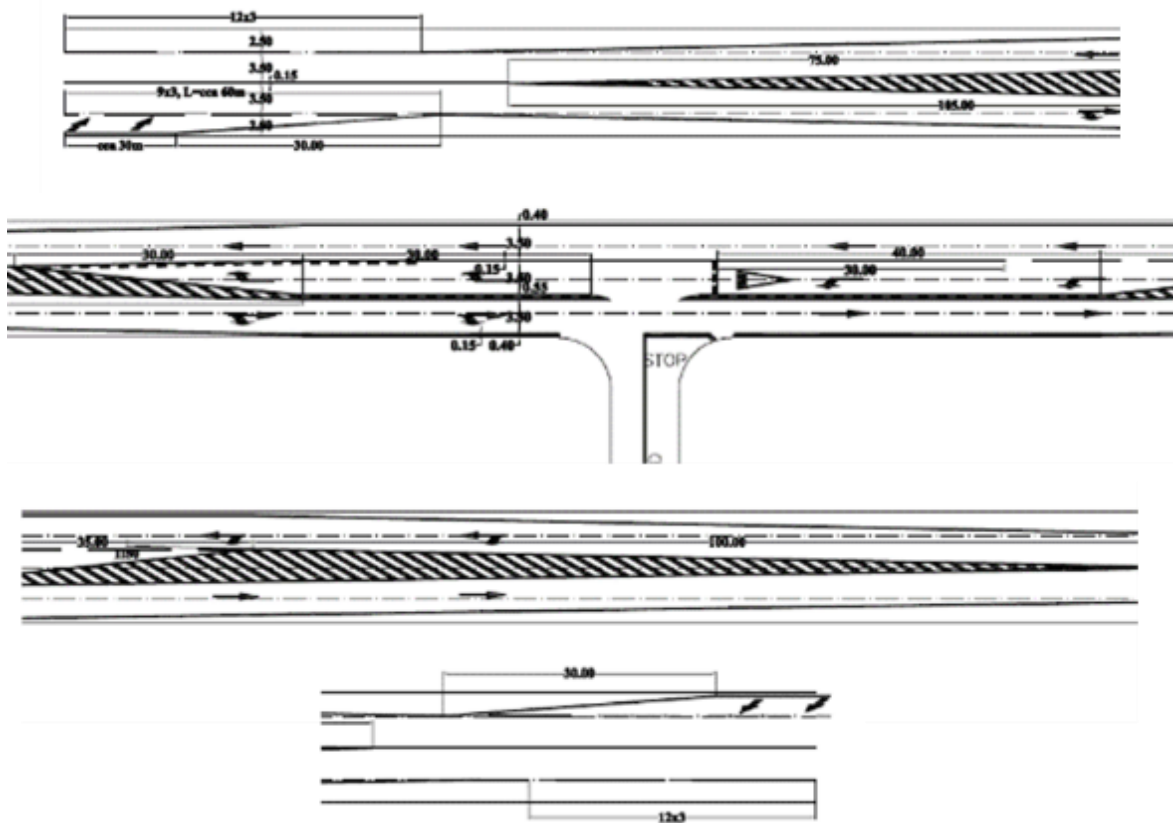

Figure 6.174 – Design of the intersection. The sketch refers to the general arrangement, regardless of the geometric characteristics of the secondary road; it was paid attention only to the arrangement of the intersection on the main road



Figure 6.175 – View from the road before the intervention



*Figure 6.176 – View from the road before the intervention, closer to the intersection*



*Figure 6.177 – View from the road after the intervention*



*Figure 6.178 – View from the road after the intervention, closer to the intersection 1*



Figure 6.179 – View from the road after the intervention, closer to the intersection 2

#### ○ KEY RESULTS/ACCOMPLISHMENTS

Dynamics of traffic accidents in the DN 2 km area 275 + 500 - km 276 + 200, were the following:

Period	Collisions	Victims	
		Deceased people	Seriously injured
2005 - 2009	10	4	6
2010 - 2015	5	1*	6

Table 6.7 – Dynamics of the accidents in the intersection area. \*The cause of the accident in which the death was recorded was the failure to give priority to traffic on DN 2, the mechanism was side collision between two cars. Two of the six seriously injured were also registered in this accident.

#### ○ POLICIES

Following the realization of the respective arrangement, the road traffic is guided by traffic signs and road markings, the latter having the decisive role in ensuring road safety, in that the circulation of traffic flows on each destination is leading by spatial separation, out of conflict points.

#### ○ BARRIERS/OBSTACLES

In order to accomplish this arrangement, it was necessary to cooperate very well between the Road Police, on the one hand, as an institution responsible for managing traffic events and the one that holds the information regarding the collisions produced in the respective area and the Regional Directorate of Roads and Bridges Iași, together with National Road Section of Bacău, on the other hand, as the administrator of the respective road and responsible for ensuring the conditions of safe traffic, according to the laws in force. This co-operation has, in some places, encountered some bureaucratic obstacles that have, however, been overcome by the benevolence of the actors involved. Once the causes of the collisions have been established, through the cooperation process described above, the solution has been developed jointly and the implementation was carried out by R.D.R.B. Iași through N.R.S. Bacău, after its approval by the Police Road Service Bacău.

- LESSONS LEARNED

The design phase did not take into account the real increase in traffic values in the intersection area, so that the dedicated bands for the left turn were not designed. For such situations to happen as rarely as possible, we consider as imperative that, at least all the projects of important road works (national roads, county roads, communal roads), respectively rehabilitation works, capital repairs, modernization, construction new roads, etc. to be thoroughly analyzed, including by carrying out the Road Safety Impact Assessment and Road Safety Audit, so as to identify and correct, from the early design phases, the deficiencies that may lead to serious events in the road infrastructure operation stage.

- COSTS

20.000 euros including VAT (approximate costs)

- CONTACTS

Iulian-Cătălin Dimache [catalindimache@yahoo.com](mailto:catalindimache@yahoo.com); [catalin.iulian.dimache@gmail.com](mailto:catalin.iulian.dimache@gmail.com)

Ștefan Dinco [stefd2005@yahoo.com](mailto:stefd2005@yahoo.com)



## 6.2.2. Case Studies dealing with the Spatial Perception Rule of the Human Factors principles

### 6.2.2.1. Guizhou province anshun city X462 road

#### ○ COUNTRY

China

#### ○ IMPLEMENTATION ORGANIZATION

Research Institute of Highway MOT

#### ○ SUBJECT

This case study mainly focuses on the roadside hazards and curve protection of the typical steep downhill and sharp turning section on the rural road X462 in Anshun City, Guizhou Province, China. The object of the project is to reduce roadside hazards and ensure curve safety through effective countermeasures, such as 1)Improving the curve delineation, 2)Adding speed management measures, 3)Adding concrete barrier on the outside of the road, based on these countermeasures to achieve the goal of improving the overall road safety level.

#### ○ PROJECT DESCRIPTION AND SUMMARY

The project is provide some safety countermeasures aim to the typical steep downhill and sharp turning section, the existing outside of the curve are warning piers, and the anti-collision performance is not enough. The countermeasures in this section mainly including: 1) Improving the curve delineation such as drawing centerline and setting linear guidance signs, which will help guide the driver in driving; 2) Adding vibration deceleration markings at steep slope sections to prompt the driver to slow down and force to deceleration by facilities; 3)Adding concrete barrier on the roadside to prevent vehicles from run out of the road due to excessive speed when driving downhill. The objective of the project is reduce roadside hazards and ensure curve safety.

#### ○ KEY RESULTS/ACCOMPLISHMENTS

After implementing a series of safety improvement measures on the steep downhill and sharp turning section, the anti-collision performance of the section has been greatly improved, and some results have been achieved in the following areas:

1 Through counting the number of road accidents before and after the implementation of safety measures, it was found that after the project was implemented, the number of accidents was relatively reduced.

2 Through the measurement of the operating speed data of the section before and after the implementation of safety measures, it was found that the speed of motorcycles, vehicles, etc. have all significantly decreased in the steep downhill and sharp turning section after the project was implemented.

3 Through the risk assessment model to calculate the risk value of the section before and after the implementation of safety measures, it was found that after the project was implemented, the risk value of the section decreased significantly, and the risk level changed from the most dangerous 5 levels to medium 3 levels.



Figure 6.180 - The above two figures are comparison of before and after the implementation of security countermeasures

#### ○ POLICIES

1 Build a lifeline for traffic safety in rural areas, strengthen attention, strengthen management, and enforce responsibilities, strengthen rural traffic safety management, and prevent serious illegal acts such as rural bus overload, non-bus manned and drunk driving.

2 Conduct network-based troubleshooting for sections of cliff, sharp bends, and steep slopes, etc., and supervise the entire process of improve safety of roads which are potential road hazards.

3 The city strictly enforces the responsibility for road traffic safety, strengthens the supervision of road traffic safety, and conducts solid inspections for hidden troubles.

#### ○ BARRIERS/OBSTACLES

There are two barriers during the process of safety improvement of the steep downhill and sharp turning section:

1 The steep downhill and sharp turning section usually appear in mountainous areas with poor geographical conditions with limited economic capacity, so it is essential to consider the economic rationality as much as possible when carrying out the recommended safety countermeasures.

2 The restrictions on the surrounding environment of roads lead to the risk of steep downhill and sharp turning cannot be reduced by change road curvature and grade. It is only possible to improve the safety of such sections by improving the driver's driving behaviour and increasing roadside protection.

#### ○ LESSONS LEARNED

1 Adequate delineation can provide drivers with road information, so that drivers can adjust right drive status. In the sharp curve section the curve linear induce signs should be perfected to guide the driver. Warning signs shall be set up in front of villages, towns, sharp bends and steep slopes.

2 In the school road sections, sharp bends and steep slopes sections and multiple accidents sections due to excessive speed, set stone pavements or deceleration vibratory markings to reduce the driving speed.

3 In cases where sight distance is limited, improve sight distance should be done by clearing obstacles or by adjusting the linearity of the road. For example, installing a convex mirror on a sharp bend will increase the sight distance.

4 For roadside sections with high risk factors, such as cliffs, deep valleys, deep ditch, rivers and lakes, projects should focus on these road sections. An effective way is to install road safety barriers.

#### ○ COSTS

There are some estimated upgrade cost of whole project safety countermeasures, for the steep downhill and sharp turning section in the project is 200 meters, so based on the unit of upgrade cost, the approximate cost is CNY 72800.

Countermeasures	Unit of cost	Upgrade cost(CNY)
Centerline	per km	2000
Vibration deceleration line	per km	5000
Curve Linear induce signs	per km	7000
Roadside safety barriers	per linear km	350000

#### ○ CONTACTS

Dr. Chengcheng TANG E-mail : [973939419@qq.com](mailto:973939419@qq.com)

#### ○ REFERENCES

- [1] Technical standard of Highway Engineering (JTG B01-2014)
- [2] Road traffic signs and markings (GB 5768-2009)
- [3] Design Specification for Highway Alignment (JTG D20-2006)
- [4] Specification for Design of Highway Traffic Safety Facilities (JTG D81-2006)
- [5] Specification for Design of Highway Traffic Signs and Markings (JTG/T D82-2009)
- [6] International Road Assessment Programme (iRAP) technology, <http://www.irap.org/>
- [7] Guide for Implementation of Improve Highway Safety to Cherish the Life Project

### 6.2.2.2. Floor Markings Combatting Motorcycle Crashes in Rural Left-Hand Curves

#### ○ COUNTRY

Austria

#### ○ IMPLEMENTATION ORGANIZATION

Kuratorium für Verkehrssicherheit (KFV, Austrian Road Safety Board) in cooperation with the regional road administrations of Niederösterreich (Lower Austria), Kärnten (Carinthia) and Burgenland

#### ○ SUBJECT

Research has shown that cutting left-hand curves is very common among powered two-wheeler (PTW) riders. Less than 5% of riders were found using a safe trajectory on the outside of a tight curve on a rural road with low forward visibility. 16% would touch and 79% would hit an oncoming bus with full overlap (Winkelbauer, 2014). In figure 1, both motorcycles appear in their original position, the left rider missed the bus by some seconds only. Nevertheless, it is not that cutting curves typically causes head-on collisions. They make up only 2% of the crashes involving PTW. Much more common is that riders master a swerving manoeuvre, but then either fail to reduce their speed on time or fail to cope with the increased roll angle, which is then necessary to stay on the track. It is supposed that at least 50% of run-of-the-road accidents in rural left-hand curves (8% of all PTW crashes) are caused by riders losing control of their PTW after having swerved around an oncoming vehicle.

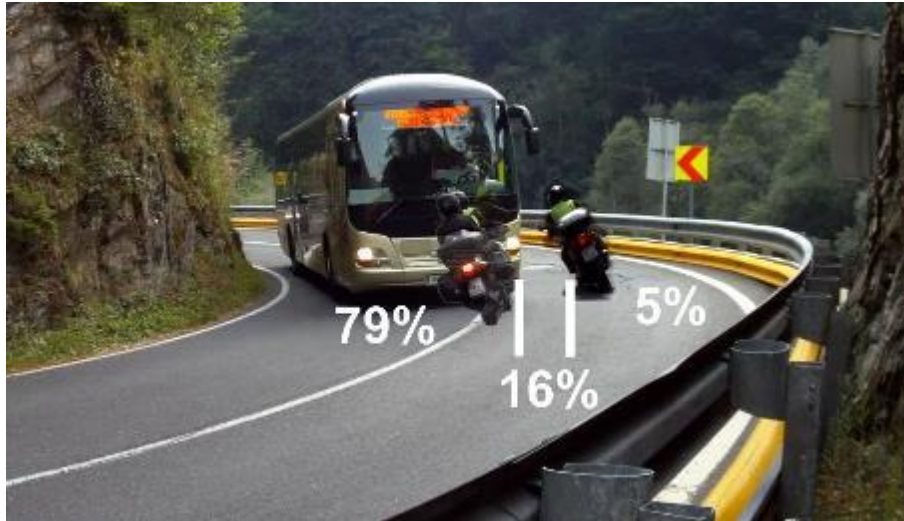

Figure 6.181 - Photo composition. Share of riders' trajectories

#### ○ PROJECT DESCRIPTION AND SUMMARY

After a careful investigation of relevant locations considering crash records, the experience of regional road administration and local road managers and issues of road condition (e.g. ruts, cracks, potholes, existing floor markings, etc), a set of nine suitable curves in the Austrian regions of Burgenland, Lower Austria and Carinthia were identified. Two different shapes of road markings were selected as a treatment (Figure 6.182): "bars" (also called "psychological brake") and an elliptic design, which already had been tested in an earlier pilot study (Winkelbauer et al, 2014). The underlying principle is that PTW riders avoid riding over floor markings since they are said to be slippery. The intervention makes use of this strong believe within the target group. For



application, 3M's Stamark 380 sheet material was chosen, since it has high friction (in contradiction to what riders believe), is very easy and fast to apply, it can be tested before final application (i.e. for test rides before final bonding) and it had proved to withstand winter service for at least three years, which was very relevant for the respective roads. The final layout was tested on the spot by an experienced motorcycle rider. It is key that the floor markings create a smooth trajectory through the curve, which is difficult to design on the drawing board (in particular because there was little experience with this exercise at that time). The final application took place in mid-summer 2016 to allow sufficient time for observation before and after the intervention.



Figure 6.182 - a) “bar” (or “psychological brake”) layout, b) elliptic design

#### ○ KEY RESULTS/ACCOMPLISHMENTS

The effects were investigated using hidden video observation. Three cameras were installed, at the entry, the vertex and the exit of each curve and left there for one day both before and after the intervention. External batteries and huge storage media were used in order not having to touch the camera throughout the day. Even the slightest movement of the camera could have interfered with the automatic video processing (trees moving in the background were badly enough impeding the software to isolate episodes with PTWs present). The trajectories were assessed manually using a specifically developed graphical user interface. Five categories of trajectories were introduced (see Figure 6.183).

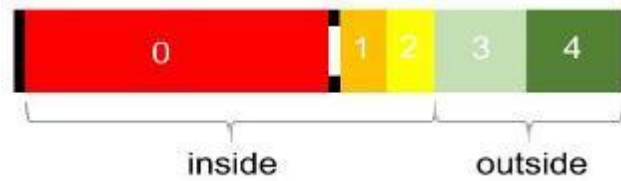

Figure 6.183 - Horizontal classification of trajectories

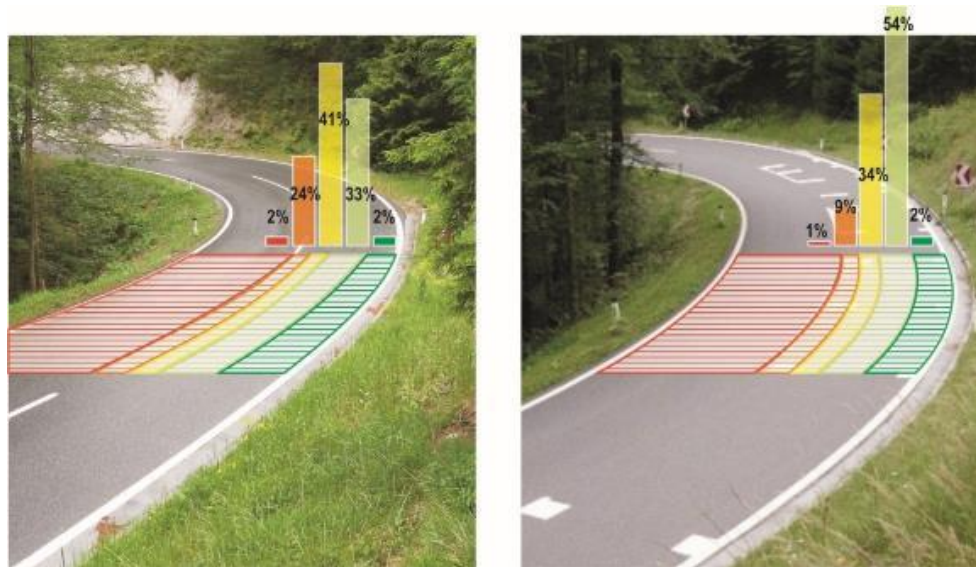

Figure 6.184 - Effects for all curves: Riders' trajectories a) before, b) after the intervention

The results showed significant effects for both bars and elliptic shape. The share of riders within the dangerous sections 0 to 2 significantly decreased after the intervention, from 64% to 44% at the vertex. The elliptic shape performed slightly better (77% to 41%) than the bars (60 to 48%). Figure 6.184 shows the distribution of riders' trajectories at the vertex before and after the intervention as an average of all curves. Favorable significant effects were also found for beginning and exit of the curves. The findings are based on a total of almost 20,000 observations. The effects on driving speed were negligible. Any effects on other road users than PTW riders were not observed.

The observational study was complemented by an interview survey. 106 interviewees were mostly very positive about the floor markings and their effects. The bars worked more intuitively, the elliptic design raised more attention. Chopper riders were most positive about following the trajectory suggested by the floor markings, however, they were worst in actually following this trajectory in the observational study. Naked bike and dual sports bike riders were most harmonic in terms of appreciation of the markings and their actual behaviour.

#### ○ POLICIES

The process of implementation is currently (2018) going on about two years after the intervention, respectively one year after publishing the evaluation study. The markings were so far applied in the sense of a scientific trial, but should be transferred into a regular legal standard. The first step towards application is to include the markings in the respective technical standard on design of floor markings. Most difficult within this exercise is giving reasonable advice about how to design a smooth and safe trajectory, where to start with the markings ahead of a curve and how to avoid "catching" riders on the wrong side of the markings, if they should approach a curve too far to the

left (most likely caused by a bad trajectory in the previous curve). There are various other issues to consider, such as ruts, potholes or manholes on the planned trajectory, and particularly the road alignment before and after the respective curve. So far, a comprehensive recommendation has not been settled yet. Nevertheless, the intervention is a promising candidate to enter the new Austrian Road Safety Program for the 2020s.

Another Austrian region (Styria) has already adopted the application, eleven dangerous curves were treated using the bar shape. In addition, the Grossglockner Hochalpenstrassen AG (GROHAG, a private road owner) has treated the six most dangerous curves on his routes using the elliptic design in early 2017 (GROHAG, 2017).

#### ○ BARRIERS/OBSTACLES

Application of such an innovative measure bears a twofold risk to a road administration. On the one hand, a single crash could – despite careful considerations and well-reflected planning – happen and – with or without any relation to the intervention – raise bad publicity. On the other hand – if the measure is too successful – high interest could be triggered and lead to inflationary application. That would probably undermine the effects where they are urgently needed and induce high unnecessary costs.

Further it was observed that conservative road administrators - after having heard the story – tried to achieve the same results using traditional continuous centre lines or double centre lines. However, these already had been identified as ineffective, which actually led to the development and testing of the elliptic and bar designs.

#### ○ LESSONS LEARNED

We learned that measuring driving speed in curves is a very difficult task, at least using standard radar-based hardware. Choosing the optimum resolution for video recording should be done very carefully having several rounds of testing under practical conditions using the final version of the image processing software.

In terms of crash protection, several other interventions should be considered. Installing sign posts and chevrons is probably not the best to combine with floor markings. First, these signs may distract from floor markings and their sign posts constitute a considerable additional risk to PTW riders. Installation of guardrail underrun protection normally is much more expensive, however, it is said to also avoid crashes by communicating a particular local risk to the riders.

In terms of local design criteria, both bars and ellipses should not be applied too economically. One marking every four to five meters should be considered a minimum, for narrow curves even higher density should be aspired.



Figure 6.185 - a) simple warning sign, b) informative sign

For safety reasons, some of the road administrators insisted on the use of warning signs.

It turned out very practical to use thick white crayon for testing the local layout, test rides with the sheet material provisionally (not yet bonded) placed on the road are a rather risky exercise.

#### ○ COSTS

The installation costs were about 1,000 Euros per curve. The bar design requires about 4 to 5 times the amount of sheet material than the elliptic design. The application can be done within about half an hour for one curve, in case adhesive sheet material is used.

#### ○ CONTACT

Martin Winkelbauer, Kuratorium fuer Verkehrssicherheit, Schleiergasse 18, 1100 Vienna, Austria.  
Tel +43 5 77077 1214. [martin.winkelbauer@kfiv.at](mailto:martin.winkelbauer@kfiv.at)

#### ○ REFERENCES

- [1] Winkelbauer, M.: Riding Left Hand Corners: Facts and Measures. Proceedings of the 14th ifz Motorcycle Conference, Institut für Zweiradsicherheit e.V., Cologne, 2014.
- [2] Winkelbauer, M., Bagar, H.: Kurvenlinien von Motorradfahrern in unübersichtlichen Linkskurven, Ergebnisse einer Videoanalyse. Kuratorium für Verkehrssicherheit, 2013. *(Curve trajectories of motorcycle riders in left-hand curve with short forward visibility; results of a video analysis. This report is in German only.)*
- [3] Winkelbauer, M., Bagar, H., Höher, G., Wollendorfer, C.: Kurvenschneiden bei Motorradfahrern: Bestandsaufnahme und Gegenmaßnahmen. ZVR, S. 74, 137-144. Wien, 2014. *(Cutting curves by motorcycle riders: An inventory and potential measures. This report is in German only.)*
- [4] Winkelbauer, M., Soteropoulos, A., Schneider, F., Tomasch, E.: KfV - Sicher Leben. Band #4. Unfallursachen bei Motorradunfällen. Wien, 2017. <https://trid.trb.org/view/1470263> *(Crash causation in motorcycle crashes. Report in German with comprehensive English summary)*
- [5] Winkelbauer, M., Schneider, F., Strnad, B., Braun, E., Schmied, S.: KfV - Sicher Leben. Band #9. Wirksamkeit von Bodenmarkierungen zur Beeinflussung der Wahl von Kurvenfahrlinien durch Motorradfahrende. Wien, 2017. <https://trid.trb.org/view/1498214> *(How floor-markings influence trajectories of motorcycle riders in left-hand curves, Report in German with comprehensive English summary. The study will be published at the ifz motorcycle conference, Cologne, 2018)*
- [6] GROHAG, 2017:  
[https://www.tourismuspresse.at/presseaussendung/TPT\\_20170718\\_TPT0004/grossglockner-hochalpenstrasse-ellipsen-sorgen-fuer-mehr-motorrad-sicherheit-bild](https://www.tourismuspresse.at/presseaussendung/TPT_20170718_TPT0004/grossglockner-hochalpenstrasse-ellipsen-sorgen-fuer-mehr-motorrad-sicherheit-bild)



### 6.2.2.3. Agglomeration crossing, route 148 in Montebello

#### ○ COUNTRY

Quebec (Canada)

#### ○ IMPLEMENTATION ORGANIZATION

Ministère des Transports, de la Mobilité durable et de l'Électrification des transports du Québec (Ministry of Transport, Sustainable Mobility and Transportation Electrification)

#### ○ SUBJECT

Speed and access management with pedestrians facilities

#### ○ PROJECT DESCRIPTION AND SUMMARY

The village of Montebello has grown in recent years to become one of the most important tourist centers in the region. The road thus assumes an important transit function for travelers to and from Montreal and the National Capital Region.

Following some safety issues perceived by Montebello residents, a round table was created to identify these problems and find solutions. Here is the list of issues raised by this table:

- High speed in entering urban zone,
- Lack of manoeuvring visibility from minor road approach,
- Risk of impact between vehicles in transit and those who are parked in the narrow part of the village,
- Unsafe parking and risky conditions for pedestrians,
- Safety issue for the elderly to cross the R-148 at the intersection of Bonsecours Street,
- Difficulty during entry and exit maneuvers for the Château Montebello,
- Platform of Route 148 insufficient to support existing traffic lanes and parking lots,

Treatments aimed to enhance driver behaviour when approaching and crossing urban area with addition of proper pedestrian infrastructures. Make a clear distinction between rural and urban roads. The construction was done in 2012.

The project consisted of an improvement of the road corridor in Montebello to harmonize traffic, safety and the urban environment in the specific context of the village center of Montebello. To do this, a "rewriting" of the road is planned, either by the development of two entrance gates and by the cutting, with the aid of determined elements, of the road in successive sequences, which will have each their particularities.



Figure 6.186 - Before Project (1)



Figure 6.187 - After Project (1)



Figure 6.188 - Before Project (2)



*Figure 6.189 - After Project (2)*



*Figure 6.190 - Before Project (3)*



*Figure 6.191 - After Project (3)*

○ KEY RESULTS/ACCOMPLISHMENTS

The project contributed to improved parking management and intersections with increased visibility of pedestrians and vehicles on the minor road approach.

- POLICIES

Application of human factor principles allows road users to scan the road environment, reduce their speed and detect potential presence of vulnerable road users.

- BARRIERS/OBSTACLES

The road right-of-way was a constraint that had to be faced. The lack of width of the right of way made impossible the establishment of a bike path in the right-of-way.

- LESSONS LEARNED

Urbanization work has improved the road safety record and has reduced the speeds. Therefore, to reduce speed and to reduce the number of accidents, it is necessary to change the environment for a more urban environment and to regulate access.

- COSTS

Final cost for the works: 2 521 166.00 \$ can

- CONTACT

Lise.Fournier@transports.gouv.qc.ca

- REFERENCES

[1] Transportation Association of Canada, Applied Human Factors in Road Safety Guide, 2013.



#### **6.2.2.4. Rehabilitation of Route 148 to Shawville and Clarendon**

○ COUNTRY

Quebec (Canada)

○ IMPLEMENTATION ORGANIZATION

Ministère des Transports, de la Mobilité durable et de l'Électrification des transports du Québec (Ministry of Transport, Sustainable Mobility and Transportation Electrification)

○ SUBJECT

Speed and access management with pedestrians facilities

○ PROJECT DESCRIPTION AND SUMMARY

The project involves the main access road to downtown Shawville which is located further north. The highway is a adjacent two-lane national highway that is posted at 90 km/hr on both sides of the urbanized area of the municipality of Shawville. The speed displayed in the urban area is 50 km/h. At the eastern entrance of the municipality, the posted speed gradually decreases by 90 km/h, 70 km/h and 50 km/h. At the west entrance, the posted speed goes directly from 90 to 50 km/h. The terrain profile in the project area is relatively flat. The following problems were identified:

- High speed in entering urban zone,
- Lack of proper access management and intersection delimitation,
- Illegal parking and dangerous conditions for pedestrians.

In addition to pavement rehabilitation, the objective of the project was to improve traffic management through the implementation of various developments that will contribute to the urban integration of the road. Specifically, the project includes:

- The urbanization of a part of the road,
- The upgrading private access road to comply with standard.

Treatments aimed to enhance driver behaviour when approaching and crossing urban area with addition of proper pedestrian infrastructures. Make a clear distinction between rural and urban roads. The construction started in 2010 and finished in 2011.

○ KEY RESULTS/ACCOMPLISHMENTS

The project contributed to improved access management and intersection delimitation with increased visibility of pedestrians and vehicles on the minor road approach.

A five years before (2005 - 2009) and after (2012 - 2016) accident analysis resulted in 50 % decrease in crash frequency after project completion. Indeed, there were 16 accidents before and 8 after.



Figure 6.192 - Before project (1)



Figure 6.193 - After project (1)



Figure 6.194 - Before project (2)



Figure 6.195 - After project (2)



*Figure 6.196 - Before project (3)*



*Figure 6.197 - After project (3)*

- POLICIES

Application of human factor principles allows road users to scan the road environment, reduce their speed and detect potential presence of vulnerable road users.

- BARRIERS/OBSTACLES

The main concern is to influence driver behaviour while travelling across the urban area.

- LESSONS LEARNED

Urbanization work has improved the road safety record and has reduced the speeds. Therefore, to reduce speed and to reduce the number of access accidents, it is necessary to change the environment for a more urban environment and to regulate access.

- COSTS

Final cost for the works: 2 044 980.00\$ can

- CONTACT

Lise.Fournier@transports.gouv.qc.ca

- REFERENCES

[1] Transportation Association of Canada, Applied Human Factors in Road Safety Guide, 2013.

### 6.2.2.5. A case study of color wide solid center line

#### ○ COUNTRY

China

#### ○ IMPLEMENTATION ORGANIZATION

Research of Institute of Highway Ministry of Transport of China

#### ○ SUBJECT

The case study covers the topic Man-Road Interaction(HF) and Setting Credible Speed Limits (SCSL) .

#### ○ PROJECT DESCRIPTION AND SUMMARY

It is a two-lane highway with lots of non-motor vehicles and pedestrians connecting the village of Sanren and Haochuan. The speed of vehicles is fast. According to the previous data, from 2014 to 2016, there was at least one fatal accident between car or light truck and the pedestrian. There was a yellow line in the center of the road, as shown in Figure 6.198.



*Figure 6.198 – The yellow center line before implementation*

The project started in December, 2016 and completed in June, 2017. The objective of the project is to reduce the speed of vehicles passing through the villages and ensure pedestrian safety . The measures includes turning the center line to color wide solid line, setting up the street lights and snapshot system to monitor the speeding and violating behaviours.

- Road marking are used to paved roadways to provide guidance and information to drivers and pedestrians. In this case, the road center marking has been formed from a single line to a colour wide solid line, as shown in Figure 6.199. Set up street lights to improve the lighting environment for driving and walking at night. After the laying the colour solid center line, the width of the lane was narrowed from 4 meters to 3.5 meters. The size of the center line is 20x100x20cm, as shown in Figure 6.200. The driver will slow down for a better visual field when driving in narrow lanes.





Figure 6.199 – The new color wide solid line in the middle of the road

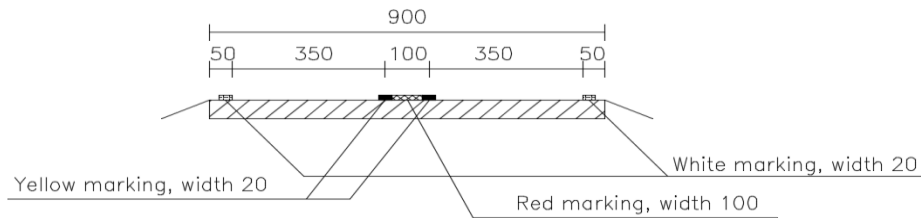
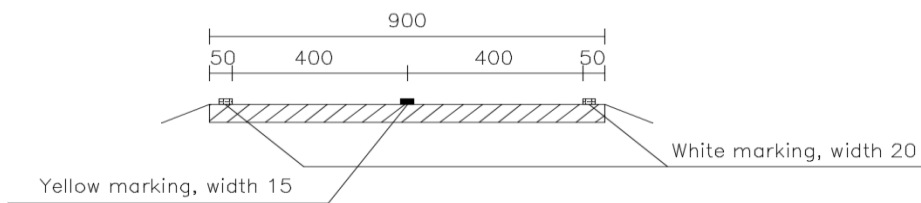

Figure 6.200 - The diagram of the road marking (unit of length: cm)

- Set up a snapshot system to monitor the speeding, overtaking and other violating behaviours, as shown in Figure 6.201.



Figure 6.201 - the camera and road monitoring system

#### ○ KEY RESULTS/ACCOMPLISHMENTS

The colour solid line helps to drive within their own lanes, which increase the right-side safety space and reduces the conflicts of the vehicles driving in the opposite direction. Most the drivers tend to go slower and respect the posted speed limit when they are facing the new center line. The additional monitoring facilities perform well. A small number of vehicles overtook on the road, few cars crossed the center line. The velocity of each type of vehicles was reduced to less than 50km/h. During the observation, there is almost no driving onto or across the center line, except for few overtaking vehicles.

#### ○ LESSONS LEARNED

After the center line is marked with a colour solid line, the vehicles are running in their own lanes. It will increase the right-side safety space and reduces the traffic conflicts of the vehicles driving in the opposite direction.

#### ○ COSTS

The price of the colour solid line is RMB150 yuan/m<sup>2</sup>. The total length of the marking is about 500 meters, it starts at the beginning of the village and finishes at the end of the village. The total cost of marking is RMB60000 yuan.

#### ○ CONTACT

Dr. Chengcheng TANG: 973939419@qq.com

### 6.2.2.6. *Wrong way driving on motorway E18 Halikko ramp, Salo*

#### ○ COUNTRY

Finland

#### ○ IMPLEMENTATION ORGANIZATION

Centres for Economic Development, Transport and the Environment

#### ○ SUBJECT

Wrong-way driving on motorways or on other dual carriageways is a relatively rare incident type that usually leads to very severe accidents.

Five (28 %) of Finland's 18 wrong-way accidents were caused by drivers, who had chosen the wrong ramp. Accidents resulting from selecting the wrong ramp or from intentional u-turns were fewer in Finland than in other countries. Wrong-ramp accidents were typical to younger drivers, which was also the case in other countries where the topic has been studied. Finnish accident data revealed that in Finland one significant cause behind wrong-way accidents is turning into a wrong direction at the end of the entry ramp. In other countries no such accidents were mentioned. The full diamond intersection was the most problematic intersection type regarding wrong-way accidents.

In Finland, prevention of wrong-way driving can be improved by intensifying the use of "no entry" signs and pavement arrows. The use of islands and roundabouts in intersections should be developed.

#### ○ PROJECT DESCRIPTION AND SUMMARY

The aim of the project is to reduce or prevent wrong-way driving on motorway ramps by using small and cost-effective improvements.

The project included the following phases:

- conducting a traffic safety inspection, which included an accident analysis and a proposal for measures for improvements
- drawing up a construction plan for the implementation of improvements put forward in the traffic safety inspection
- implementing the improvements included in the construction plan - i.e. construction

#### Traffic safety inspection

The time of the accident and the prevailing conditions do not appear to have a significant bearing on the accidents that have taken place. The accidents take place almost equally in both the summer and winter months. Of the events 61% took place between 8:00 and 18:00 and 56% took place in daylight under clear or partly cloudy skies. Only 11% of accidents took place in poor conditions (twilight or rain). Seventeen percent of the accidents took place in the hours of darkness when conditions were otherwise good (cloudy and dry). The speed limit at the scene of the accidents on the motorway was 100 -120 km/h.

The most common known reason for driving in the wrong direction involved driving the wrong way on the exit ramp. The second most common reason was turning in the wrong direction at the lower

end of the entry ramp and making a deliberate u-turn. The most common reason for making a deliberate u-turn was driving past an intersection and wanting to get back to it.

In seven cases the wrong carriageway was reached by driving in the wrong direction on the exit ramp. In these situations there were straight ramps at the interchange and loop ramps next to each other on the intersecting roads. In three accidents the driver had gone in the wrong direction by turning left at the end of the entry ramp. In these cases there were straight ramps in all of the interchanges.

Of the types of interchange a diamond interchange with straight ramps seems to be the most problematic type of exchange with respect to driving in the wrong direction. The problem with the diamond exchange involves ramp intersections where the direction of a one-way ramp is difficult to see. The only signals indicating the direction are road markings and traffic signs, as the geometric shape of the intersection does not guide the driver to the right ramp. The situation is especially difficult when it is hard to see the motorway from the intersecting road. In an urban environment there are many places that require observation, which may increase the risk of entering the carriageway going in the wrong direction.

On the basis of accident analysis the following general characteristics can be identified in accidents involving driving in the wrong direction on a ramp:

- - driving in the wrong direction is relatively rare,
- - accidents often have serious consequences (high speed, surprise),
- - the most common type of collision is a head-on collision,
- - alcohol and a lapse in concentration are among the most common causes of accidents,
- - the proportion of elderly drivers in cases of accidents is great, and
- - most of the accidents occur in the hours of daylight under good driving conditions

In Finland repeated "no entry" signs have been placed at distances of about 50 metres from the beginnings of the exit ramps. Visibility of the existing signs has also been checked. Attempts have been made to solve the problems related to diamond interchanges by building roundabouts at the ends of ramps. Building roundabouts has eliminated accidents caused by wrong-way driving. One remedy that has also been used has been to narrow the end of the exit ramp so that it would not look like a two-way ramp.

#### Construction plan

The purpose of this project was to find cost-effective methods that are easy to implement that would prevent driving in the wrong direction from a motorway ramp on National road 1 / E 18 between Turku and Muurla. The Halikko ramp in Salo was taken under especially close examination.

The E 18 motorway between Paimio and Muurala was opened to traffic in 2003. The entrance and exit ramps on the lower levels of grade-separated interchanges were designed according to guidelines that were in force at the time of construction. The interchange areas are wide and nearly in their original form.



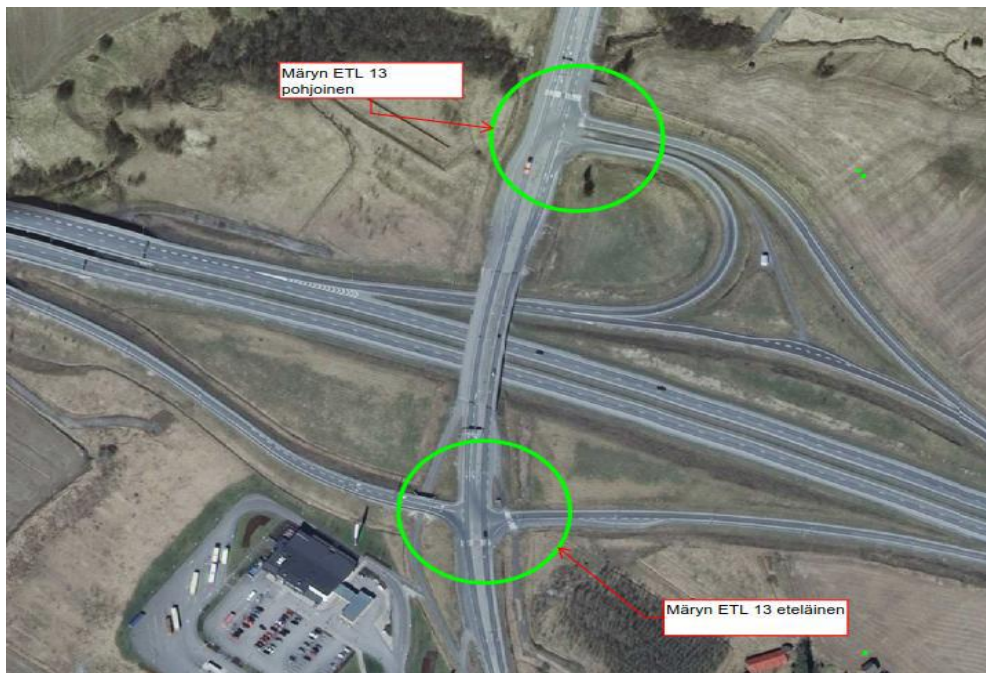

Figure 6.202 - The southern ramp of the Halikko grade-separated interchange. The picture is copied from the construction plan vicinity map: Märy grade-separated interchange, north; Märy grade-separated interchange, south

More expensive procedures, such as:

- changing the interchange angle and using better cross-overbends
- the construction of a roundabout at the end of the ramp,
- building a turnaround for those who have driven the wrong way on a ramp,
- using physical obstacles, such as gates that rise mechanically, or spikes

were not included among the methods used in this project. They are expensive (> €50,000) measures and their implementation would require separate funding. In the future these measures can be implemented as part of an overall improvement project for the motorway in question.

In phase 2 a construction plan for improvement measures was drafted, in which the following factors of a good and clear traffic environment were examined:

- guideposts and road markings
- shaping the ends of the ramps with various types of island solutions to make driving in the wrong direction as difficult as possible
- utilisation of telematics

It is not possible to completely prevent driving in the wrong direction at the Halikko grade-separated interchange using low-cost structural methods such as shaping the mouth of the ramp or shaping the islands.

The interchange has channelization. The interchange does not have traffic lights. The ramp that rises for traffic from the direction of Turku has four traffic signs indicating that the driver is going the wrong way - two near the interchange and two at a distance of about 65 metres from the interchange warning drivers not to go in the wrong direction. Highway 224 has no turning signs for drivers coming from the south and the north to prevent turning onto the wrong ramp.

Implementing the measures of the improvement plan - i.e. construction.

The following improvement measures were carried out in the construction project:

- The central island in the interchange area was extended by 12.5 metres. The measure makes it more difficult to make a wrong turn onto the ramp rising from the direction of Turku.
- The traffic island sign (no. 417) was moved to a new location in proportion with the 12.5-metre extension of the central island.
- The portal sign on the left side of the ramp coming from the direction of Turku was switched
- Arrows were painted on the left lane of the ramp for traffic from Turku for those driving straight ahead and for those turning left
- a road marking to yield the right of way was repainted
- two radar indicators were installed on the ramp in the current portals and one indicator after the portal. The radar detects those driving in the wrong direction. Driving in the normal direction on the ramp does not cause the radar to react. The radar indicators at the portals send information to traffic lights placed on both sides of the ramp, which light up and warn a driver going in the wrong direction. The lights used are single red traffic lights. A third radar indicator has been installed on the traffic light pole on the ramp to detect a vehicle that continues in the wrong direction in spite of the red traffic light. Information on the sighting can be sent to the traffic management centre, after which the centre takes the necessary measures.

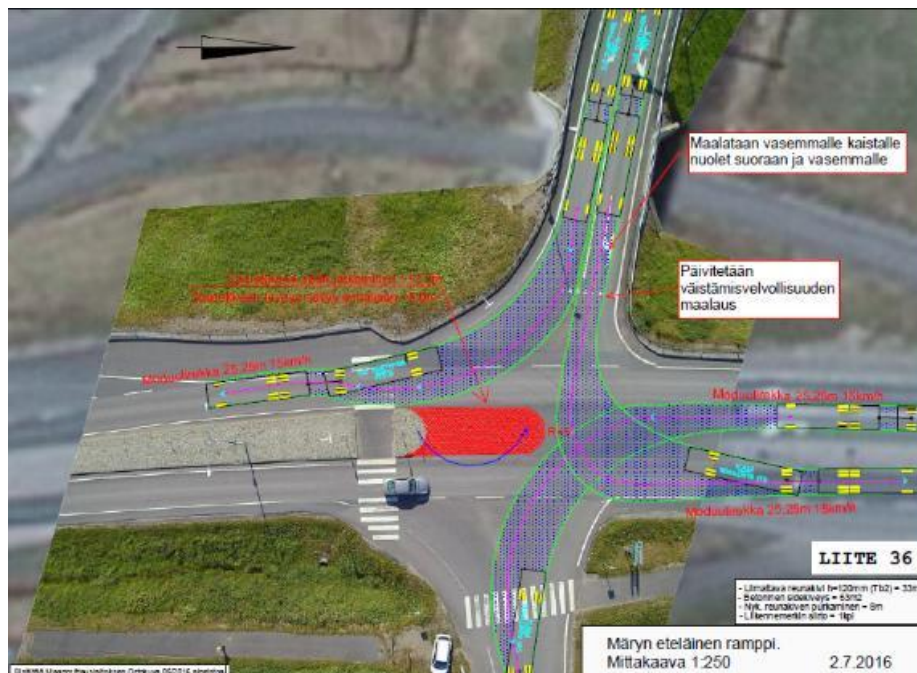

Figure 6.203 - Taken from the plan map of the south ramp at Halikko: Paint arrows on left lane straight and to the left; Repaint road marking to yield right of way; Extend end of central island ~ 12.5 m; Width of central island unchanged ~ 5.0 m; Module truck 25.25 m. 15 km/h; Curbstone  $h=120$  mm (Tb2) = 33m; Concrete bond stone = 63m<sup>2</sup>; Dismantling existing curbstone = 8 m; Moving 1 traffic sign; Märy southern ramp; Scale 1:250 2 July 2016

### ○ KEY RESULTS/ACCOMPLISHMENTS

Ways to prevent accidents caused by wrong-way driving were carried out in 2017. Measures involving road signs, guideposts, and road markings focused on clarity of routing, visibility and repetition of "no entry" signs, as well as the visibility and clarity of one-way arrows, stop lines, and lane indicators. Interchanges were designed by extending central islands to prevent turning onto a ramp going in the wrong direction, or at least to make it as difficult as possible.



*Figure 6.204 - The most significant system developed in the new project was a warning light that turns red if a driver is about to take a motorway ramp in the wrong direction. Photo: Jaakko Klang*

The warning lights have worked very well. With the exception of a few malfunctions, there have been no cases in which drivers have driven in the wrong direction on an experimental ramp without turning around after seeing the red light. According to several eyewitness reports, two cars started to go in the wrong direction on the Halikko ramp in 2017, but they turned around no later than when the red warning lights flashed. After the construction and installation work was completed, 27 observation visits were made to the location under study, and the equipment worked each time.

No new accidents have occurred since 2016.

### ○ POLICIES

We recommend traffic safety inspections for all old motorways so that problem locations with respect to driving in the wrong direction on a ramp, for example, might be found.

The most important new system is a traffic light that turns red when a driver enters a motorway ramp in the wrong direction. The experiment should be continued and expanded to all of Finland's problem ramps where driving in the wrong direction has been observed.

### ○ BARRIERS/OBSTACLES

The most significant obstacle to implementing such projects is the lack of sufficient funding.

### ○ LESSONS LEARNED

With small and cost-effective measures it is possible to significantly improve traffic safety for grade-separated interchanges and to reduce and prevent driving in the wrong direction on a ramp. The project can be implemented quickly - within a year of the completion of a traffic safety inspection.

- COSTS

Improving the Halikko ramp interchange through minor measures cost about € 25,000.

- CONTACT

Jaakko Klang, [Jaakko.klang@ely-keskus.fi](mailto:Jaakko.klang@ely-keskus.fi)

- REFERENCES

- [1] AASHTO (1990). A Policy on Geometric Design of Highways and Streets. American Association of State Highway Officials. 1044 pages.
- [2] AASHTO (1984). A Policy on Geometric Design of Highways and Streets. American Association of State Highway Officials. 1087 pages.
- [3] AASHTO (1965). A Policy on Geometric Design of Rural Highways. American Association of State Highway Officials. 650 pages.
- [4] Blokpoel, A. & de Niet, M. (2000). Spookrijders en frontale botsingen op autosnelwegen.
- [5] Summary: Wrong-way drivers and head-on collisions on Motorways; number and development of their threat to road safety, in the period up to 1998. SWOV, rapport 2000/16. 48 pages.
- [6] Brevoord, G. A. (1998). Spookrijden. Ministerie van Verkeer en Waterstaat. 152 pages.
- [7] Copelan, Joyce (1989). Prevention of wrong-way accidents on freeways. California department of transportation. 95 pages.
- [8] de Niet, M. & Blokpoel, A. (2000). Tegen de stroom in. Summary: Heading in the wrong direction; Descriptive research on wrong-way driving on Dutch motorways: background, causes, liability and measures. SWOV, rapport 2000/6. 86 pages.
- [9] Eck, Ronald & Winn, Gary (2001). Olde driver's perceptions of problems at unsignalized intersections on divided highways. TRB 2002 Annual meeting CD-ROM. 21 pages.
- [10] Gunnarsson, Olof (2000). Felkörning på motorvägar ("spökkörning"). Chalmers tekniska högskola, rapport 2000:1. 16 pages.
- [11] Harwood, Joe (1997). Wrong-way drivers take a deadly path .<http://www.tricityherald.com/news/oldnews/1997/0413.html#anchor596414> .
- [12] Itarda (2002). Occurrence of wrong-way accidents. Institute for Traffic Accident Research and Data Analysis. <http://www.itarda.or.jp/english/info36/next01.html>
- [13] Moler, Steve (2002). Stop. You're going the wrong way!. Public Roads, September/October 2002. <http://www.tfhr.gov/pubrds/02sep/06.htm>
- [14] Robatsch, Klaus & Hagspiel, Edgar (2001). Geisterfahrer - Ursachen von Falschfahrten und entsprechende Massnahmen. 21 pages.
- [15] RVS (1990). Richtlinien und Vorschriften für den Straßenbau 5.28, Maßnahmen zur Verhinderung von Fehlfahrten bei richtungsgetrennten Fahrbahnen. Forschungsgesellschaft für das Verkehrs- und Straßenwesen im ÖiAV.



- [16] TAC (Transportation Association of Canada) 1999. Geometric Design Guide for Canadian Roads, Part 2. September 1999. The Highway Safety Desk Book. 283 pages  
[www.nhtsa.dot.gov/people/injury/enforce/pub/deskbk.pdf](http://www.nhtsa.dot.gov/people/injury/enforce/pub/deskbk.pdf)
- [17] Tiehallinto 2001. Tasoliittymät. Suunnitteluvaiheen ohjaus. Tiehallinto, Helsinki 2001.
- [18] Vägverket 1994. Värutformning 94 version S-2 (VU 94 S-2). <http://www3.vv.se/vu94s2/>

### 6.2.2.7. Wrong way driving on motorway E18 Pappila ramp, Salo

#### ○ COUNTRY

Finland

#### ○ IMPLEMENTATION ORGANIZATION

Centres for Economic Development, Transport and the Environment

#### ○ SUBJECT

Wrong-way driving on motorways or on other dual carriageways is a relatively rare incident type that usually leads to very severe accidents.

Five (28 %) of Finland's 18 wrong-way accidents were caused by drivers, who had chosen the wrong ramp. Accidents resulting from selecting the wrong ramp or from intentional u-turns were fewer in Finland than in other countries. Wrong-ramp accidents were typical to younger drivers, which was also the case in other countries where the topic has been studied. Finnish accident data revealed that in Finland one significant cause behind wrong-way accidents is turning into a wrong direction at the end of the entry ramp. In other countries no such accidents were mentioned. The full diamond intersection was the most problematic intersection type regarding wrong-way accidents. In Finland, prevention of wrong-way driving can be improved by intensifying the use of "no entry" signs and pavement arrows. The use of islands and roundabouts in intersections should be developed.

#### ○ PROJECT DESCRIPTION AND SUMMARY

The aim of the project is to reduce or prevent wrong-way driving on motorway ramps by using small and cost-effective improvements.

The project included the following phases:

- conducting a traffic safety inspection, which included an accident analysis and a proposal for measures for improvements
- drawing up a construction plan for the implementation of improvements put forward in the traffic safety inspection
- Implementing the improvements included in the construction plan - i.e. construction

#### Traffic safety inspection

The time of the accident and the prevailing conditions do not appear to have a significant bearing on the accidents that have taken place. The accidents take place almost equally in both the summer and winter months. Of the events 61% took place between 8:00 and 18:00 and 56% took place in daylight under clear or partly cloudy skies. Only 11% of accidents took place in poor conditions (twilight or rain). Seventeen percent of the accidents took place in the hours of darkness when conditions were otherwise good (cloudy and dry). The speed limit at the scene of the accidents on the motorway was 100 -120 km/h.

The most common known reason for driving in the wrong direction involved driving the wrong way on the exit ramp. The second most common reason was turning in the wrong direction at the lower end of the entry ramp and making a deliberate u-turn. The most common reason for making a deliberate u-turn was driving past an intersection and wanting to get back to it.

In seven cases the wrong carriageway was reached by driving in the wrong direction on the exit ramp. In these situations there were straight ramps at the interchange and loop ramps next to each other on the intersecting roads. In three accidents the driver had gone in the wrong direction by turning left at the end of the entry ramp. In these cases there were straight ramps in all of the interchanges.

Of the types of interchange a diamond interchange with straight ramps seems to be the most problematic type of exchange with respect to driving in the wrong direction. The problem with the diamond exchange involves ramp intersections where the direction of a one-way ramp is difficult to see. The only signals indicating the direction are road markings and traffic signs, as the geometric shape of the intersection does not guide the driver to the right ramp. The situation is especially difficult when it is hard to see the motorway from the intersecting road. In an urban environment there are many places that require observation, which may increase the risk of entering the carriageway going in the wrong direction.

On the basis of accident analysis the following general characteristics can be identified in accidents involving driving in the wrong direction on a ramp:

- driving in the wrong direction is relatively rare,
  - - accidents often have serious consequences (high speed, surprise),
  - - the most common type of collision is a head-on collision,
  - - alcohol and a lapse in concentration are among the most common causes of accidents,
  - - the proportion of elderly drivers in cases of accidents is great, and
  - - most of the accidents occur in the hours of daylight under good driving conditions

In Finland repeated "no entry" signs have been placed at distances of about 50 metres from the beginnings of the exit ramps. Visibility of the existing signs has also been checked. Attempts have been made to solve the problems related to diamond interchanges by building roundabouts at the ends of ramps. Building roundabouts has eliminated accidents caused by wrong-way driving. One remedy that has also been used has been to narrow the end of the exit ramp so that it would not look like a two-way ramp.

#### Construction plan

The purpose of this project was to find cost-effective methods that are easy to implement that would prevent driving in the wrong direction from a motorway ramp on National road 1 / E 18 between Turku and Muurla. The Pappila ramp in Salo was taken under especially close examination.

The E 18 motorway between Paimio and Muurla was opened to traffic in 2003. The entrance and exit ramps on the lower levels of grade-separated interchanges were designed according to guidelines that were in force at the time of construction. The interchange areas are wide and nearly in their original form.



Figure 6.205 - The northern ramp of the Pappila grade-separated interchange. The picture is copied from the construction plan vicinity map: Pappila grade-separated interchange 15, north; Pappila grade-separated interchange 15, south; Pappila grade-separated interchange (ETL 15); Vicinity map

More expensive procedures, such as

- changing the interchange angle and using better cross-overbends
- the construction of a roundabout at the end of the ramp,
- building a turnaround for those who have driven the wrong way on a ramp,
- using physical obstacles, such as gates that rise mechanically, or spikes were not included among the methods used in this project. They are expensive (> €50,000) measures and their implementation would require separate funding. In the future these measures can be implemented as part of an overall improvement project for the motorway in question.

In phase 2 a construction plan for improvement measures was drafted, in which the following factors of a good and clear traffic environment were examined:

- guideposts and road markings
- shaping the ends of the ramps with various types of island solutions to make driving in the wrong direction as difficult as possible
- utilisation of telematics



It is not possible to completely prevent driving in the wrong direction at the Pappila grade-separated interchange using low-cost structural methods such as shaping the mouth of the ramp or shaping the islands.

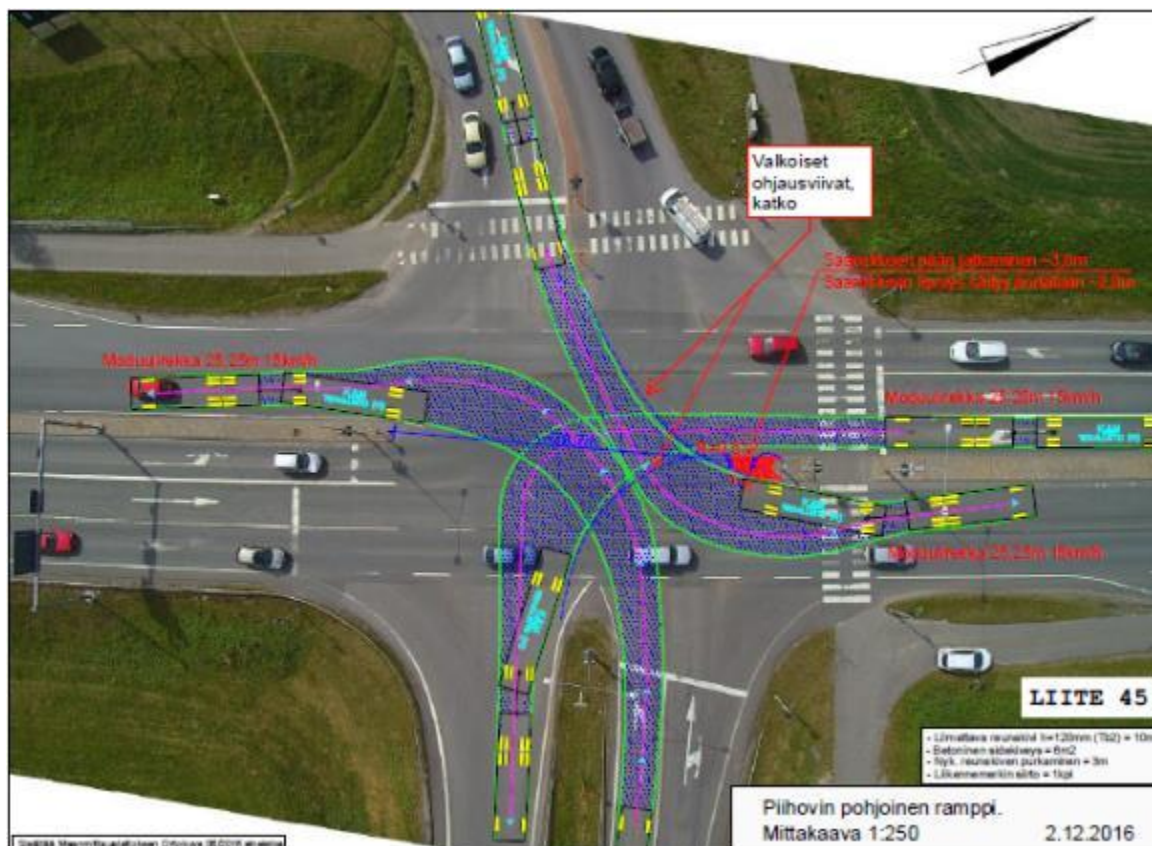

Figure 6.206 - Taken from the plan map of the north ramp at Pappila; White stripes, break; Extend end of central island ~ 3.6 m; Width of central island unchanged ~ 2.0m; Module truck 25.25 m. 15 km/h; Module truck 25.25 m. 15 km/h; Module truck 25.25 m. 15 km/h; Curbstone  $h=120$  mm (Tv2) = 33m; Concrete bond stone = 6m<sup>2</sup>; Dismantling existing curbstone = 3 m; Moving 1 traffic sign; Piihovi northern ramp; Scale 1:250; 2 December, 2016

The interchange has chanelisation and traffic lights. The ramp that rises from the direction of Helsinki has four traffic signs indicating that the driver is going the wrong way - two near the interchange and two at a distance of about 35 metres from the interchange warning drivers not to go in the wrong direction.

Implementing the measures of the improvement plan - i.e. construction

The following improvement measures were carried out in the construction project:

- The central island in the interchange area was extended by 3.6 metres. The measure makes it more difficult to make a wrong turn onto the ramp rising from the direction of Turku.
- The traffic island sign (no. 417) was moved to a new location in proportion with the 6.5-metre extension of the central island.
- Arrows were painted on the left lane of the ramp for traffic from Helsinki.
- For those turning off Trunk Road 52 from the north white stripes were painted to make it easier to choose a lane

- two radar indicators were installed on the ramp in the current portals and one indicator after the portal. The radar detects those driving in the wrong direction. Driving in the normal direction on the ramp does not cause the radar to react. The radar indicators at the portals send information to traffic lights placed on both sides of the ramp, which light up and warn a driver going in the wrong direction. The lights used are single red traffic lights. A third radar indicator has been installed on the traffic light pole on the ramp to detect a vehicle that continues in the wrong direction in spite of the red traffic light. Information on the sighting can be sent to the traffic management centre, after which the centre takes the necessary measures.

#### ○ KEY RESULTS/ACCOMPLISHMENTS

Ways to prevent accidents caused by wrong-way driving were carried out in 2017. Measures involving road signs, guideposts, and road markings focused on clarity of routing, visibility and repetition of "no entry" signs, as well as the visibility and clarity of one-way arrows, stop lines, and lane indicators. Interchanges were designed by extending central islands to prevent turning onto a ramp going in the wrong direction, or at least to make it as difficult as possible.



*Figure 6.207 - The most significant system developed in the new project were warning lights that turns red if a driver is about to take a motorway ramp in the wrong direction. Photo: Jaakko Klang*

The warning lights have worked very well. With the exception of a few malfunctions, there have been no cases in which drivers have driven in the wrong direction on an experimental ramp without turning around after seeing the red light. According to several eyewitness reports, two cars started to go in the wrong direction on the Halikko ramp in 2017, but they turned around no later than when the red warning lights flashed. After the construction and installation work was completed, 27 observation visits were made to the location under study, and the equipment worked each time.

No new accidents have occurred since 2016.

#### ○ POLICIES

We recommend traffic safety inspections for all old motorways so that problem locations with respect to driving in the wrong direction on a ramp, for example, might be found.

The most important new system is a traffic light that turns red when a driver enters a motorway ramp in the wrong direction. The experiment should be continued and expanded to all of Finland's problem ramps where driving in the wrong direction has been observed.

- BARRIERS/OBSTACLES

The most significant obstacle to implementing such projects is the lack of sufficient funding.

- LESSONS LEARNED

With small and cost-effective measures, it is possible to significantly improve traffic safety for grade-separated interchanges and to reduce and prevent driving in the wrong direction on a ramp. The project can be implemented quickly - within a year of the completion of a traffic safety inspection.

- COSTS

Improving the Pappila ramp interchange through minor measures cost about € 28,000.

- CONTACT

Jaakko Klang, [Jaakko.klang@ely-keskus.fi](mailto:Jaakko.klang@ely-keskus.fi)

- REFERENCES

- [1] AASHTO (1990). A Policy on Geometric Design of Highways and Streets. American Association of State Highway Officials. 1044 pages.
- [2] AASHTO (1984). A Policy on Geometric Design of Highways and Streets. American Association of State Highway Officials. 1087 pages.
- [3] AASHTO (1965). A Policy on Geometric Design of Rural Highways. American Association of State Highway Officials. 650 pages.
- [4] Blokpoel, A. & de Niet, M. (2000). Spookrijders en frontale botsingen op autosnelwegen.
- [5] Summary: Wrong-way drivers and head-on collisions on Motorways; number and development of their threat to road safety, in the period up to 1998. SWOV, rapport 2000/16. 48 pages.
- [6] Brevoord, G. A. (1998). Spookrijden. Ministerie van Verkeer en Waterstaat. 152 pages.
- [7] Copelan, Joyce (1989). Prevention of wrong-way accidents on freeways. California department of transportation. 95 pages.
- [8] de Niet, M. & Blokpoel, A. (2000). Tegen de stroom in. Summary: Heading in the wrong direction; Descriptive research on wrong-way driving on Dutch motorways: background, causes, liability and measures. SWOV, rapport 2000/6. 86 pages.
- [9] Eck, Ronald & Winn, Gary (2001). Olde driver's perceptions of problems at unsignalized intersections on divided highways. TRB 2002 Annual meeting CD-ROM. 21 pages.
- [10] Gunnarsson, Olof (2000). Felkörning på motorvägar ("spökkörning"). Chalmers tekniska högskola, rapport 2000:1. 16 pages.
- [11] Harwood, Joe (1997). Wrong-way drivers take a deadly path. <http://www.tricityherald.com/news/oldnews/1997/0413.html#anchor596414>.
- [12] Itarda (2002). Occurrence of wrong-way accidents. Institute for Traffic Accident Research and Data Analysis. <http://www.itarda.or.jp/english/info36/next01.html>
- [13] Moler, Steve (2002). Stop. You're going the wrong way!. Public Roads, September/October 2002. <http://www.tfhr.gov/pubrds/02sep/06.htm>

- [14]Robatsch, Klaus & Hagspiel, Edgar (2001). Geisterfahrer - Ursachen von Falschfahrten und entsprechende Massnahmen. 21 pages.
- [15]RVS (1990). Richtlinien und Vorschriften für den Straßenbau 5.28, Maßnahmen zur Verhinderung von Fehlfahrten bei richtungsgetrenten Fahrbahnen. Forschungsgesellschaft für das Verkehrs- und Straßenwesen im ÖiAV.
- [16]TAC (Transportation Association of Canada) 1999. Geometric Design Guide for Canadian Roads, Part 2. September 1999. The Highway Safety Desk Book. 283 pages  
[www.nhtsa.dot.gov/people/injury/enforce/pub/deskbk.pdf](http://www.nhtsa.dot.gov/people/injury/enforce/pub/deskbk.pdf)
- [17]Tiehallinto 2001. Tasoliittymät. Suunnitteluvaiheen ohjaus. Tiehallinto, Helsinki 2001.
- [18]Vägverket 1994. Värutformning 94 version S-2 (VU 94 S-2). <http://www3.vv.se/vu94s2/>



### 6.2.2.8. Evaluation of audio-tactile systems to prevent run-off-roads: in situ study

#### ○ COUNTRY

France

#### ○ IMPLEMENTATION ORGANIZATION

Cerema Normandy Center, based in Rouen (France)

#### ○ SUBJECT

In Europe, single-vehicle run-off-road and head on collisions (which relate to trajectory control) represent 32% of fatal (ERSO, 2015) and inappropriate lateral positioning is one of the primary factors leading to crashes (RISER, 2006). In France, 40% of road fatalities occur in single-vehicle accidents without a third party. A mean to prevent run-off-road crashes is the implementation directly on the road of audio-tactile systems such as rumble strips or raised markings. In France, rumble strips are not regulatory whatever the road type, they can be implemented only in experimental frames.

In 2010, the French project “RoadSense” (co-funded by the National Agency for Research) has developed and evaluated audio-tactile systems to prevent involuntary traffic lane departure. Implementation on undivided rural roads was performed with regard to major issues of run-off-road and head on collisions on these roads. Implementation on divided highways (shoulders, motorways are excluded) aimed at preventing encroachments. In this research project, the development concerned sound and vibration characterizations and experiments on test tracks, driving simulator and in situ. This project was based on a transversal approach which involved human and technical sciences. The present case study focused on the in situ evaluation. Three situations were studied following before/after method:

- on undivided rural roads: the raised rumble strips were implemented on the pavement and adjacent to the road markings. For the straight sections, they were along the left side of shoulder markings. On the bends, they were implemented from either side of centreline marking.

The milled rumble strips were shoulder rumble stripEs (i.e., marking is placed over the rumble strips).

- on divided highways: the raised rumble strips were implemented on the dotted road marking.

#### ○ PROJECT DESCRIPTION AND SUMMARY

In 2010, the French project “RoadSense” (co-funded by the National Agency for Research) has developed and evaluated audio-tactile systems implemented on road to prevent involuntary traffic lane departure. The rumble strips are effective safety devices with regard to the issues of run-off roads and head-on collisions. In France, these are not regulatory, they can be implemented only in experimental frames. In this project there were: implication of human and technical sciences; sound and vibration characterisations following a research and development procedure with laboratory, test track and in situ evaluations. Implementation on the undivided rural roads was performed with regard to major issues of run-off-road and head on collisions on these roads. Implementation on divided highways (shoulders, motorways are excluded) aimed at preventing encroachment on shoulders by HGVs.

The present case study focused on the in situ evaluation. Three situations were studied following before/after method:

- - on undivided rural roads: the raised rumble strips were implemented on the pavement and adjacent to the road markings. For the straight sections, they were along the left side of shoulder markings. On the bends, they were implemented from either side of centreline marking.
- The milled rumble strips were shoulder rumble stripEs (i.e., marking is placed over the rumble strips).
- - on divided highways: the raised rumble strips were implemented on the dotted road marking.

The raised rumble strips have required a specific design development, which results of:

- - the aim of using only the alert function (the visual guidance function was excluded) and to be freed from road marking constraints on the roads without edgeline,
- - specific pattern which has been defined from laboratory experiments and test tracks,
- - in France, on undivided rural roads the dotted road markings prevail.

Consequently, on the undivided rural road sections, the raised rumble strips have been implemented on pavement along the road markings and thus these were colour pavement.

Furthermore, because of these specific raised rumble strips (i.e., pavement colour and/or pattern) and the rumble strips are not regulatory road equipment in France, the road managers involved in project have to adapt as best as possible their implementation procedure and to accept to engrave the pavement.



Figure 6.208 - Pictures of implementation of the raised or milled rumble strips for the in situ evaluation. Picture at left: view of the implementation of raised rumble strips for the divided highway in Côte d'Armor (Department 22, France). Pictures at centre: views of the implementation

of raised rumble strips of colour pavement in Haute-Garonne (Department 31, France). Picture at right: views of implementation of milled rumble strips in Seine-Maritime (Department, 76, France).



Figure 6.209 - Pictures of implemented raised or milled rumble strips for the in situ evaluation. Picture at left: view of the implemented raised rumble strips on the bend for the divided highway on the dotted road marking of shoulder, in Côte d'Armor (Department 22, France). Pictures at centre: views of the implemented raised rumble strips of colour pavement, at upper, raised rumble strips were implemented from either side of centreline marking on the dotted road marking. At lower, they were along the left side of shoulder markings in Haute-Garonne (Department 31, France). Picture at right: views of the milled rumble strips were shoulder rumble stripEs (i.e., marking is placed over the rumble strips) in Seine-Maritime (Department, 76, France).

#### ○ KEY RESULTS/ACCOMPLISHMENTS

The results of the in situ evaluation showed that:

- on undivided rural road sections after implementation of raised rumble strips of pavement colour on pavement (i.e., on left side of shoulder road marking or from either side of centreline marking): the drivers were more centred on their lane, there are not unsuitable manoeuvres or changes in practiced speeds. For the centreline implementation, the drivers were significantly further to the right from the road centre.
- on curve section of divided highway: any unsuitable manoeuvres were observed. There are not impact on the lateral position of heavy goods vehicles or passenger cars.

Note that since the implementation, any crashes are occurred on the undivided rural road sections concerned.

#### ○ COSTS

Low cost

#### ○ CONTACTS

[Florence.rosey@cerema.fr](mailto:Florence.rosey@cerema.fr)

#### ○ REFERENCES

- [1] ERSO (European Road Safety Observatory), 2015. Traffic Safety Basic Facts on Single Vehicle Accidents. European Commission, Directorate General for Transport June.

- [2] RISER, 2006. European Best Practice for Roadside Design: Guidelines for Roadside Infrastructure on New and Existing Roads. RISER Deliverable D06. Göteborg, Chalmers University of Technology, 2006.



### ***6.2.2.9. Evaluation of audio-tactile systems to prevent run-off-roads: driving simulator study***

#### ○ COUNTRY

France

#### ○ IMPLEMENTATION ORGANIZATION

Cerema Normandy Center, based in Rouen (France)

#### ○ SUBJECT

In Europe, single-vehicle run-off-road and head on collisions (which relate to trajectory control) represent 32% of fatal (ERSO, 2015) and inappropriate lateral positioning is one of the primary factors leading to crashes (RISER, 2006). In France, 40% of road fatalities occur in single-vehicle accidents without a third party. A mean to prevent run-off-road crashes is the implementation directly on the road of audio-tactile systems such as rumble strips or raised markings. In France, rumble strips are not regulatory whatever the road type, they can be implemented only in experimental frames.

In 2010, the French project “RoadSense” (co-funded by the National Agency for Research) has developed and evaluated audio-tactile systems to prevent involuntary traffic lane departure. Implementation on undivided rural roads was performed with regard to major issues of run-off-road and head on collisions on these roads. Implementation on divided highways (shoulders, motorways are excluded) aimed at preventing encroachments. In this research project, the development concerned sound and vibration characterizations and experiments on test tracks, driving simulator and in situ. This project was based on a transversal approach which involved human and technical sciences. The present case study focused on the driving simulator evaluation. It has been performed in order to assess the a priori acceptability level of this type of systems, since in France, they are not regulatory. In context of undivided rural roads, three audio-tactile systems have been evaluated according to two implementations. The three audio-tactile systems were: spots and “barrettes” (rolled) (i.e., French profiled road markings) and milled rumble strips. The two implementations were:

- both on centreline and on shoulders for the Rolled and milled rumble strips. The rolled rumble strips were on the pavement along the left side of dotted shoulder markings and thus they were of colour pavement. The milled rumble strips were shoulder rumble strips (i.e., marking is placed over the rumble strips),

- only on centreline for Rolled and milled rumble strips. In this configuration rolled and milled rumble strips were implemented in continuous. The rolled rumble strips were white on dotted marking and colour pavement in the spaces,

- spots have been always implemented on dotted shoulder road marking with rolled or milled center rumble strips,

In this driving simulator experiment, 58 participants drove on fixed-base DS and in three driving situations: a reference situation without traffic, overtaking two powered wheels and a distraction task with SMS writing (word “juin”).

An acceptability questionnaire has been completed after the driving simulation in order to assess the a priori acceptability level of the audio-tactile systems met with regard to comfort and safety.

#### ○ PROJECT DESCRIPTION AND SUMMARY

In 2010, the French project “RoadSense” (co-funded by the National Agency for Research) has developed and evaluated audio-tactile systems implemented on road to prevent involuntary traffic lane departure. The rumble strips are effective safety devices with regard to the issues of run-off roads and head-on collisions. In France, these are not regulatory, they can be implemented only in experimental frames. In this project there were: implication of human and technical sciences; sound and vibration characterisations following a research and development procedure with laboratory, test track and in situ evaluations. This project was based on a transversal approach which involved human and technical sciences. The present case study focused on the driving simulator evaluation. It has been performed in order to assess the a priori acceptability level of this type of systems, since in France, they are not regulatory. In context of undivided rural roads, three audio-tactile systems have been evaluated according to two implementations. The three audio-tactile systems were: spots and “barrettes” (rolled) (i.e., French profiled road markings) and milled rumble strips. The two implementations were:

- both on centreline and on shoulders for the Rolled and milled rumble strips. The rolled rumble strips were on the pavement along the left side of dotted shoulder markings and thus they were of colour pavement. The milled rumble strips were shoulder rumble strips (i.e., marking is placed over the rumble strips),
- only on centreline for Rolled and milled rumble strips. In this configuration rolled and milled rumble strips were implemented in continuous. The rolled rumble strips were white on dotted marking and colour pavement in the spaces,
- spots have been always implemented on dotted shoulder road marking with rolled or milled center rumble strips,

In this driving simulator experiment, 58 participants drove on fixed-base DS and in three driving situations: a reference situation without traffic, overtaking two powered wheels and a distraction task with SMS writing (word “juin”).

An acceptability questionnaire has been completed after the driving simulation in order to assess the a priori acceptability level of the audio-tactile systems met with regard to comfort and safety.

In this driving simulator experiment a specific module has been developed in order to provide audio and vibratory feedbacks in the case of encroachment of the audio-tactile systems. These feedbacks were provided according to the practiced speed and the design of the system.

#### ○ KEY RESULTS/ACCOMPLISHMENTS

The results of the driving simulator experiment showed that:

- there are not effect of audio-tactile systems on practiced speeds,
- the participants found all audio-tactile systems: useful, efficient and non-hazardous. They are in favour of this type of systems,
- Milled rumble strips are better understood and the vibratory component is better discerned.

The results about the a priori acceptability should be confirmed with real data (i.e., naturalistic driving). Furthermore, field of uses (i.e., users target, constraints for road transport managers, winter road...) and design according to transversal profile of French roads should be specified.

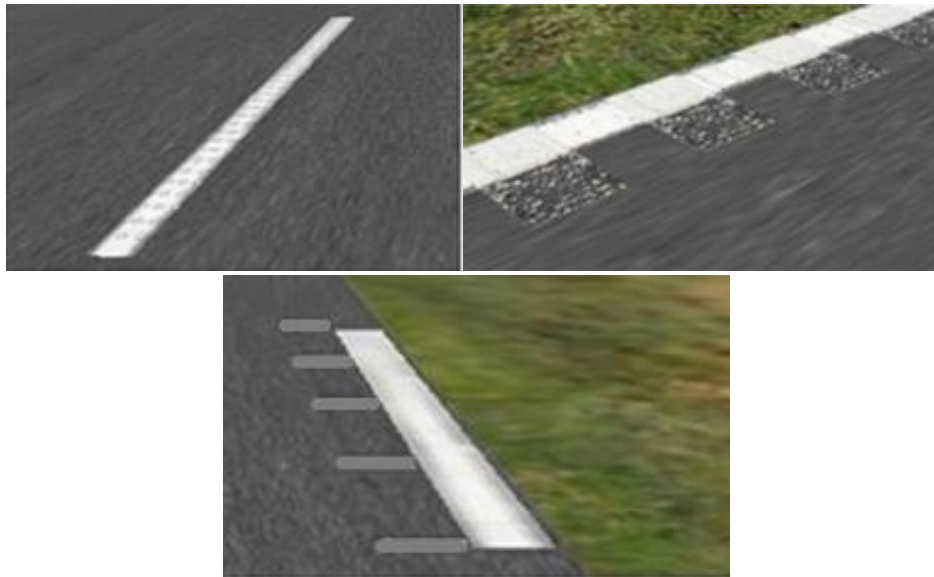

Figure 6.210 - Views of the three audio-tactile systems tested in driving simulator study – example of shoulder implementations. At left, spots (French profiled road marking). At centre, “barrettes” (rolled, of colour pavement) (French profiled road marking). At right, milled rumble strips.



Figure 6.211 - View of the fixed-base driving simulator (copyright Ifsttar, 2012)



Figure 6.212 - Views of the three driving situations. At left, the reference situation without traffic. At centre, the overtaking of two powered wheels. At right, SMS writing: word “juin” (copyright Ifsttar, 2012)

- CONTACTS

[Florence.rosey@cerema.fr](mailto:Florence.rosey@cerema.fr)

- REFERENCES

- [1] ERSO (European Road Safety Observatory), 2015. Traffic Safety Basic Facts on Single Vehicle Accidents. European Commission, Directorate General for Transport June.
- [2] RISER, 2006. European Best Practice for Roadside Design: Guidelines for Roadside Infrastructure on New and Existing Roads. RISER Deliverable D06. Göteborg, Chalmers University of Technology, 2006.



### 6.2.2.10. Optical illusion in a tunnel

#### ○ COUNTRY

Italy

#### ○ IMPLEMENTATION ORGANIZATION

University of Florence

#### ○ SUBJECT

The study analyses a possible intervention in a tunnel crossed by a two-way two-lanes road. The road has a bend to the right proceeding northbound and just before the bend there is an intersection with another existing road, which we can define as "secondary road". This secondary road is aligned with the straight before the main road curve and it is a one direction road oriented southbound.

Drivers found some difficulties in correctly perceive the geometry of the main road and therefore the presence of the bend, due to the entrance of the tunnel on the secondary road that seems to be the exit from the tunnel of the main road: it is a problem related to the field of view and to the principles of perception related to Human Factors [1].

#### ○ PROJECT DESCRIPTION AND SUMMARY

The entrance to the tunnel that serves the secondary road is visible to those who proceed on the main road in northbound direction and is almost perfectly aligned with the straight that the drivers travels before the right bend. The external light defines the entrance even better, making it a focus point for drivers attention (Figure 6.213). This causes an operational problem: drivers who are proceeding northbound are led to believe that the tunnel, and therefore the road, proceed straight, while the main road provides a curve to the right. It is an optical illusion. The consequences of an incorrect perception of the track are mainly of two types: possible speeding, as the road appears straight to the user and this leads him to accelerate, or wrong manoeuvres such as sudden changes of direction, as soon as the presence of the bend becomes clear, with possible loss of control of the vehicle.

Currently the secondary road has been closed to traffic (Figure 6.214), but the goal is to open it again to the traffic, without let this having a negative impact on road safety.



*Figure 6.213 - Reconstruction of the tunnel internal view without visual obstacles at the entrance of the secondary road*



*Figure 6.214 - Tunnel internal view with visual obstacles at the entrance and interection of the secondary road*

The secondary road was originally a two-lane road, one in each direction, so the width of the tunnel entrance is the width necessary for a two lanes passage.

The study carried out by the University of Florence has tried to find a solution to the optical problem caused by the conformation of this stretch of tunnel that did not provide the modification of road and tunnel geometry (and so very expensive interventions), but rather managed to make clear to the drivers the presence of the bend, so that they can adjust their drive behaviour accordingly.

The solution chosen was, first of all, to cover to the northbound drivers the secondary road tunnel entrance as far as possible. This could be achieved by two measures.

- The realization of a shielding wall that would guarantee the physical continuation of the tunnel wall in the external part of the curve (purple colored in Figure 6.215), which occupies almost half of the secondary roadway.
- The shielding of the left side of the secondary road tunnel entrance (looking northbound), corresponding to almost one of the secondary road lanes.

The secondary road, originally a two-ways two-lane road, is now a single lane, so the study has assumed to be able to close half of the light surface of the secondary road tunnel entrance, making it possible to keep in operation only the right lane (looking northbound). This lane will then deviate, once inside the tunnel, to the left lane (looking northbound); this allows the placing of the shielding wall in the space previously occupied by the right lane, as shown in the Figure 6.87. Although the two measures would not completely eliminate the passage of light from the secondary road tunnel entrance, the light surface would be significantly reduced.

To make the intervention even more effective, other perceptual treatments have been identified. Their aim is to clearer to the drivers that the main road develops with a right bend.

- Bright green coloring of the space between the two traffic median lines of the main road and a light color of the northbound lane, in order to create an optical guidance that highlights the curve to the right.

- Staining of the shielding wall and of the tunnel wall outside the curve with colors that keep driver's attention, moving the focal point from the secondary road tunnel entrance to the right bend of the main road.

Both interventions are visible in Figure 6.216.

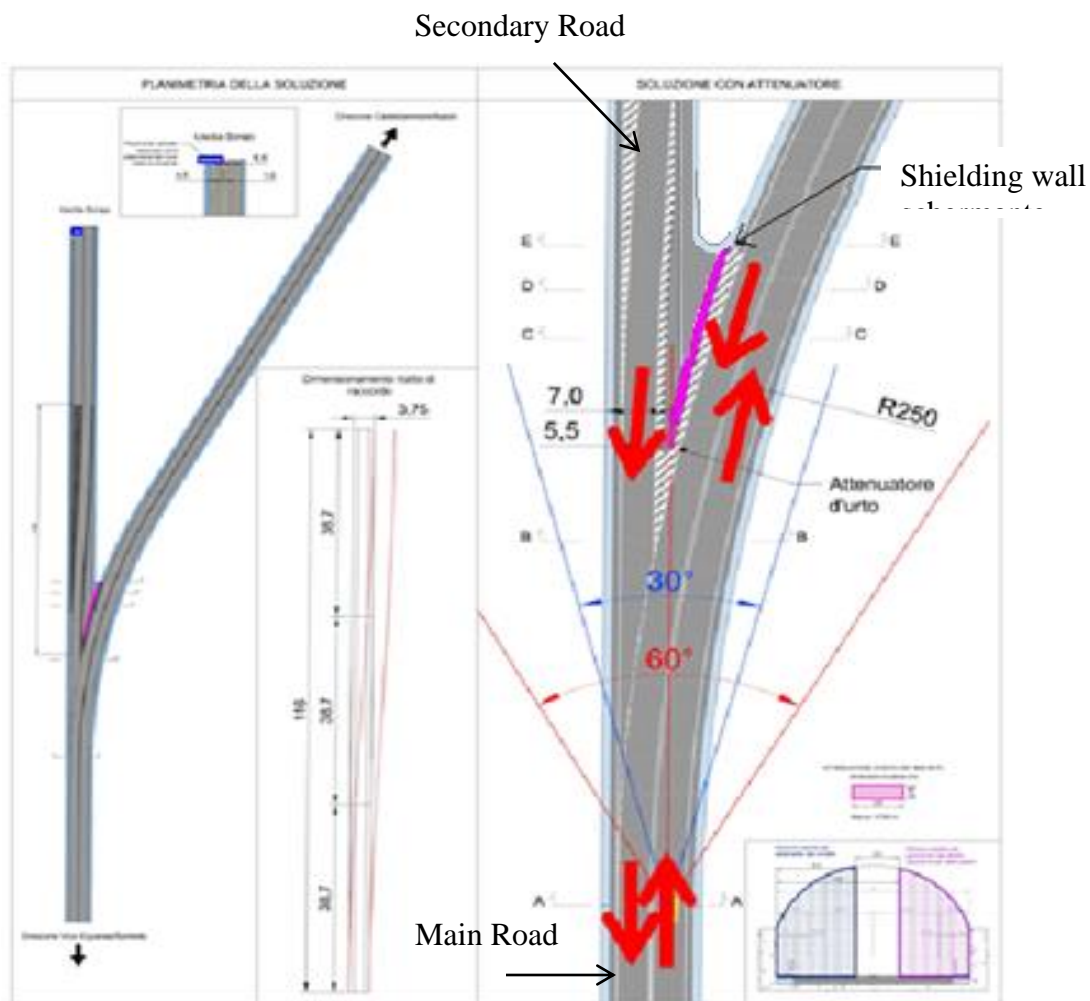

Figure 6.215 - Detail of the two main interventions designed to obstruct the view of the secondary road tunnel entrance to northbound drivers

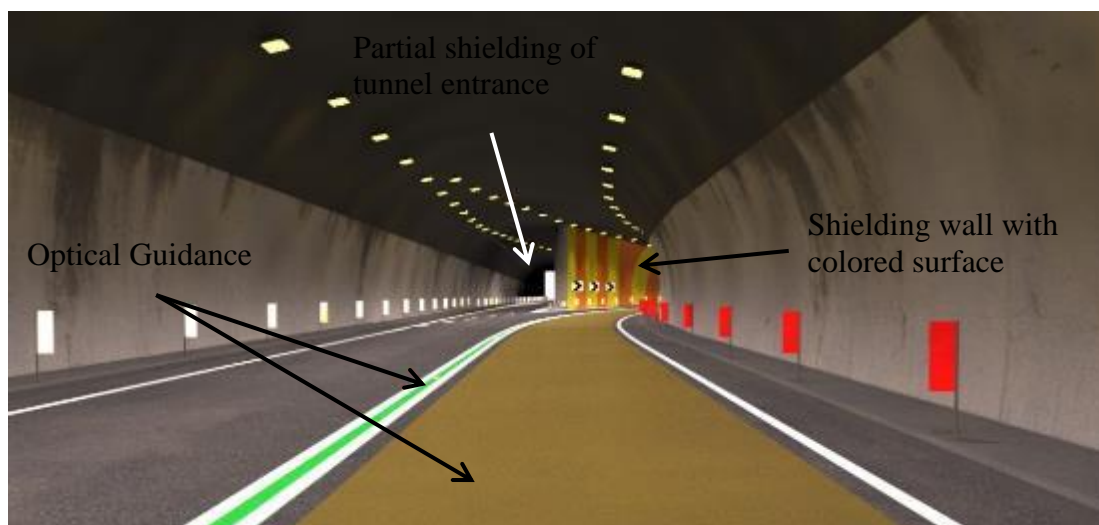

Figure 6.216 - Digital reconstruction of the project layout

#### ○ KEY RESULTS/ACCOMPLISHMENTS

The study was carried out only on a theoretical level, for which no results are available, but observing digital reconstructions, the perception of the true develop of the main road appears to be significantly improved.

#### ○ POLICIES

Problems related to the correct perception of road layout are more and more frequently analysed and resolved keeping in mind the principles of Human Factors, however it is difficult to establish the real goodness of a solution, as the one presented in this case studies, based on these principles, if not realized and its effects analysed.

#### ○ BARRIERS/OBSTACLES

The realization of the shielding wall and the partial closure of the entrance to the secondary road tunnel, have to take into account the functional and safety characteristics linked to the circulation on the two roads, in particular:

- the geometric section of the secondary road, now with only one lane, had to maintain the margin elements and widths indicated by the regulations;
- the secondary road, in deviating its axis from one lane to the adjacent one, must present a geometry that guarantees safe travel condition;
- the shielding wall must ensure that vehicles entering the main road from the secondary road have full visibility of the vehicles coming from the bend and vice versa.

#### ○ CONTACTS

[lorenzo.domenichini@unifi.it](mailto:lorenzo.domenichini@unifi.it);

[valentina.branzi@unifi.it](mailto:valentina.branzi@unifi.it);

[andrea.palioetto@unifi.it](mailto:andrea.palioetto@unifi.it)

#### ○ REFERENCES

- [1] PIARC, “Human Factor guidelines for a safer man-road interface”, 2016R20EN



### 6.2.2.11. Realization of a well-respecting 20 kmh Zone, Lignano Sabbiadoro

#### ○ COUNTRY

Italy

#### ○ IMPLEMENTATION ORGANIZATION

Lignano Sabbiadoro Municipality

*Design Team:* Proger SpA, Archest, Seste, arch. Gaetano De Napoli, arch. Michieli Zanatta, Geomok

#### ○ SUBJECT

This case study describes the project of redefinition of a long one-way straight road running beside the beach and separating it from the rest of the city. The connection function that the road must provide, have decreased along the last years because of the massive use of motorized vehicles that hardly yield to pedestrians going from the beach to the city or vice versa. This has created many points of conflict between motorized vehicles and pedestrians. A cycle path developed along the road on the same carriageway on the beach side. The cycle path was divided by the travel lane only by a continuous line and this did not prevent, in case of a traffic jam during summer periods, that powered two wheelers to temporary use the cyclist lane to overtake cars. Thus, causing the risk of collision with cyclist or crossing pedestrians that can't forecast the arrival of a motorbike from the cycle path.

The road had a 30 km/h local speed limit, but unfortunately drivers didn't comply with the speed limit. If they would have done so, the safety problems would have been very few.

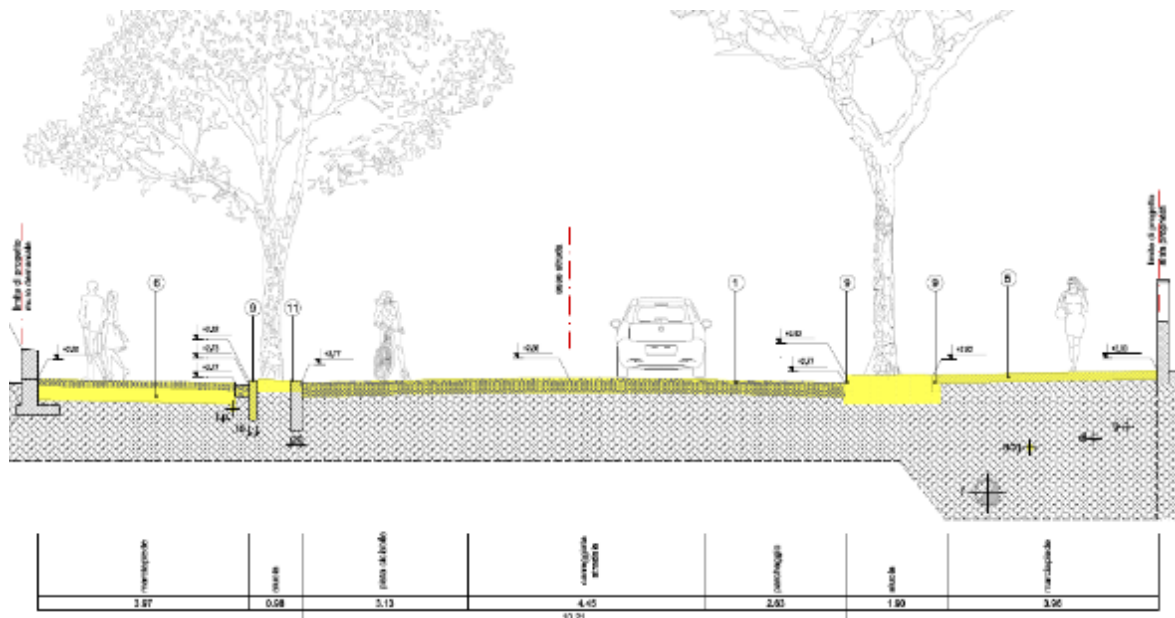

Figure 6.217 – Road section before the intervention [3]

Considering the problem from a Human Factors principles point of view [1], there are many factors which seems to be the causes of such behaviour. First of all, the conformation of the road itself, that was a quite monotonous straight with two lines of trees, one on each side of the road, that bring the focal point of the drivers to the horizon: this has the double effect of induce the driver to give less attention to critical driving challenges closer to him (i.e. pedestrian crossing) and to speed up because of the sense of a larger space available. Trees, together with parked cars, can also hide

pedestrians waiting to cross the road or cars coming from the other roads. Furthermore, the standard zebra crossing seemed to be not enough visible from the required distance. Finally, the road section was composed by the cycle path, the travel lane and parking lots lane, with a travel lane of about 4.5 m wide. Such a width can cause speeding [2].



*Figure 6.218 – Road view before the intervention [4]*

#### ○ PROJECT DESCRIPTION AND SUMMARY

The intervention wanted to re-establish the relationship between the town and the seaside reducing the splitting impact of the road infrastructure and improving road safety. The intervention interests the whole length of the road that is about 1.8 km. The solution provided for imposing a speed limit of 20 km/h to the motorized vehicles along the seaside section of the road. The solution, if the drivers will comply with the speed limit, aims to reduce the conflicts between motorized vehicles and pedestrians.

The target of the project is very ambitious because the preceding speed limit of 30 km/h was not followed, and now the new posted speed limit is 20 km/h. The key difference to achieve the target of 20 km/h is in the complete modification of the road section, the road appearance and the road environment.

In order to make the speed limit credible and improve its respect by the drivers (even during night or winter periods when the seaside activity reduces), a refurbishment intervention was designed.

The designer implicitly acted respecting the PIARC Human Factor 1<sup>st</sup> and 2<sup>nd</sup> principles "optical guidance" and "spatial perception". The new design of the road has the potential to induce users to reduce speed both in conscious and unconscious way (traffic calming effect).

The intervention included:

- The reduction of the lane width (from an average of 4.5 m to 3.5 m).
- The replacement of the cycle path with a wider one (two-way bicycle lane from an average of 3.1 m to 3.6 m). The cycle path surface will be made with different materials than the road surface (a lighter one) and a line of another different materials will be placed between the travel lane and the cycle path to improve the perception of two separate ways.

- The realization of specific treatments of the road surface texture and colour producing a rhythmic subdivision of the road environment.
- The realization of raised intersection that become a kind of optical squares (meeting places) in front of each road cross and beach establishment.
- the elimination of street markings (except parking lanes);
- the introduction of flowerbeds along both the road sides and other street furniture.

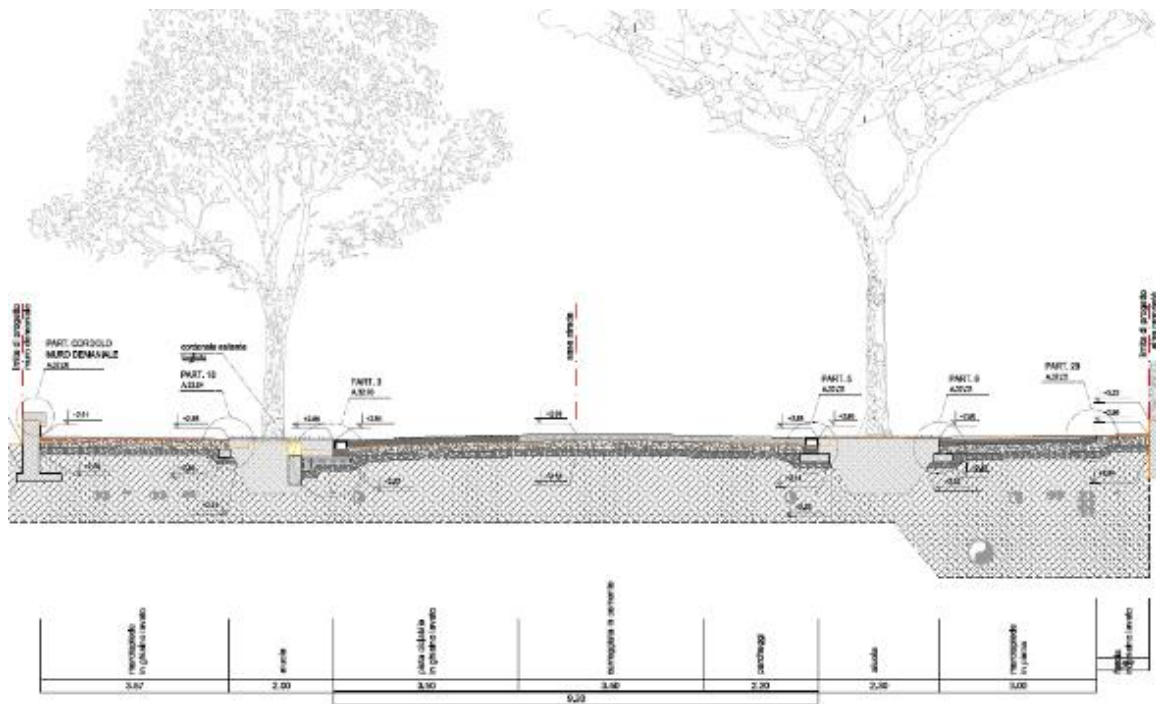

Figure 6.219 – Road section after the intervention [3]

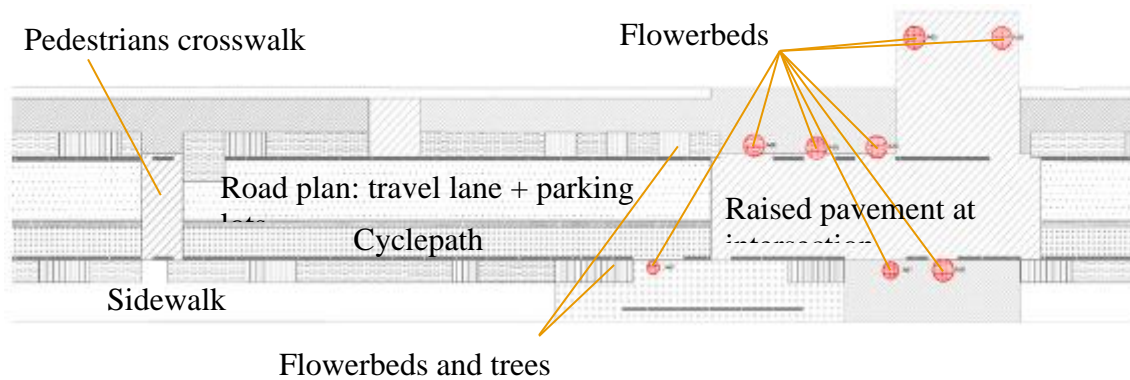
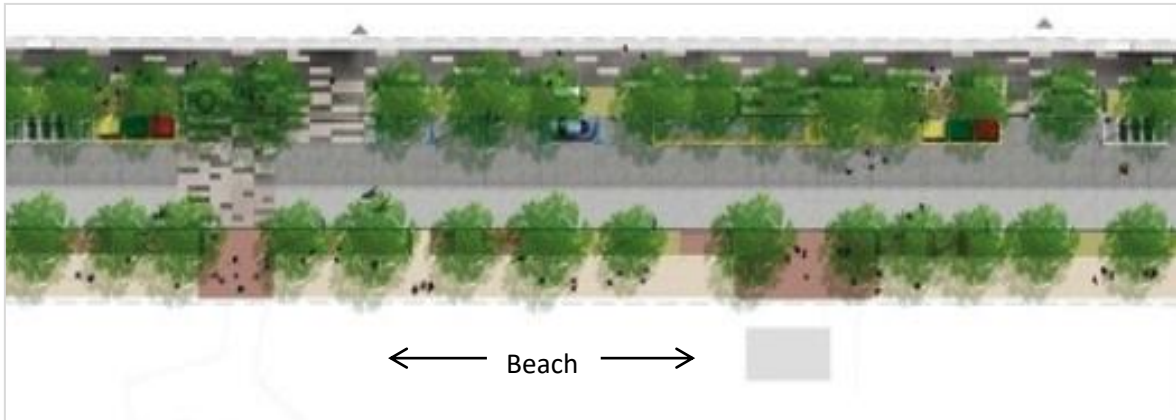

Figure 6.220 – Design of a standard road segment [3]



*Figure 6.221 – Reconstruction of the top view of a road segment [5]*



*Figure 6.222 – Detail of the junction between the cycle path and raised pedestrian crossing (square) [5]*





*Figure 6.223 – Reconstruction of the road environment view [5]*

#### ○ KEY RESULTS/ACCOMPLISHMENTS

The works are still in progress and they will be completely finished within the end of year 2018. No data are now available about the effectiveness of the intervention, but based on the experience it can be stated that the aims of the intervention are:

- Make the entire road alongside the beach a “non-road” or rather a place where mainly pedestrians, but also cyclists, are the main users, and motorized vehicles are guests. The completely modified road environment wants to underline this. If drivers will feel quite uncomfortable driving in such situation, because they understand that the road is only marginally for them, they will be much more careful and respectful.
- Alongside the general environment modification, there are also specifically technical aspects such as the travel lane width reduction and the high number of raised intersections and squares that broke the continuity of the straight, causing a reduction in speed.
- Different materials used to pave critical points as intersections and pedestrian crosswalks, make them easy to see for drivers and capture their attention. This means that drivers would notice better other road users that are crossing the road and would not place their perspective focal point to the horizon, but mainly to the closer different-paved point, causing a reduction in speed.

### ○ BARRIERS/OBSTACLES

The seafront is characterized by a double row of pines alongside each road margins.

These trees were planted during the road construction time ('30s) and are considered "historical". Citizens population, and also tourists, are very fond of these trees. The realization of the project raised remarkable concern for safety and stability of these trees, whose root system was conditioned by existing elements (curbs and pavements) that need to be removed. Remarkable concern has also aroused the result of the project itself because citizenship feared a too radical change in the image to which it was accustomed.

A Committee of citizens, with an important influence within the local Administration, was also founded. The main aim of the Committee was to protect "historical" trees and to control the new image and the new shape of the road.

Interaction with the Committee has therefore been added to the "participatory" actions already undertaken. These conditions led to a wider sharing of the project; the design was quite modified compared to the first project that included more innovative elements and provided for a less conservative urban landscape.

A portion (about half of the whole street) of the road paving, originally made with a particular technique that included the insertion of a rhomboidal metal mesh into the concrete casting, was redesigned and executed in order to reproduce the same surface.

The topic of safety and preservation of trees has been solved with specific technical measures.



*Figure 6.224 – Construction of original road paving*



*Figure 6.225 – Reconstruction of road paving*

#### ○ LESSONS LEARNED

A work like this cannot be considered simply a “work on a road” because a series of functional implications and urban meanings converge on it, which make it a very complex work. In fact, the concept for the new seafront is “a road that becomes a linear square”.

Due to all the implications that a project like this involves, probably an even wider "participation" of citizens is necessary from the early steps of the project: needs to be taken into account are countless and citizenship is often reluctant to change uses and usual environments.

#### ○ COSTS

About 20.000.000 € considering all the works (systems, subservices, lighting, etc.) alongside the 1.8 km road length.

#### ○ CONTACTS

[barbara.donada@lignano.org](mailto:barbara.donada@lignano.org)

[lorenzo.domenichini@unifi.it](mailto:lorenzo.domenichini@unifi.it)

[andrea.palioetto@unifi.it](mailto:andrea.palioetto@unifi.it)

#### ○ REFERENCES

- [1] PIARC, “Human Factor guidelines for a safer man-road interface”, 2016R20EN
- [2] U.S. Department of Transportation Federal Highway Administration (FHWA), Factors Influencing Operating Speeds and Safety on Rural and Suburban Roads, 2015
- [3] Comune di Lignano Sabbiadoro, Progetto esecutivo, “Riqualificazione e Ammodernamento del Lungomare Trieste”
- [4] Google Maps
- [5] [https://www.ilgazzettino.it/nordest/udine/varchi\\_entrare\\_spiaggia\\_lignano\\_lavori\\_lungo\\_mare-3698324.html](https://www.ilgazzettino.it/nordest/udine/varchi_entrare_spiaggia_lignano_lavori_lungo_mare-3698324.html)

### **6.2.2.12. Speed reductions scheme in a motorway work zone crossover**

#### ○ COUNTRY

Italy

#### ○ IMPLEMENTATION ORGANIZATION

University of Florence

#### ○ SUBJECT

Work zone crossover is a relevant topic when we talk about road safety [1]. Indeed, many nations do not have detailed rules on road construction, and sometimes, if they exist, these regulations do not fully take into account the exceptional conditions that a work zones creates in road environment, particularly in motorways.

One of the main problems, as evidenced by the analysis carried out for the Italian motorways work zone crossovers, is that most users do not respect the speed limits and this is due to the fact that the imposed speed limits deviate from the speed values expected by the drivers (desired speed). In fact, considering the operating speed  $V_{85}$ , the speeds detected are for the most part abundantly above the speed limits imposed. Furthermore, the analysis identifies also a great variance in the speed held by the users.

Both this factors mean that the speed limit is not credible.

The study conducted by the University of Florence was based on the application of the principles of spatial perception related to the Human Factors [2] in order to try to reduce the drivers expected speed and, in doing so, decrease and homogenize the operating speed. The objective of the study was not to modify the structure of the work zone, but to intervene on the signalling devices and on the marginal elements placed at the edge of the area in order to modifying the optical perception of the road environment.

#### ○ PROJECT DESCRIPTION AND SUMMARY

Statistics show that rear end collisions are the most common type of accident in motorway work zone crossovers. This type of accident occurs not only because of the excessive speed, but also because of the considerable difference in the speed held by each users. For this reason the homogenization of the speed, together with the reduction of the speed, were the aims of the study.



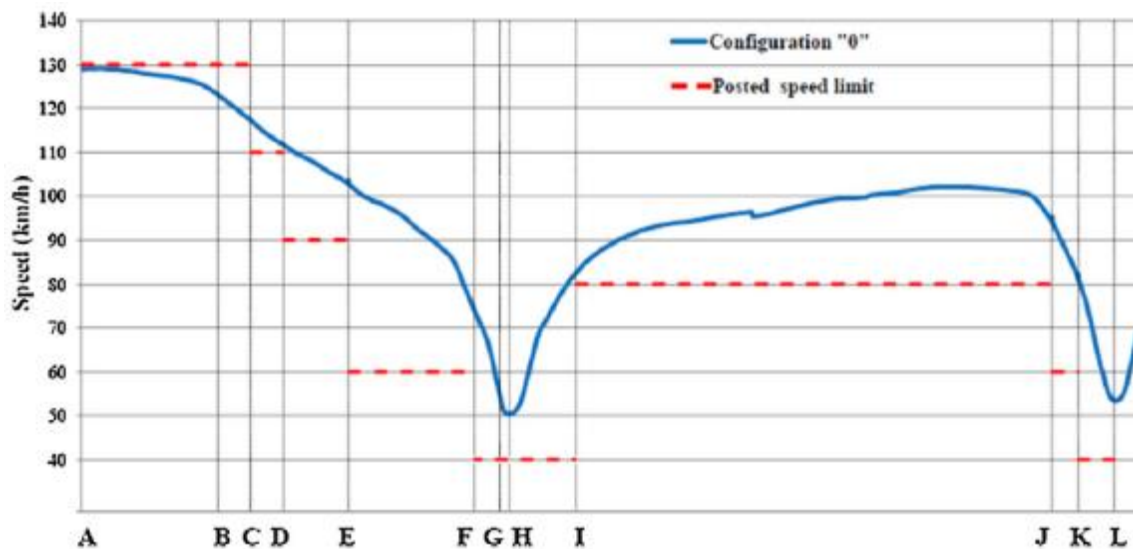

Figure 6.226 - Average speed held by users at motorway workzone crossover, with standard equipment. The letters refer to the segmentation points represented in Figure 6.229.

The drivers difficult in perceive motorway work zones as a critical areas that require more attention, and therefore a reduction in speed, suggests to use a Human Factors oriented approach to solve the problem and in particular, the realization of an intervention that succeed to lead drivers to unconsciously change their driving behaviour.

Within the study, nine different site configurations were designed for the same 7 km section of motorway and tested in a driving simulator, considering natural light and dry pavement conditions (Figure 6.227 - Examples of different configurations). The goal was to cause a reduction in speed by changing drivers' field of view.

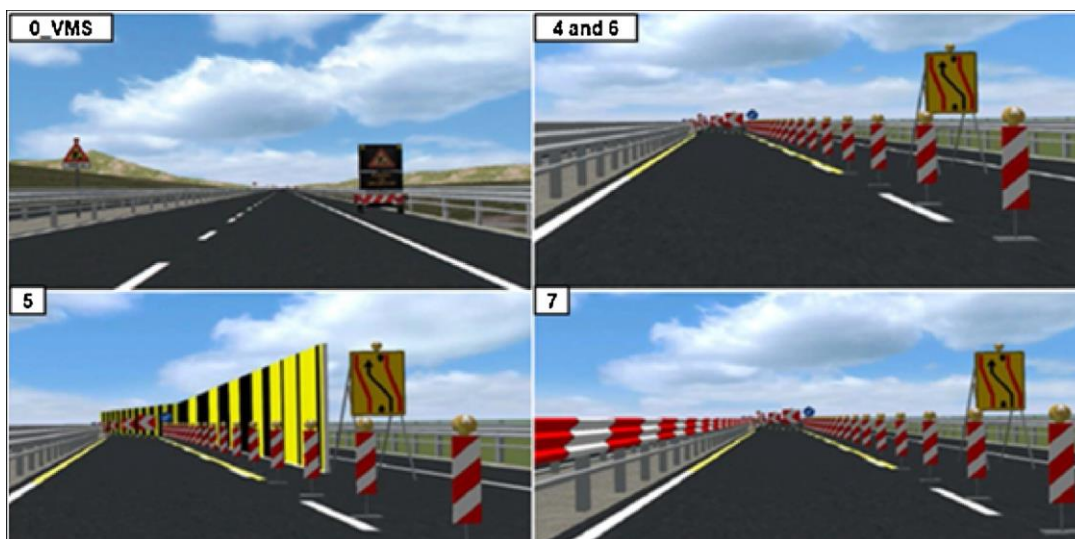

Figure 6.227 - Examples of different configurations

The study considered a work zone in a dual carriageway motorway with two lanes in each direction. An entire carriageway has been considered closed and this requires the opening of a gap to divert the traffic of the obstructed carriageway on the adjacent one. Such a work zone has an organization that includes a first part (part 1) in which the user is alerted to the presence of the work zone, a second part (part 2) in which the traffic is diverted to the innermost lane, a third part (part 3) where

the traffic is diverted to the other carriageway and a fourth final part (part 4) in which the traffic is guided back in the carriageway interested by the intervention (Figure 6.228).



Figure 6.228 - Images of the main parts of the crossover.

The standard configuration usually implemented in Italy is represented in Figure 6.229.

#### ○ KEY RESULTS/ACCOMPLISHMENT

The study carried out through the simulator, has highlighted that different configuration of the marginal elements of the work zone, modify the user's field of view, causing a modification of its behaviour. The influence takes place both consciously (a subsequent survey has shown that users have noticed the differences in configuration and have declared that they have been influenced by them) and unconsciously, because often the behaviour in different situations has diverged from what the user believed he had held.

An optimal level of optical density, which stimulates the driver without overloading him, and the reduction of the perceived spatial depth of the visual field, unconsciously leads to slowing down [2]. The amount of information to be processed influences the quality of the driving and therefore the speed of the driver [4].

The configuration that led to the best results is the "7" configuration: the one in which the median barrier was colored with white and red alternating stripes, similarly to the delineators placed on the outer edge of the lane, as shown in Figure 6.230.

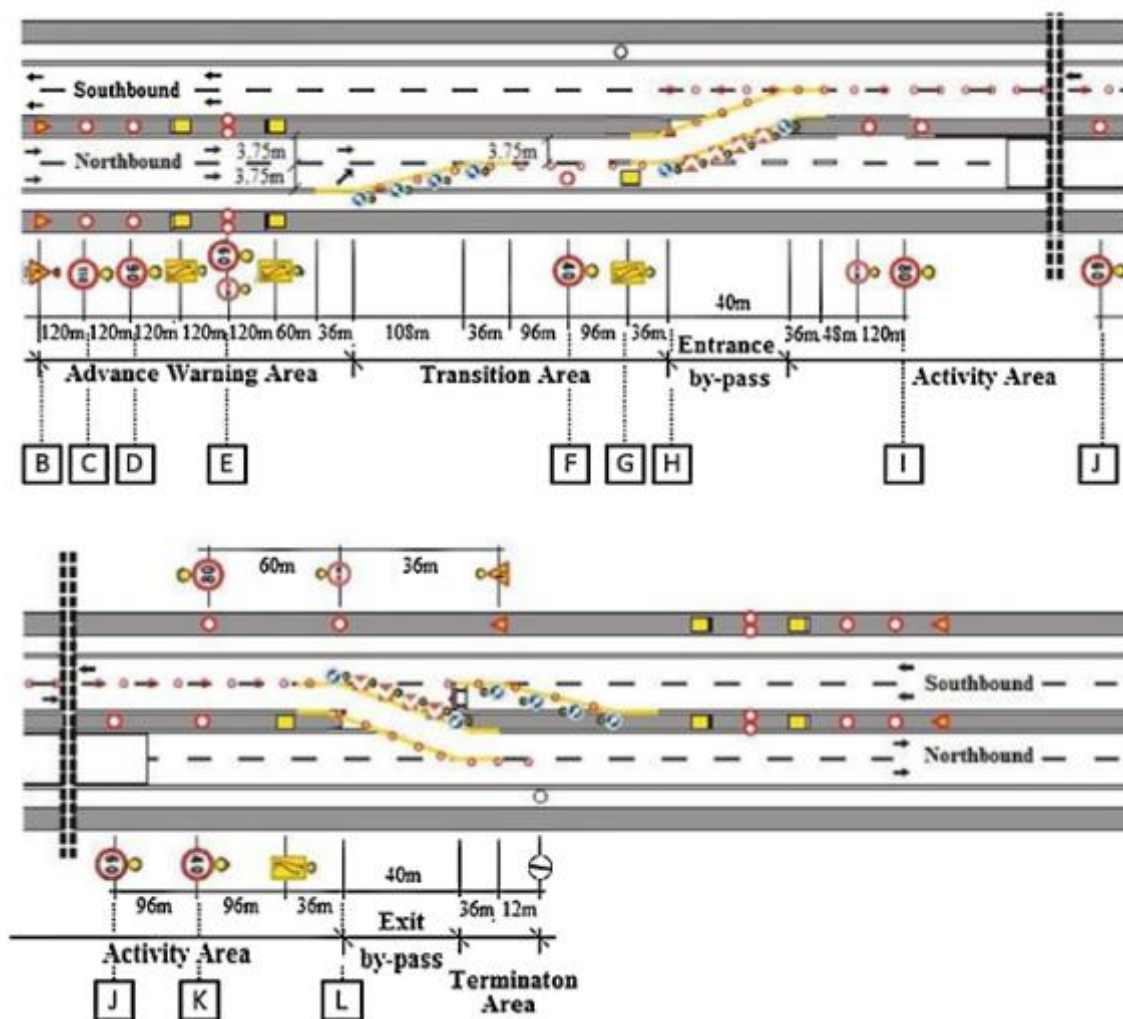

Figure 6.229 - Standard configuration for motorways with two carriageways with two lanes each



Figure 6.230 - Configuration "7"

The colour of the traffic barrier, combined with the taller and denser vertical delineators, produced the greatest speed reductions within the warning zone (part 1) and the transition zone (part 2) with a decrease of the average speed of 6-7 km/h in the segment between site B and site F (Figure 6). In the same configuration a slight variation of the average decelerations and a reduction of the maximum deceleration value ( $-0.66 \text{ m/s}^2$  instead of  $-0.81 \text{ m/s}^2$ ) in the transition area was also observed. Finally, a greater homogenization of the speeds within the work zone area is observed

compared to the area before the work zone. In this configuration a percentage reduction of the speed variation equal to 11% was recorded.

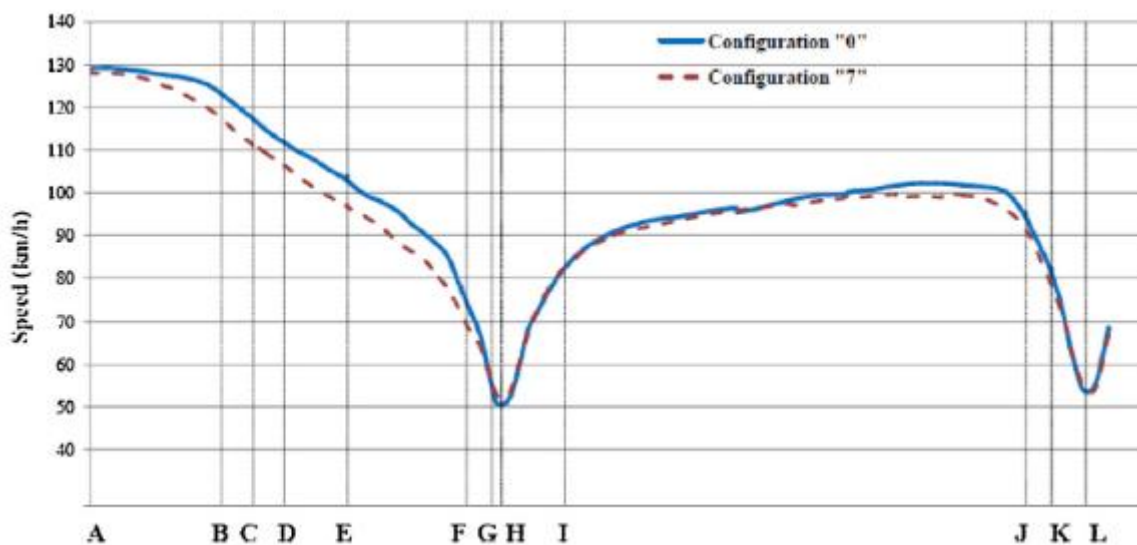

Figure 6.231 – Comparison between average speed of standard configuration “0”, and configuration “7”

Configuration		Measurement site					
		A	B	C	D	E	F
0	Mean Speed (km/h)	129.03	123.12	117.32	111.74	103.81	74.14
	Std. Dev. (km/h)	9.59	12.14	13.23	13.26	13.22	14.98
	Variance (km <sup>2</sup> /h <sup>2</sup> )	92.03	147.48	175.09	175.87	174.67	224.39
7	Mean Speed (km/h)	128.61	117.36	110.22	106.04	97.29	69.08
	Std. Dev. (km/h)	9.83	14.53	14.97	15.61	13.97	11.99
	Variance (km <sup>2</sup> /h <sup>2</sup> )	96.57	211.19	224.03	243.63	195.13	143.76

Configuration		Measurement site					
		G	H	I	J	K	L
0	Mean Speed (km/h)	54.59	50.42	82.52	95.34	82.32	53.50
	Std. Dev. (km/h)	11.68	10.02	7.20	12.89	12.65	9.95
	Variance (km <sup>2</sup> /h <sup>2</sup> )	136.38	100.45	51.82	166.03	159.95	99.01
7	Mean Speed (km/h)	55.21	52.08	82.70	91.44	78.45	54.10
	Std. Dev. (km/h)	9.27	9.30	11.36	15.82	15.94	9.62
	Variance (km <sup>2</sup> /h <sup>2</sup> )	85.98	86.53	129.01	250.28	254.10	92.55

Figure 6.232 – Comparison between average speed, standard deviation and variance in configuration “0” and “7”

#### ○ POLICIES

Speed reduction within motorway work zone areas is a very important issue in terms of road safety because very often drivers do not adapt their speed to match that imposed speed limits because they believe, on the basis of what they see, to be able to travel the road at speeds greater than those imposed. Using enforcements to control speed is not always possible, but the study showed that the use of particular perceptual treatments and small variations in the marginal equipment of the work zone site, can significantly contribute to speed reduction.

#### ○ BARRIERS/OBSTACLES

The results derive from a study made by the simulator, therefore it will be necessary to carry out real experimentations before being able to state without doubts that this intervention leads to real benefits for road safety. Moreover, despite the improvements in terms of speed reduction, these



are not yet sufficient, and drivers continue to keep travel speeds higher than those imposed by the limits.

#### ○ LESSONS LEARNED

The results have confirmed the literature results that indicate a generalized excess speed within motorway work zone crossovers. The configuration "1" provided for the insertion of higher speed limits, keeping the work zone configuration unchanged: this did not change the average driving speed. This seems to indicate that the speed held by the users is not influenced by the imposed speed limit, but mainly by the perceived characteristics of the field of view and this is confirmed by the fact that a speed reduction (up to 7 km/h) is obtained by introducing visual countermeasures that increase the optical density of the field of view (configurations "5" and "7").

#### ○ CONTACTS

[lorenzo.domenichini@unifi.it](mailto:lorenzo.domenichini@unifi.it);

[valentina.branzi@unifi.it](mailto:valentina.branzi@unifi.it);

[andrea.palioetto@unifi.it](mailto:andrea.palioetto@unifi.it)

#### ○ REFERENCES

- [1] PIARC, "Improvements in safe working on roads", 2012R29EN
- [2] PIARC, "Human Factor guidelines for a safer man-road interface", 2016R20EN
- [3] Ministero delle Infrastrutture e dei Trasporti, 2002. Decreto 10 luglio 2002:Disciplinare tecnico relativo agli schemi segnaletici, differenziati per categoriadi strada, da adottare per il segnalamento temporaneo. MIT, Via G. Caraci 36, Roma.
- [4] Yerkes, R.M., Dodson, J.D., 1908. The relation of strength of stimulus to rapidity of habit-formation. J. Comp. Neurol. Psychol. (18), 459–482.

### 6.2.2.13. Sequence design of the internal space of the tone suppressing speed excess

#### ○ COUNTRY

Japan

#### ○ IMPLEMENTATION ORGANIZATION

Road administration

#### ○ SUBJECT

In the long tunnel, the monotonous landscape, such as walls and evenly spaced lighting, keeps the monotonous landscape, which makes the driver easy to lose sense of distance, speed, direction. Also, it seems to feel a sense of strangeness and obstruction near the doorway. These are known to make it easier to lose control of speed.

In such a long tunnel, it is a case where the problem was solved by applying sequence design to the wall of the tunnel. Sequence design promotes driving that unconsciously recognizes the traveling environment and adapts to the driving environment without letting the driver feel stressed. As a result, improvement of safety and smoothness is expected.

In the tunnel with the sequence design, we confirmed by the questionnaire survey that it will ensure the comfort of users. Moreover, there are opinions such as "I was able to experience speed rising", which is considered to lead to an improvement in safety.

#### ○ PROJECT DESCRIPTION AND SUMMARY

In the long tunnel, the monotonous landscape, such as walls and evenly spaced lighting, keeps the monotonous landscape, which makes the driver easy to lose sense of distance, speed, direction. Moreover, I feel a sense of incompatibility and blockiness near the doorway. These are known to make it easier to lose control of speed.

In order to improve and reduce these problems, we introduced a sequence design in the Chubu Jukan Automobile Highway Takayama-Kiyomi Road Odori Tunnel (extension 4.3 km).

#### Deployment of Wall Patterns

The flow of the landscape that continues to develop with time during traveling was designed with a gradual change from the entrance to the exit through the entire tunnel of about 4 km, further enhancing the psychological effect and the visual effect. In order to obtain a smooth running feeling and a gaze guidance effect which does not become a visual obstacle during driving, a stripe shape extending in the traveling direction was basically taken.

#### A pattern array that senses spatial broadening

In order to alleviate the feeling of clogging of the narrow tonnage space at least, we can feel the space widening by manipulating the pattern appearance (arrangement and strength). In the lower part near the road surface, the pattern was long and the upper part was arranged in a shorter direction, so that the sense of depth against the wall surface was expressed in a deep sense. In addition, even with regard to the color scheme, it is possible to use a lower brightness, darker (darker) color near the road surface, and a slightly brighter (lighter) I created a space that was easy.

○ KEY RESULTS/ACCOMPLISHMENTS

As a result of conducting an anchor survey for users of Odori tunnel, it was confirmed that the user recognized the flow of space recognized by the driver and felt the change of the running position.

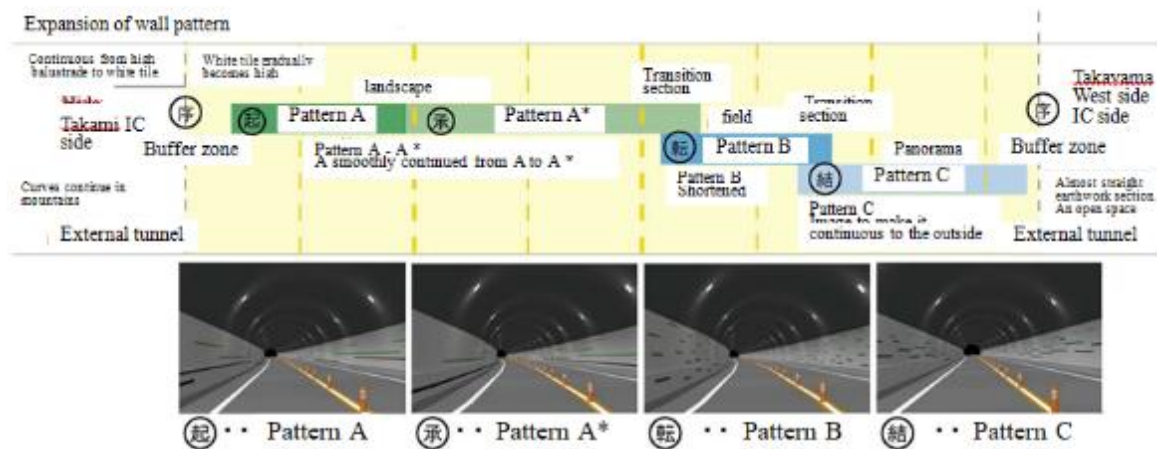
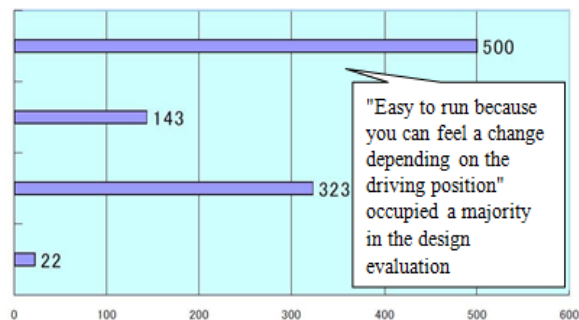

Figure 6.233 - Design of each pattern

- a. Easy to run because you can feel the change depending on the driving position
- b. I was able to experience the speed going up
- c. I think that it will not change even without a pattern
- d. Hard to run



Reference: Number of questionnaire distribution = 17,500 votes, collection votes = 1,354 votes

Figure 6.234 – Questionnaire result on design

○ POLICIES

Consideration that the increase in speed in the tunnel is caused by the decrease in space cognitive ability

To further enhance the psychological effect and visual effect, a design that can obtain a smooth running feeling and a gaze guidance effect that does not become a visual obstacle during driving is installed on the wall

○ CONTACTS

ozaki-y82ac@mlit.go.jp

○ REFERENCES

- [1] On Sequence Design of Odori Tunnel (Masahiro Unemoto, Homeland technology research presentation by MLIT, 2005)

<http://www.mlit.go.jp/chosahokoku/h17giken/program/kadai/pdf/ippan/bos2-05.pdf>

#### ***6.2.2.14. Low cost Engineering Measures on a dangerous trunk road: Road signing and marking***

○ COUNTRY:

Portugal

○ IMPLEMENTATION ORGANIZATION:

Junta Autónoma de Estradas (JAE - Portuguese Road Administration at the time of the study - 1998).

○ SUBJECT:

The example case study describes the approach used in 1998 by the Circulation and Safety Division of the Portuguese Road Administration (JAE) to improve road safety on the curves of a single carriageway two lane trunk road that connected the Portuguese coastal area and Spain (route IP 5). In a first phase, LCEM were applied, to improve the road characteristics; in a second step, exceptionally intense and severe law enforcement actions were employed by the police, to improve driver behaviour.

LCEM are physical interventions on the road specifically designed and implemented to enhance the safety of the road system, that have a low capital cost and can be implemented quickly [1].

The LCEM interventions were carried out on a 170 km road section, beginning in Albergaria (at the interchange with the IC 2 route) and ending in the Portuguese-Spanish frontier (see Figure 6.236). Several criteria dictated the choice of this type of intervention: very high average daily traffic volumes (between 4400 and 10000 vehicles); the high heavy vehicle traffic volumes, both in absolute numbers and expressed as a percentage of the total number of passing vehicles (between 1700 and 3450 vehicles, 17% to 32%); the importance of IP 5 in the Portuguese road network in those days, due to its use by a significant percentage of the international road traffic originating from or arriving to Portugal; the high number of casualties resulting from road accidents (35 fatalities and 37 serious injuries in 1997, as a consequence of 508 accidents), as compared with other similar roads and some notable accidents that were thoroughly covered by the media gives the size of the problem (see Figure 1). IP 5 was known in the media as the 'death road'.

It was expected that this measure, providing a consistent signing of the most hazardous curves, would contribute to a better understanding of their curvature and length, improving expectancies concerning their geometry, and would mitigate run-off-lane accidents and head-on collisions on these curves.

This case study is about interventions in horizontal curves on IP 5.



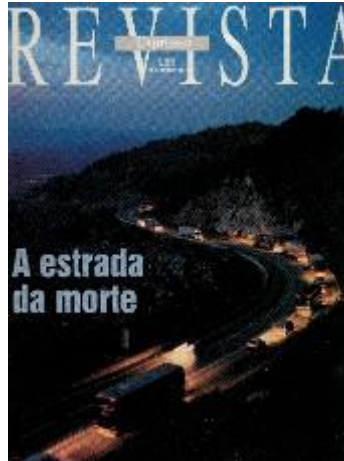

Figure 6.235 - Cover of a weekly magazine from the 25th October 1997, about IP5 “The death road”

○ PROJECT DESCRIPTION AND SUMMARY:

This section of IP 5 was built in the 1980's, as a by-pass to EN 16, an old national road connecting the same destinations and that crosses the towns of Viseu and Guarda. The layout of this “EN 16 by-pass” had modified quarter cloverleaf interchanges, with T junctions on the roads linked and the roads crossing at split-level.

In 1985, as a result of the approval of the new National Road Plan, the “EN 16 by-pass” was classified as a Main Route (IP – classified trunk road) and reconstructed accordingly. It was the first IP to be completed as such. The road design was changed during the construction phase, mainly in what concerns the layout of the interchanges [2].

The design changes consisted mainly in: modifying the interchanges, into new ones without left turns on the main road – although, in some cases, with some substandard design parameters; the introduction of additional climbing lanes; the introduction of rest areas, service areas and parks; the introduction of escape ramps with arrester beds; and the implementation of an integrated alert and information system, which included a network of emergency telephones (spaced 3 km), and meteorological stations and escape ramp occupancy detectors (both associated to variable message signs).

Head-on collisions and run-off-the road (namely on curves, on approach zones to interchanges, and on sections with climbing lanes) were the most frequent types of accidents occurring in IP 5. These accidents were mostly related to speeding and miscalculated overtaking.

In the late 1990's, a major renewal of the IP 5 layout was already being planned, with the introduction of double carriageway in several links and its future upgrading to a motorway (currently renamed as A 25, constructed between 2003 and 2006). While this reconstruction was not fully implemented, LCEM were implemented to quickly improve road safety conditions in the section between Albergaria and Vilar Formoso.

Three subsets of measures were defined, as summarised below [3]:

- Traffic safety improvement on interchanges, namely by improving their legibility and visibility, and by ensuring a better operation uniformity and predictability for traffic leaving and entering IP 5 (see Figure 6.236);

- Overall improvement of traffic operation and safety, using changes in road environment and measures to influence driver behaviour;
- Traffic operation improvement on sections with climbing lanes, namely by application of traffic regulations increasing the number of passing opportunities for cars.

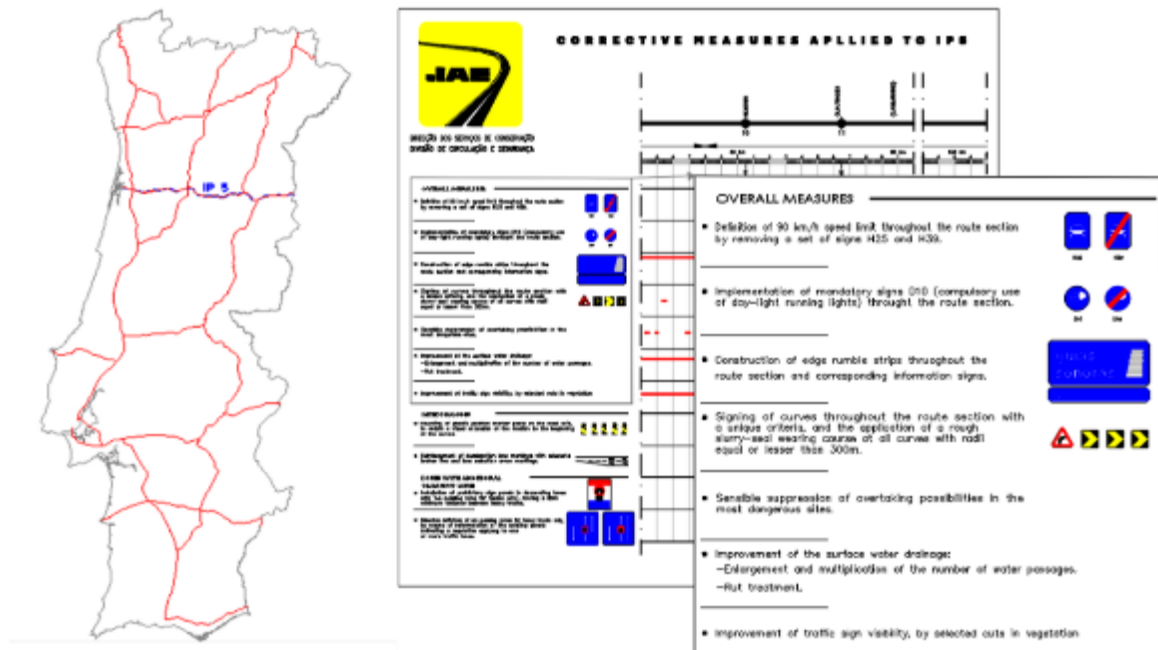

Figure 6.236 - Location of IP 5 on the Portuguese trunk road network (1998) and schematic layout plan of corrective measures (example)



Figure 6.237 - Curve signing with danger warning and chevron alignment signs

The second subset of eight measures included two that aimed at speed reduction and lane keeping [3]:

- Signing of curves throughout the route section with a unique criteria, similar to the one proposed in Work Package-6 of the SAFESTAR Project, and the application of a rough slurry-seal wearing course at all curves with radii equal or lesser than 300 m – this intervention included 15 curves (see Figure 6.237);

- Construction of edge rumble strips (*thermoplastic lines which create a whirring sound when driven over*) throughout the route section, complemented with corresponding information signs (see Figure 6.238).



Figure 6.238 - Edge rumble lines and corresponding information sign

Sharp horizontal curves ( $R \leq 300$  m) were treated with advance warning and chevron signs (see Figure 6.237). Chevrons were located so that the driver could see three chevrons at any moment (before the curve and all along the curve until the change in alignment eliminated the need for the signs – Figure 6.239), to correctly evaluate its curvature and have continuous guidance along the curve.

Thermoplastic rumble strips over the edge line throughout the route section complemented the information regarding the course of the road under rain conditions, namely on curves. The rumble strips were 6 mm high reflecting headlights despite the water film.

These countermeasures covered two Human Factors rules (the 6 Seconds and the Field of View).

The drivers were alerted to the existence of the small radius by the advanced warning and chevron signs (6 Seconds rule) located with a unique criteria along this section of IP5.

The three chevron signs seen by the driver all along the curve provide clear information about the curvature (three points define one and only one circular curve radius). The combination of the pre-existing delineators, the chevron signs and the profiled edge line markings (enhancing delineation of curves for driving at night and under adverse atmospheric conditions, namely rain) offered strong visual guidance, thus fulfilling the Field of View rule.

This methodology was later included in the Portuguese “Normative Disposition Criteria for location of road signs” [4].

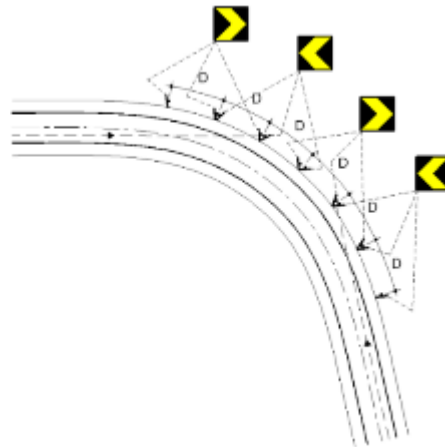











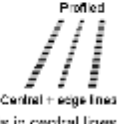

Figure 6.239 - Multiple succession location of chevron signs

For two-way two-lane roads, the need for chevron signs in horizontal curves is determined based on the consistency class of each curve, which depends on the length of the tangent section, the approach average bendiness and the increase in the expected number of accidents, as modeled statistically [5]. In practice, the consistency class is estimated using the PERVEL software [6]. The classification of each curve determines the type of traffic guidance equipment, road signing and marking to apply – see Figure 6.240. The most dangerous curves fall in class D, where multiple chevron signs are recommended, in addition to other measures such as profiled marking.

EQUIPEMENT	CONSISTENCY CLASSES			
	A	B	C	D
Delineators or chevrons				
Road signs				
Road markings	 Normal Central + edge lines	 Normal Central + edge lines	 Profiled Central + edge lines Retroreflecting road studs in central lines	 Profiled Central + edge lines

The advisory speed is determined as a function of the curve characteristics

Figure 6.240 - Curve signing as a function of consistency class

The chevron signs spacing is calculated based on the visibility distance and is coordinated with the delineators spacing, so that their longitudinal locations are harmonized, as shown in Figure 6.241.



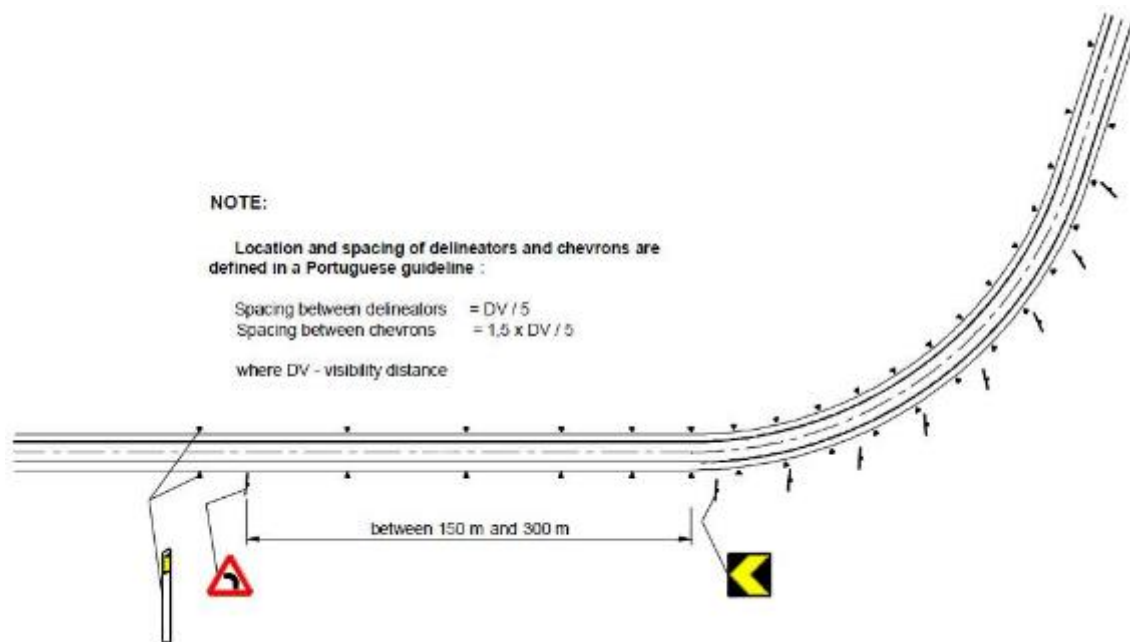

Figure 6.241 - Location and spacing of delineators and chevrons signs in the Portuguese guideline

Figure 6.242 shows the project for signing the so called “Curva do Alvendre” where several fatal run-offs the road accidents occurred, with vehicles leaving the road towards the outer side of the curve. A picture of the actual improvement is included.

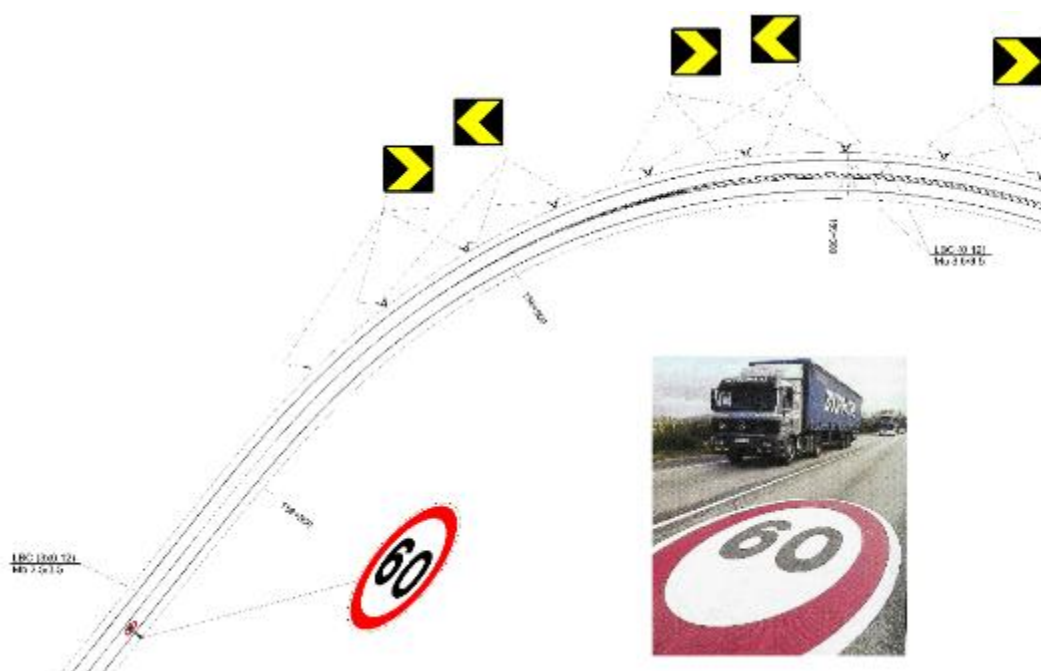

Figure 6.242 - Example of the use of chevron signs and a prohibitory sign on the road pavement (complementing an equivalent vertical sign)

Figure 6.243 shows signing of a Class D curve, just after an old bridge in a national road in Alentejo. The application of LCEM resulted in better curve negotiation performance (for both light and heavy vehicles) and in a considerable reduction in the number of vehicles running on the inside shoulder. Before-after studies allowed to observe more uniform distribution of the trajectory transversal positions (namely in curves) with these LCEM [8].



*Figure 6.243 - Example of an existing Class D curve*

○ KEY RESULTS/ACCOMPLISHMENTS:

As a result of the set of measures implemented general driver behaviour became more homogeneous.

Significant reductions in desired speeds were achieved at the observed curves, and travel paths on curves were more in accordance with the designed lane (less "cutting the curve" trajectories). Reductions in average speeds related to LCEM ranged between -11 km/h and -5 km/h.

Safety impacts were analyzed using an observational before-after study, with all other Portuguese Road Network IP category roads as control sections. The expected number of accidents were used as the safety performance variable, and the multivariate regression empirical Bayes method described by Hauer [10] was used in the analysis. A four year "before" period (1994-97) was considered; the "after" reporting period consisted of years 2001 and 2002. Years 1999 and 2000 were not used because in that period a strong and strict enforcement activity was applied throughout the whole IP 5 road, leading to a massive reduction in the annual number of injury accidents and victims. Strict enforcement was abandoned, and regular enforcement re-established before the end of 2000.

In this study it was concluded that the number of expected injury accidents was reduced by 12% due to the LCEM, from 428 to 377 injury accidents (also, a reduction of 41% was estimated, as resulting from the compound effect of LCEM and strict enforcement). The annual number of registered fatalities was reduced from 85 to 52 (by 39%), and the annual number of killed and seriously injured victims diminished from 188 to 125 (by 34%) [11].

○ POLICIES:

The systematic application of low-cost road and traffic engineering measures at high risk road sections is a cost-effective method for reducing accidents and their consequences. Furthermore, considering the usual time-span of the road infrastructure life cycle, it is a fast method, as well. Usually associated with the correction of high-risk road sites (also known as 'black-spots'), LCEM may be applied also to high-risk route sections, as in the described example.

The described case was the first time that LCEM were applied in Portugal to a route section. The extent and unprecedented nature of the measures proposed and applied were the reason for having a research institute (LNEC) to evaluate their impact on accidents and driving behaviour.

In fact many of these LCEM were used for the first time in Portugal: continuous rumble edge lines; compulsory use of daylight running lights; definition of no-passing zones for heavy trucks on climbing lane sections; use of position marker posts at the road axis to provide a non-physical median; and specially the consistent signing of curves throughout a route section.

Afterwards, the exceptionally intense and strict law enforcement actions employed by the police throughout the route section were also applied for the first time in Portugal [9].

○ LESSONS LEARNED:

The use of new types of LCEM on a road must be done with great caution and using before-after studies to provide information about their impact in road safety and driving behaviour, as it was the case of this intervention on curves.

So transferability of this type of LCEM is not a linear matter and should be done with the most caution.

○ COSTS:

The three sets of corrective measures of the road infrastructure were executed during the first semester of 1998 (see Figure 2 [7]). The total cost of these interventions was about 925 000 €, about 5 400 €/km (at 1998 prices) [8].

Experience has shown that benefit/cost ratios between three and 24 may be achieved, in countries where moderate to high monetary values are attached to the prevention of death and injuries resulting from road accidents (FHWA, 1993). No cost/benefit analysis was carried out for this set of LCEM; however, the reduction in the expected annual number of injury accidents corresponds to an annual social cost of 370 500 €, at 1995 prices [12].

○ CONTACTS:

Carlos de Almeida Roque - [carlosalmeidaroque@gmail.com](mailto:carlosalmeidaroque@gmail.com);

Dr. João Lourenço Cardoso - [joao.lourenco.cardoso@gmail.com](mailto:joao.lourenco.cardoso@gmail.com)

○ REFERENCES:

- [1] ETSC “Low-cost road and traffic engineering measures for casualty reduction”. Brussels: European Transport Safety Council. 1996.
- [2] Nascimento, A. “IP5 - Improvement of operational conditions” (in Portuguese language). Junta Autónoma de Estradas, Almada, Portugal. 1996.
- [3] Almeida Roque, C. “IP5 Improvement of safety conditions” (in Portuguese language). Informação N° 97/DSCs/DCS. Junta Autónoma de Estradas. Almada, Portugal. 1998.
- [4] Almeida Roque, C. “Technical Disposition Criteria for location of road signs” (in Portuguese language). INIR. 2009. Lisboa, Portugal.
- [5] Cardoso, J.L. “Detection and low-cost engineering improvement of inconsistent horizontal curves in rural roads”. Paper presented at the 12th International Conference Road Safety on Three Continents 2001. FERSI/VTI/TRB, Moscow.

- [6] Cardoso, J. L.; Gil, J. P. “Manual de utilização do programa PERVEL” LNEC, Lisboa, 2002.
- [7] Macedo, A. L., Almeida Roque, C. “Low cost measures for safety improvement - Considerations about their application in Portugal”. Seminar “Medidas de Engenharia de Bajo Coste para Carreteras más Seguras”. Association Española de la Carretera and European Transport Safety Council (ETSC). Bilbao, Spain.1998.
- [8] Impact of Traffic and Safety Measures on Driver Behaviour on the IP 5 Road (2nd Report) (in Portuguese language). Cardoso, J. L. LNEC. Lisbon, Portugal. 2000.
- [9] Almeida Roque, C., Cardoso, J.L. “Low cost engineering measures and stricter enforcement. A successful combination to improve road safety on a dangerous rural route”. Routes/Roads N° 311, July 2001. World Road Association (AIPCR/PIARC). Paris, France.
- [10]Hauer, E. “Observational Before-After Studies in Road Safety”. Tarrytown, New York: Pergamon/Elsevier Science, Inc.
- [11]Cardoso, J. L. “The effect of low cost engineering measures and enforcement on driver behaviour and safety on single carriageway interurban trunk roads”. In Advances in Human Aspects of Road and Rail (ISBN 9781439871232).
- [12]Macedo, A.L.; Cardoso, J.L.; Arsénio, E.; Dionísio, A.; Figueiredo, A. – Participation of LNEC on the studies on allocation costs of using transport infrastructures. 2<sup>nd</sup> Report. Report nº 59/00; NTSR, Procº 093/01/13563. LNEC, Lisboa, March 2000 (in Portuguese language).



### **6.2.2.15. Changing the Character of Roads within Silver Zones to lower speed limits**

#### ○ COUNTRY

Singapore

#### ○ IMPLEMENTATION ORGANIZATION

Land Transport Authority

#### ○ SUBJECT

The case study covers the Silver Zone program implemented in Singapore since 2014. The program is designed to further enhance road safety of the elderly at large in the neighborhood precincts. Silver Zone aims to change the character of the street such that traffic movement is slowed down significantly to below 40km/hr and there will also be better walkability infrastructure to enhance road safety and first-and-last mile connectivity. A wide variety of traffic calming measures are incorporated into the Silver Zones, to better manage vehicles' speeds and thus creating a safer environment for the elderly pedestrians to maneuver safely to the key amenities, taking into consideration their slower walking speeds. Most of the adopted traffic calming countermeasures are based on the principle of Human Factors [1].

#### ○ PROJECT DESCRIPTION AND SUMMARY

Senior citizens are considered one of the most vulnerable road users, and some of the common problems that affect their ability to cross roads safely are muscle atrophy, arthritis and sight problems.

As of 2013, seniors constitute about 16% of Singapore's total resident population, and this number is projected to increase every year. Apart from that, they are also over-represented in pedestrian fatalities and injuries.

The Silver Zone program was first started in 2014. The main objective of the program is to enhance road safety for elderly pedestrians, one of the vulnerable road users. This program involves the installation of elderly-friendly road safety features in residential areas with high elderly resident populations, relatively higher accident rates involving elderly pedestrians and closer proximity to places where the elderly pedestrians frequented. These features are customized to site conditions and to remind motorists to slow down and look out for pedestrians, as well as to urge elderly pedestrians to exercise greater care when crossing the road.

Some of these road safety engineering improvements implemented within the Silver Zones include:

- Silver Zone gateway treatment with signage and road markings to inform motorists that they are entering into a special zone and to look out for pedestrians. Yellow color is used to catch driver attention and the gateway layout inform drivers that they are entering an area that differ from the rest of the road.



*Figure 6.244 – Silver Zone gateway*

- reduced speed limit to 40kph to slow down motorised traffic.
- pinch-points to create road narrowing effect and shorten pedestrians crossing distance (shorten time exposed to moving traffic).
- eye-land to create a widened pedestrian refuge in the middle for pedestrians to rest momentarily before continue crossing the road and acts on the drivers behaviours: drivers can easily see the presence of the pedestrian crosswalk because is in correspondence of the eye-land that capture the attention of the driver; furthermore the eye-land creates a deflection of the lanes trajectories and this force the driver to go slow.
- chicanes to create curves along straight roads to slow down vehicles' speeds in two ways: forcing them to slow down in order drive safe inside them, and catch the drivers attention while they're approaching the chicanes, avoiding them to move their focus point to the horizon, at the end of the straight.
- raised junctions and road humps to slow down vehicles' speeds and catch the attention of the driver in that critical point.
- roundabout to facilitate orderly traffic flow to reduce traffic conflict points at unsignalized junction.
- additional ramp downs at kerb side to channel and consolidate pedestrians to cross at targeted points while in the meantime help to ease crossing activities for elderly pedestrians and the mobility challenged.
- extension of center dividers throughout the Silver Zone to create two-stage crossings.
- wider footpath to better facilitate walking activities on the footpath.

- extended green man phase at signalized crossings to allow elderly pedestrians to cross with ease.



*Figure 6.245 – Example of implemented Eye-land*

The total of these countermeasures creates an area where drivers field of view is completely different from the standard road configuration and continuously changing, this influence the driver behaviour making the driver more focused and attentive.

These improvements are targeted to slow down motorists and provide convenient and additional crossing points for the pedestrians to enhance walkability within the neighborhood and the Human Factors principles have helped understanding the right solution to implement. The Silver Zone program will be extended to a total of 50 locations by 2023.





*Figure 6.246 – Example of Chicanes*

Continuing effort is made to ensure that the completed Silver Zones remain effective by carrying out necessary enhancements to the traffic schemes when needed from time to time. Apart from that, new initiatives are being studied and will be implemented in the upcoming Silver Zones where feasible.

As part of efforts to raise awareness of the Silver Zone program, public engagement is of paramount importance. Engagement with the ground communities were carried through events, placing of banners, and distribution of Silver Zone collaterals which include posters, brochures and newsletter. The Silver Zone road safety enhancement schemes were also being consulted with the communities before implementation to ensure their continued support in shaping safer roads for all road users.

Apart from engineering aspect, good working relationship has also been fostered with the Traffic Police in the rolling out of the program.





Figure 6.247 – Examples of Narrowed Lanes

#### ○ KEY RESULTS/ACCOMPLISHMENTS

Based on the perception surveys conducted, residents and motorists within the vicinity of the Silver Zone in general welcome and support the new initiative, as they recognised the enhanced safety component.

Feedbacks received from the public to enquire and feedback about some minor traffic inconveniences related to the Silver Zone programme were mitigated by carrying out enhancements to the traffic schemes.

Operating speeds of the vehicles plying within the Silver Zone have been observed to generally reduce after the schemes have been implemented.

No.	Silver Zones	Before (km/h)	After (km/h)	Percentage Difference (%)
1	Bukit Merah View	31.0	27.9	-10
2	Jurong West Street 52	38.7	32.4	-16
3	Yishun Ring Road	49.0	47.0	-4
4	Bedok North Street 3, Ave 1 & Ave 2	42.0	31.0	-26
5	Marine Terrace & Crescent	36.3	28.1	-23
6	Tampines Street 11	39.3	43.8	11
7	Lengkok Bahru, Jalan Tiong & Redhill Road	35.0	33.0	-6

8	Woodlands Drive 14	40.6	36.0	-11
9	Hougang Avenue 5	41.0	31.2	-24

*Table 6.8 – Variation of the Operating Speed*

#### ○ POLICIES

New reduced speed limit of 40km/h is introduced to the identified Silver Zone and more traffic calming measures are introduced to the zones.

#### ○ BARRIERS/OBSTACLES

Due to the narrowed lane width and the need to still ensure accessibility of emergency vehicles, i.e. fire engines and ambulances, a new mountable kerb of reduced height has been introduced.

There were some confusions by the residents on the priority of users at the additional crossing points implemented. However, these confusions were subsequently clarified after engagement sessions with the stakeholders and the scheme has been revised to make the crossing more intuitive to provide clearer priority.

Striking a balance between road safety and traffic efficiency is not an easy task. Each Silver Zone design team took numerous traffic counts and detailed analysis to ensure that the best decision is made.

#### ○ LESSONS LEARNED

We noted that strong support from the communities in ensuring smooth implementation of Silver Zone programme is one of the key factor for success. Thus, we have reviewed the engagement processes to ensure that the processes being carried out earlier and more extensively.

Contacts

[koh\\_puay\\_ping@lta.gov.sg](mailto:koh_puay_ping@lta.gov.sg)

#### ○ REFERENCES

- [1] PIARC, “Human Factor guidelines for a safer man-road interface”, 2016R20EN

### 6.2.2.16. Introducing Traffic Calming Markings (TrCM)

○ COUNTRY

Singapore

○ IMPLEMENTATION ORGANIZATION

Land Transport Authority

○ SUBJECT

Setting Credible Speed Limits

○ PROJECT DESCRIPTION AND SUMMARY

This project entails utilising low cost measure (road markings) to create a visual narrowing effect to curb speeding at locations especially where physical traffic calming measures are deemed unsuitable. This is a psychological measure to overcome problems such as noise disturbance, damage to vehicles and discomfort to occupants while still retaining the capability of reducing vehicle speeds. TrCM encompass two parallel sets of jagged triangles pointing towards the road carriageway to visually narrow the road. The triangles also provide a “gripping” and funnelling visual effect when motorists approach the markings to encourage them to reduce their speed. These features serves to heighten motorists’ awareness on the need to be more alert and reduce their speed down. TrCM was first introduced as a trial at 3 locations in May 2008. It was subsequently expanded to a total of 11 locations.



*Figure 6.248 - Before and along bend scenerio for a TrCM trial location*

○ KEY RESULTS/ACCOMPLISHMENTS

Eight out of 11 trial locations showed a significant reduction in vehicular speed based on a ‘before and after speed’ study. Statistical tests performed at 95% confidence level also suggest the effectiveness of TrCM in speed reduction at the locations. It was also found that the potential of TrCM can be enhanced when used in combination with other natural road features such as a crest, a gentle bend or presence of road narrowing. However, it is less effective when applied along neutral road gradients or down slopes.

#### ○ POLICIES

As TrCM has proven as an effective measure to traffic calming, they can be used at sensitive locations (e.g. schools, residences, hospitals) where unwanted noises (due to vehicles applying brakes, or frictions) generated from physical traffic calming measures (e.g. humpare a concern to the residents. TrCM is also suitable to be provided where physical speed calming features are present as an additional speed reduction enhancement to the location.

#### ○ BARRIERS/OBSTACLES

Ignorance of motorists of the design intention of the markings are reduced with more applications and education and publicity in the media.

#### ○ LESSONS LEARNED

Psychological measures like TrCM can also be an effective and alternative measure to traffic calm the roads as compared to traditional physical measures such as speed regulating strips. The potential of TrCM can be maximised on the locations they are placed as mentioned in point 6. TrCM satisfies both type of environments (surrounding and operating) as it does not contribute to noise disturbance yet effective in addressing speeding issues. Nevertheless, physical measures are not to be discounted as they continue to serve as effective means of traffic calming. It is a matter of applying psychological measure to a situation in a holistic manner.

#### ○ COSTS

The approximate costs of providing TrCM is SGD6,000. This is the cost of painting the markings which does not include the costs such as road closure and providing alternative route, announcement via media to alert motorists as it varies from country to country as the operation/mobilisation costs are different.

#### ○ CONTACT

[Koh\\_puay\\_ping@lta.gov.sg](mailto:Koh_puay_ping@lta.gov.sg)

#### ○ REFERENCES

- [1] Ng, Y.W.J., Ho, S.T. and Palanisamy, C. (2013). An assessment of the effectiveness of Traffic calming markings and alternative for speed regulating strips. 16th Road Safety on Four Continents (RS4C) Conference, Beijing, China, 15 – 17 May 2013.



### 6.2.2.17. Introducing Broader Alignment Lane Markings (BALM)

- COUNTRY

Singapore

- IMPLEMENTATION ORGANIZATION

Land Transport Authority

- SUBJECT

The case study covers the Broader Alignment Lane Markings (BALM) which was first implemented in Singapore along two of our expressways in 2012. The scheme aims to use visual cues, instead of physical deflections, to act as a form of traffic calming measure.

- PROJECT DESCRIPTION AND SUMMARY

The Broader Alignment Lane Markings are a series of thicker lane markings painted along stretches of bends to encourage motorists to reduce their speeds and keep aligned to their respective lanes. They are usually implemented along expressways and major arterial roads where there is evidence of speeding, accidents or infrastructural damage and where physical traffic calming measures are not appropriate. The markings are more than twice the width and spaced closer apart compared to the normal lane markings. After the successful pilot in Mar 2012, BALM has been extended to 15 more locations.



Figure 6.249 - Before the intervention



*Figure 6.250 – After the intervention*

○ KEY RESULTS/ACCOMPLISHMENTS

Before/after studies have shown that the speeds of motorists have been reduced by up to 10 percent.

○ POLICIES

BALM has been published in Road Traffic Act.

○ BARRIERS/OBSTACLES

An obstacle that had to be overcome was the cost of treatment – thermoplastic paint is not cheap. Hence, locations for implementation had to be sieved out appropriately to ensure that BALM was implemented at areas in need of it the most.

○ LESSONS LEARNED

A key lesson learnt is that it is a misconception that all perceptual measures are ineffective. When applied appropriately, perceptual measures can be effective too.

○ COSTS

About SGD\$9,000/km/lane

○ CONTACT

Koh\_puay\_ping@lta.gov.sg

### 6.2.2.18. Increasing the safety depend on bad layout parameters

#### ○ COUNTRY

Slovakia

#### ○ IMPLEMENTATION ORGANIZATION

Slovak Road Administration, Region municipalities

#### ○ SUBJECT

The safety inspections on the 1<sup>st</sup> class roads in Slovakia were performed to identify safety problems, and consequently, proposals of the recommendations for traffic safety increasing. The inspections were oriented especially to the analysis of construction parameters, safety equipment, traffic signing, and pedestrian protection. Analysis of design parameters was focused on the bad layout parameters, an incorrect combination of the horizontal and vertical alignment, insufficient horizontal curve radius, and status of the intersections. The black spots were subject to the special assessment. The main problems detected were an inadequate horizontal and vertical alignments (Figure 6.251, Figure 6.252), an effect of the barrier near of the road (Figure 6.253), dangerous state of intersections from, etc. point of view (Figure 6.254). The measures to adjust the non-conforming condition included traffic signs and installation of the safety equipment in the first phase and construction measures (including rehabilitation of the pavement serviceability and reconstruction) in the second phase. The measures distinguished depending on locality (the rural or urban area) and terrain type. In the mountain terrain, the criteria respected an economic evaluation, too. The critical sections in the urban areas were recommended to solve only by traffic signs with respect to impossible demolition activities.



Figure 6.251 - Combination of the horizontal and vertical alignment and intersection





*Figure 6.252 - Combination of the horizontal and vertical alignment*



*Figure 6.253 - Width reduction by a barrier*



### ○ PROJECT DESCRIPTION AND SUMMARY

The case study presents problems of the bad layout with a combination of the intersection problems (crossing angle, sight distance). The previous situation shows Figure 6.254. The changes included a new design of vertical and horizontal layout, rebuilding the intersection from fork to the roundabout (Figure 6.255). The roundabout solved the problems mentioned above and improved the category width and new safety elements were added. The new design took into account also vulnerable road users, especially pedestrian. The project was realised last year and the current situation is shown in Figure 6.256, Figure 6.257.



Figure 6.254 - Combination layout and intersection – before intervention

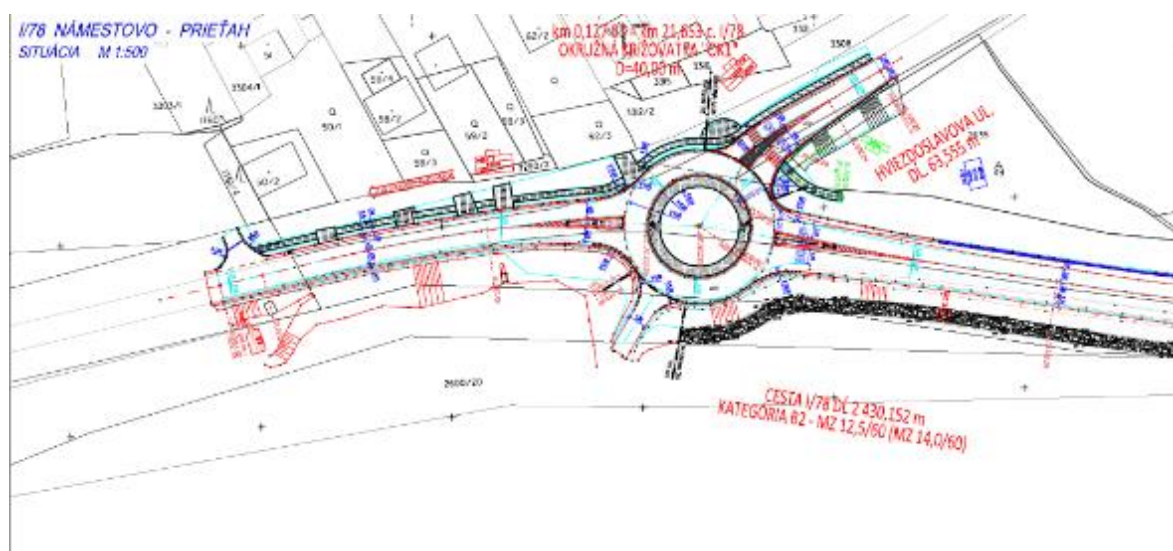

Figure 6.255 - Design of the rebuilding of the intersection



*Figure 6.256 - New layout and roundabout intersection – after intervention*



*Figure 6.257 - A new solution of the section – after intervention*

#### ○ KEY RESULTS/ACCOMPLISHMENTS

The key results were the simple project for traffic safety increasing on the analysed sections. The project of the section includes present conditions, the design of the new traffic signing (horizontal and vertical), the location of the new safety equipment (or renewal of inconvenient), the design of measures for pedestrian protection, the design of the pavement repairs (surface properties and bearing capacity). An incorrect road category was also solved by the enlargement in the frame of reconstruction. Slovak Road Administration accepted and approved the project and it was included in the budget for road reconstruction.

#### ○ BARRIERS/OBSTACLES

The basic barrier that is an inadequate budget for funding of the project proposal.

#### ○ LESSONS LEARNED

The key problem is very badly neglected maintenance during last 30 years. The pavement, safety equipment, bridges, drainage systems are in very bad state and jeopardize the traffic safety. Very

big part of the budget is necessary for elimination of the failures; there are results of insufficient maintenance.

○ COSTS

The cost of proposed measures resulting from safety inspections is approximately from 300 000 € to 4 mil. € per kilometre. The cost of the presented case study is not known because it was only a part of larger project.

○ CONTACTS

Jan Celko, Jozef Komacka, University of Zilina [Jan.celko@fstav.uniza.sk](mailto:Jan.celko@fstav.uniza.sk)

○ REFERENCES

- [1] Reports on Road Safety Inspection. USI, HAKOM 2016, 2017.
- [2] Design of measures on the basis of a road safety inspection carried out. University of Zilina, 2017, 2018.
- [3] Reconstruction of the road I/78 Namestovo. Woonerf, s.r.o., Hastra s.r.o.

### 6.2.2.19. Calming measure in town Podturn

○ COUNTRY

Slovenia

○ IMPLEMENTATION ORGANIZATION

Slovenian Infrastructure Agency

○ SUBJECT

The topic of this case study is dealing with speed management in town Podturn. The main problem was speed in the curve and in the near vicinity of a junction, where are also bus stops and school path to those two bus stops. People living nearby and alongside the road made several complaints to Municipality regarding the endangerment of their safety due to speedy vehicles and after Municipality's intervention to the Infrastructure Agency the problem is being tackled.



*Figure 6.258 – Site view before the intervention*

○ PROJECT DESCRIPTION AND SUMMARY

When receiving the information about the problem, we first went on the field to check the road and traffic. After traffic observation, we made a drive test with a car, to see what appropriate speed in the curve would be. After several times drive thru the curve, we have established that appropriate or »safe<sup>1</sup>« speed is between 35 km/h and 40 km/h. For drivers who are not familiar with the geometry of the road, the safe speed of 35 km/h is more than enough. For larger vehicles, the safe speed is approximately 30 km/h or less.

After setting the appropriate speed for the curve, we made speed measurements (before) to see what actual speeds on the road are.

---

<sup>1</sup> in accordance with the provisions of the Road Traffic Rules Act





Figure 6.259 – Site location from a top view

After getting the data of speeds thru the curve it was obvious that drivers tend to drive with inappropriate speeds, for which we can also fairly say that are not safe as well.

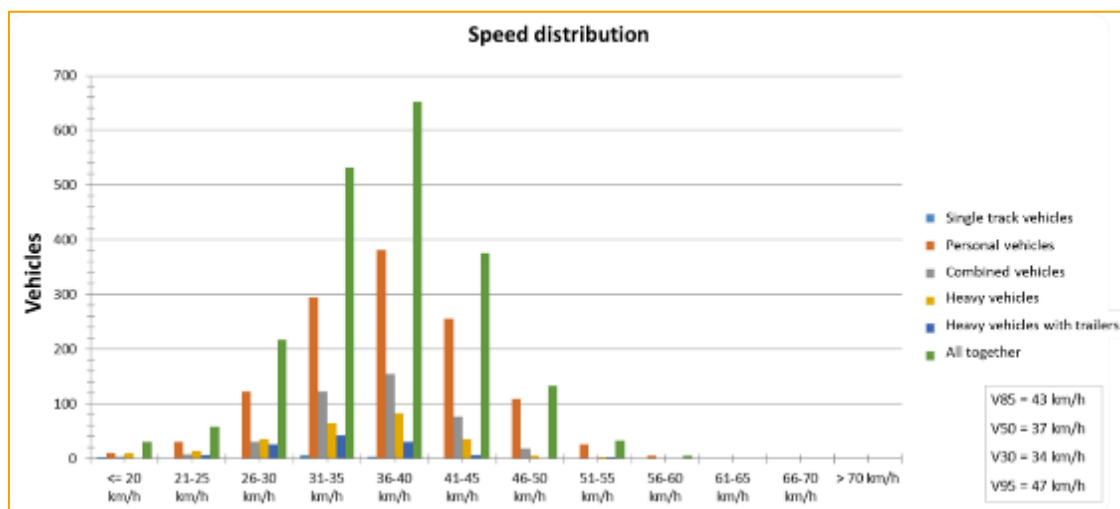

Graph 6.6 – Speed distribution before the intervention

We can see that 85<sup>th</sup> percentile of all vehicles (both directions) is 43 km/h, which is higher than with our test established appropriate speed, that was between 35 km/h and 40 km/h (up to 35 km/h for drivers who are not familiar with the geometry of the road, and up to 30 km/h for larger vehicles).

If we wanted to slow down the drivers (without construction intervention, e.g. road humps) we had to consider Human Factors knowledge in road design. After several considerations, we have decided to optically narrow the road with green colour made from cold plastic road marking material and optical traffic calming stripes. On the pavement (sidewalk) we marked colourful circles to emphasize present of pedestrians (especial school children on the way to and from bus stops). We also removed chevron signs that are used for marking the curves outside the cities, where higher speeds are present.

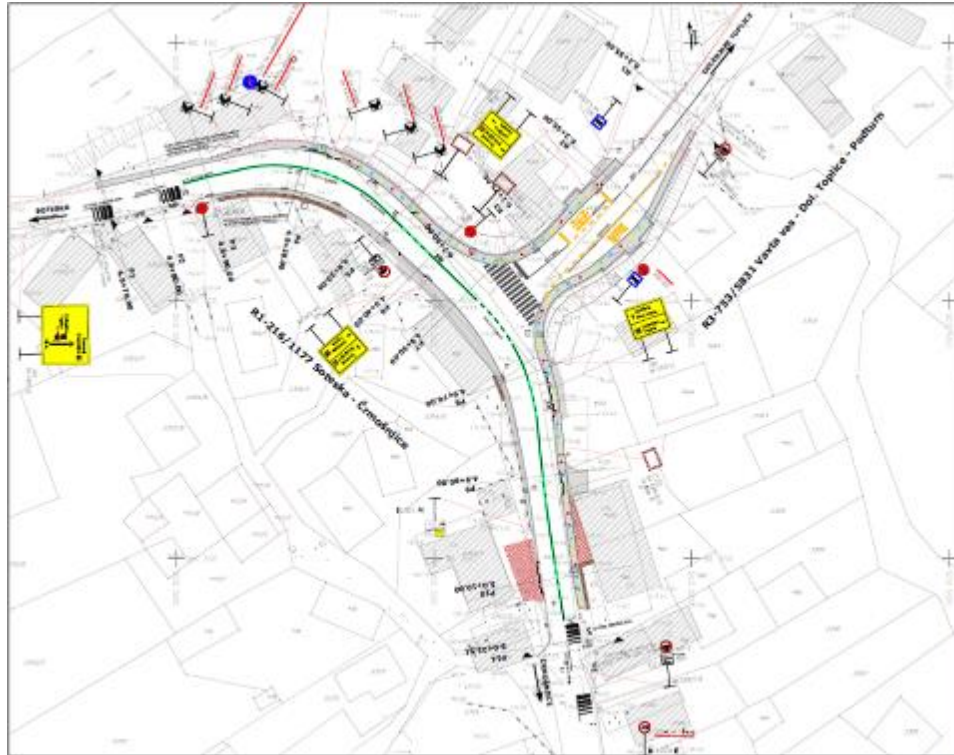

Figure 6.260 – Road signs location

From each direction, optical traffic calming stripes were set up before the curve and a junction and after that green contrast stripes were implemented for optical narrowing the road. Where individual road junctions (access to the house) are we just cut / brake the middle lane on the green contrast surface, as on the junction with other road we cut / brake the middle lane and the green contrast surface, to make it more conspicuous / obvious that there is an intersection.



Figure 6.261 – Site after the intervention, Direction A



Figure 6.262 – Site after the intervention, Direction B

After implementation of markings we waited for approximately 1 (one) month before we made another (after) speed measurements, as we didn't want the »boom<sup>2</sup>« effect to influence the measurements.

The after measurements were made at the same location and with the same device as before.

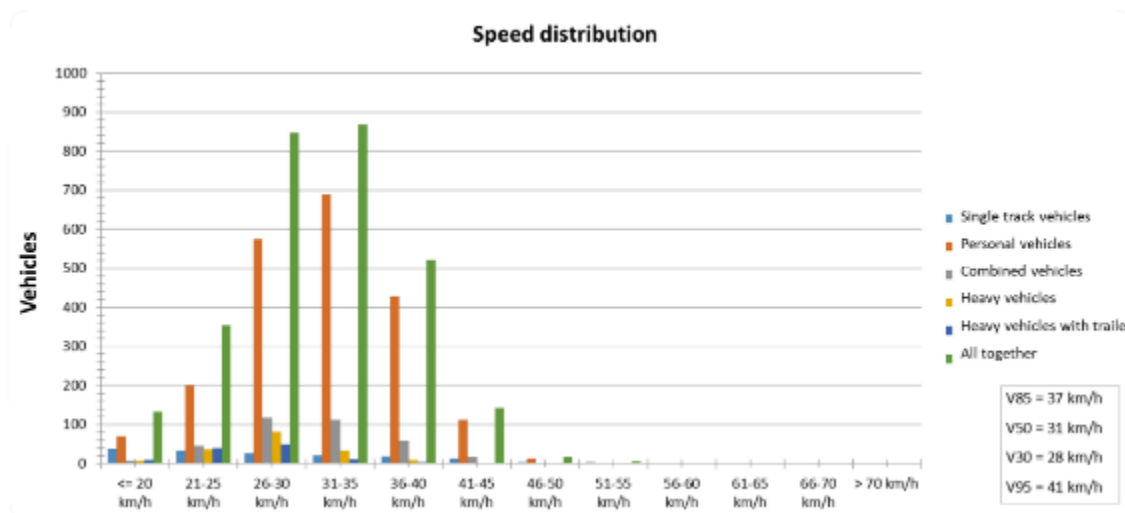

Graph 6.7 – Speed distribution after the intervention

In the after-speed measurements we can see that 85th percentile of all vehicles (both directions) is 37 km/h, which is according to our previously established appropriate speed (between 35 km/h and 40 km/h or up to 35 km/h for drivers who are not familiar with the geometry of the road, and up to 30 km/h for larger vehicles).

○ KEY RESULTS/ACCOMPLISHMENTS

With the implemented solution we are satisfied as it showed that with incorporating the Human Factors in the road design we can influence drivers' behaviour and it works as a speed management

<sup>2</sup> usually drivers promptly react to changes and after getting used to them, they tend to behave the same way as before the change

solution. So with the road re-design we managed to make road more self-explaining in the context of selecting appropriate (credible) speed and at the same time we enhance safety for vulnerable road users.

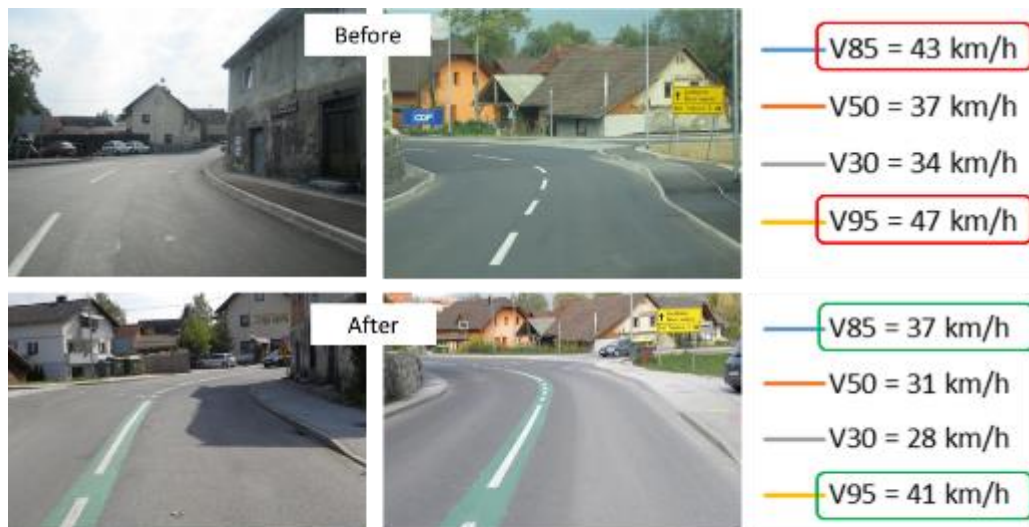

Total speed reduction for 6 km/h 😊

Figure 6.263 – Summary comparison between the site and the relative operating speed, before and after the intervention

#### ○ POLICIES

In the supplemented Roads Act in article covering traffic calming measures it is now allowed to use those kind of road designs (innovations).

#### ○ LESSONS LEARNED

Using Human Factors knowledge in road design should be more used, especially for speed management (setting credible speed limits) and for self-explanatory road design, so that the road would “talk” to drivers.

With that kind of road design, we can also tackle Drivers Distraction and Fatigue issues and of course provide better safety for all.

#### ○ COSTS

12.700 EUR

#### ○ CONTACT

[uros.brumec@gov.si](mailto:uros.brumec@gov.si)

#### ○ REFERENCES:

[1] WRA-PIARC Technical reports on Human Factors



### 6.2.2.20. Credible speed limit in Zone 30

#### ○ COUNTRY

Slovenia

#### ○ IMPLEMENTATION ORGANIZATION

Municipality Krško

#### Subject

With the new road design of a section of state road in town Krško, there was a need for new road design near the primary School. The basics for that need was the fact, that all the section of the road (within the town borders) was planned to be re-designed with similar features / design, that was existing road design near the School, where the zone 30 km/h was implemented, couple of years ago and it proven itself to work properly, considering the lower speeds, that is traffic calming and bicycle friendly road design. So, if the rest of the section of the road would look the same as School area, we would lose the credibility of road design in zone 30 km/h near the School.

#### ○ PROJECT DESCRIPTION AND SUMMARY

The object of the project (re-designing the zone 30 km/h near the School) was to implement new road design that would influence driver behaviour with lower speeds and more attentive driving and with that enhance road safety for vulnerable road users, especially for children walking and cycling to School.



Figure 6.264 – Before the intervention, Direction A

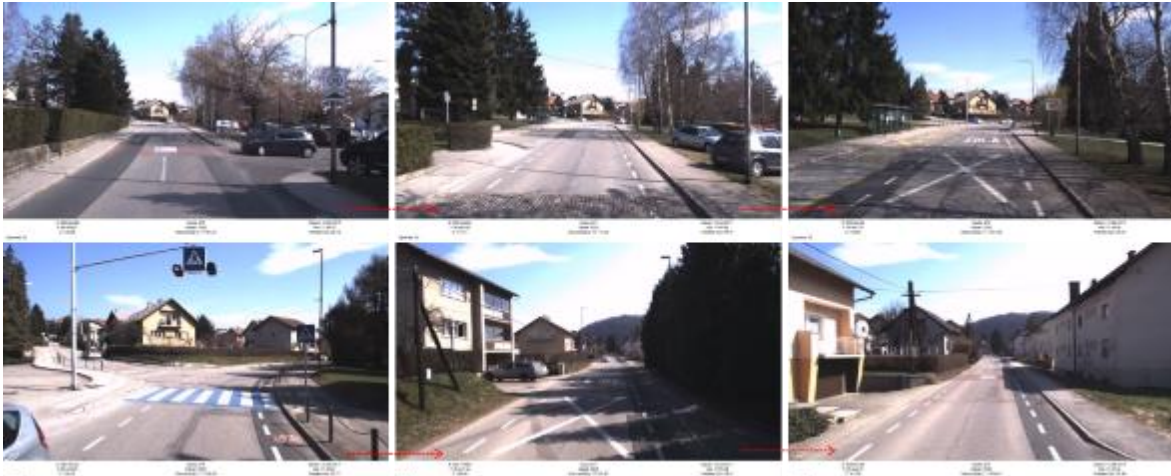

Figure 6.265 – Before the intervention, Direction B

In the picture above there is a road design before (from each direction) near the School, that is being transferred to the rest of the road section.

With close cooperation with design engineers, Municipality Krško and Infrastructure Agency the new design of zone 30 km/h was designed and implemented near the School.

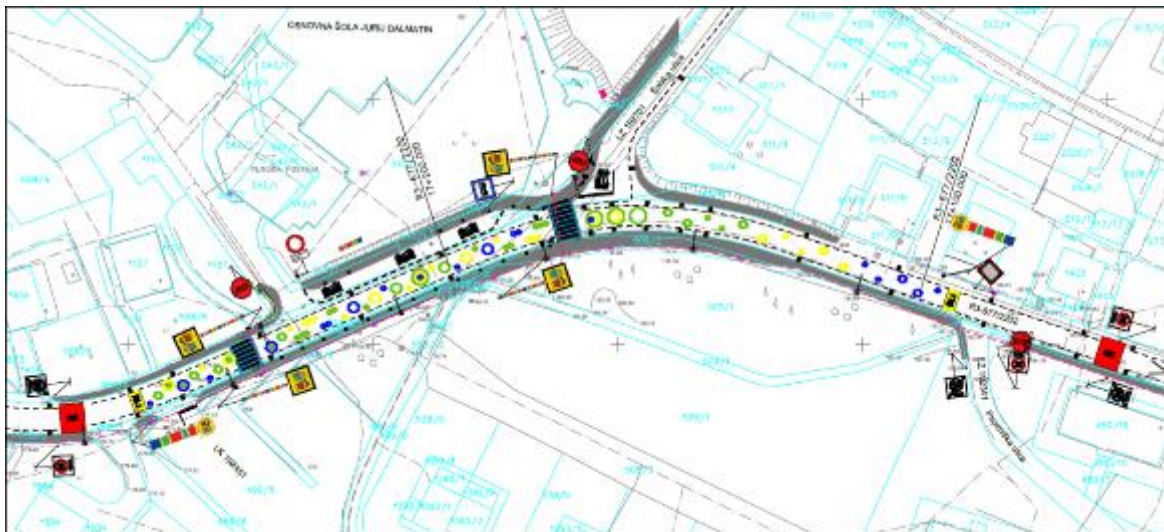

Figure 6.266 – Road Signs and special markings project

In pictures below there is new (after) road design, from both directions, near the School in the zone 30 km/h.



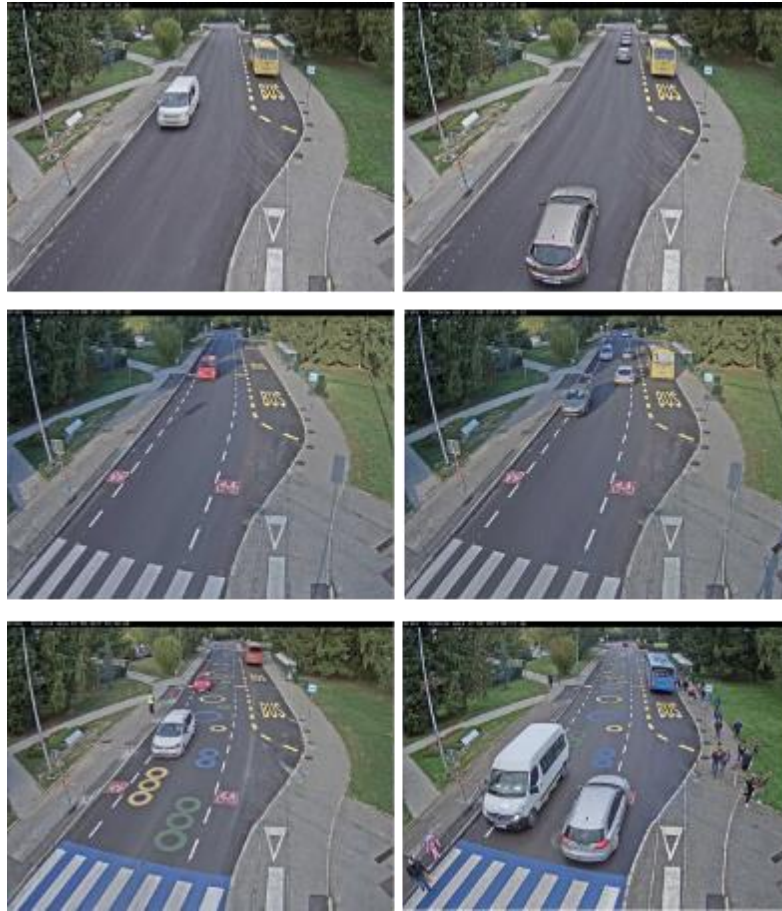

Figure 6.267 – After the intervention, Direction A



Figure 6.268 – After the intervention, Direction B

In addition, we monitored the traffic (how do drivers behave, due to colourful circles on the road), so that we would know what kind of impact do colourful circles have on drivers' behaviour and on driving, if any.



*Figure 6.269 – Road improvement steps*

After evaluation of before / after implementation of colourful road design, we came to conclusion that driving trajectories of vehicles did not change due to colourful circles on the road, so they do not pose any threat to drivers while operating the vehicle.

○ KEY RESULTS/ACCOMPLISHMENTS

After comparison before / after speed measurements it was recognised that road design influences on drivers' behaviour in the way they do reduce speed, as the design is credible considering the zone 30 km/h and the road is self-explaining, giving the drivers appropriate information regarding nearby School and presence of children as vulnerable road users (VRU's) on and alongside the road.





Figure 6.270 – Operating Speed analysis

In addition, we can see in the graphs that speed has reduced, also extremes and has moved to the left in the Gauss curve. 85<sup>th</sup> percentile speed was reduced for 4 km/h and max. speed in location 4 lowered for 6 km/h as in location 6 for 17 km/h.

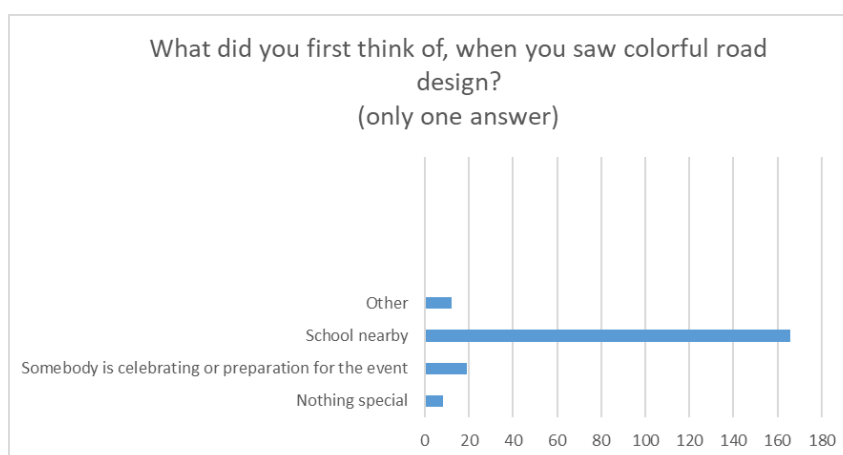

Graph 6.8 – Drivers survey 1

Also according to survey (205 drivers were surveyed; 61 men and 144 women) people understood road designed and did recognized it as self-explaining. Further drivers also tend to slow down (which was proven with the speed measurements) and are more attentive to children around the School. Furthermore people like the road design and would recommend it also for other Schools.

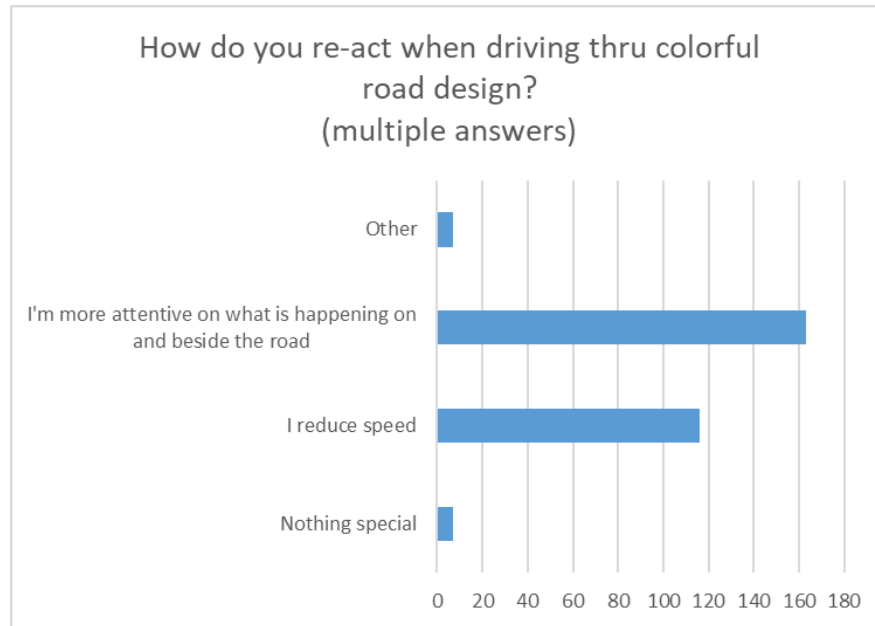

Graph 6.9 - Drivers survey 2

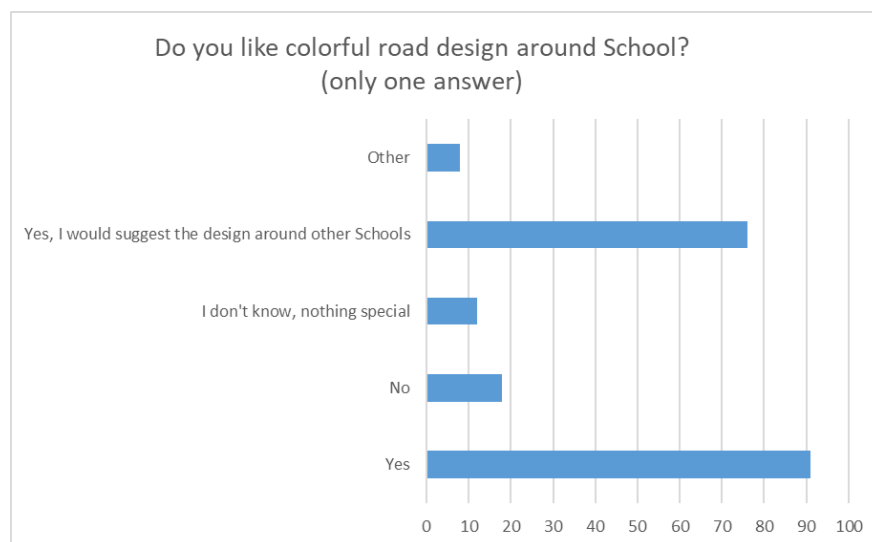

Graph 6.10 - Drivers survey 3

For conclusion, we can fairly say that the project is a success and has beneficial results on driver behaviour – speed and attention. With incorporating the Human Factors in the road design we achieved more credible speed limits and with that enhanced safety for VRU's.

#### ○ POLICIES

In the supplemented Roads Act in article covering traffic calming measures in is now allowed to use those kind of road designs (innovations).

#### ○ BARRIERS/OBSTACLES

Not really, except finding right road materials for road markings that are durable, do not pose noise problems (like rumble strips) and damage asphalt (are flexible enough considering shrinking of asphalt (summer/winter temperatures)).

- LESSONS LEARNED

Using Human Factors knowledge in road design should be more used, especially for speed management (setting credible speed limits) and for self-explanatory road design, so that the road would “talk” to drivers.

With that kind of road design, we can also tackle Drivers Distraction and Fatigue issues and of course provide better safety for all.

- COSTS

30.500 EUR

- CONTACT

[uros.brumec@gov.si](mailto:uros.brumec@gov.si)

### 6.2.2.21. Correction of alignment perspectives

#### ○ COUNTRY

Spain

#### ○ IMPLEMENTATION ORGANIZATION

General Road Directorate of Fomento Ministry

#### ○ SUBJECT

Problems due to false alignment perspectives are one of the most important problems detected in road safety studies. In these cases, configuration of road and its surroundings transmit to drivers a visual impression that, when it does not coincide with reality, it sometimes forces him to make sudden decisions (often hasty) that increase accident risk.

This situation occurs in different circumstances:

- Horizontal alignment changes
- Junction in which secondary road is in extension of the main road
- Sections where headlights of vehicles that circulate in near roads are visible at night. It can mislead drivers.

#### ○ PROJECT DESCRIPTION AND SUMMARY

Study evaluates improvement works get into service in several sections in the Spanish National Road Network which have these circumstances.

#### ○ KEY RESULTS/ACCOMPLISHMENTS

This chapter includes analyzed cases repeated more often and in which measures have been more effective to correct the identified problem. Moreover, cases in which accident rate has been decrease after the implementation of the works are considered too.

#### *Junction maintenance*

- One of the most common cases comes when apparent perspective transmits continuity driving forward in a case of loss of priority in “Y” junction (junction placed at an acute angle). This often occur when two roads of the junction have a similar range.
- This perspective produces two undesirable effects:
- One for the vehicle driving on the road which do not lose priority because it cannot be aware in last chance that is going to take the wrong way and finding itself forced to carry out a sudden manoeuvre to get back to the correct one. It can generate risky situations.
- The second effect is for the vehicles which are getting closer to the junction through a secondary road. They cannot be aware of the need to stop or to give way, being forced to brake abruptly or even going onto the priority carriageway.





Figure 6.271 - N-432 ordinary road. West junction of Llerena. Secondary road is in extension of the main road

- In these cases, the most effective solution is the conversion of the junction, increasing the angle between the two roads to the maximum possible. It is necessary try to achieve 90°, turning it into a “T” junction because this kind of junction do not generate misleading perspectives and each movement trajectory has a better appreciation.



Figure 6.272 - N-521 ordinary road. Current horizontal alignment of Malpartida junction (Cáceres)

*Plantations*

Sometimes, circumstances which produce the effect that distorts the road perspective cannot be solved by modifying the alignment. Furthermore, outside urban areas the route priority signing have not an easy understanding.

In these cases, solution adopted is the provision of a physical element which make a visual barrier and remove the misleading perspective. Physical elements that are most frequently used are plantations. A vegetable screen provision consists on shrubs arranged in the outside area of the platform (depending on the route elevation may be required to plant trees of a greater height). Other times, waste products from the excavation have been used to form a banked-up bed of lands that cover the view that produces undesirable effects



*Figure 6.273 - Disposition of a mound of land to eliminate continuity prospect*



*Figure 6.274 - Tree layout to eliminate front continuity prospect*

### Priority road signing

In urban areas, when situations of misleading perspective are given, in the most cases previous solutions cannot be applied due to the lack of space. In these cases, it has been shown useful the layout of signing called "Priority Route". It graphically indicates the road that maintains the right-of-way at a junction. At least, it compensates the visual effect of a perspective from the front.

Depending on section characteristics, these signing can be reinforced by settling delineators with leds, making them more visible at night.



Figure 6.275 - Priority road signing

### Antiglare Screens

- Another case in which misleading perspectives are produced, occurs at night when two road sections meet in parallel where vehicles headlights circulating in the other way do not permit correctly identify the path to be followed. It can even occur between the two carriageways of a same highway.
- In these cases, it has been widespread the use of antiglare screens. They are components placed over the safety barriers which hide the vision of the road section that is not desired to be seen by the driver. This component, placed at regular intervals, produces the same effect as a diaphragm wall that could be placed on the outer edges of the road. However, it has a lower cost.



Figure 6.276 - Anti-glare screen on metal safety barrier

#### ○ POLICIES

The conclusions of the study have not resulted in new road safety policies. The conclusions of this kind of measures have been included in several publications and manuals. These conclusions have even been presented at road safety conferences. These studies are useful as reference for road safety auditors or as solutions for specialists carrying out a high concentration accident section studies.

#### ○ BARRIERS/OBSTACLES

Execution of this kind of measures there have not been found obstacles that may be considered as significant, beyond the limitations of space that may arise in some cases, as mentioned before.

#### ○ LESSONS LEARNED

Generally, the solution to cases involving misleading alignment perspectives can be solved without changing the road alignment (high cost option). In this case, it is enough to insert any component that makes screen effect in the outside area of the carriageway, at a lower cost.

As a last instance, it may be used signing that although they do not prevent the misleading effect. However, signing is very useful to help driver to interpret the correct road alignment, even when the visual perspective may result in wrong interpretation.

#### ○ COSTS

Costs of this kind of measure depends on the characteristics of the section in which they are applied. The average values of each of them are:

- Junction maintenance (change from “Y” to “T”): 100,000.00 – 150,000.00 €
- Plantations (whole): 500.00-1.000.00 €
- Priority Route Signing (unit): 150.00 € (normal). 1,000.00 € (with reflecting leds)
- Antiglare Screens: 35.00€ (unit) 8,500 (average road section)

#### ○ CONTACTS

Roberto Llamas Rubio [rllamas@fomento.es](mailto:rllamas@fomento.es)



### 6.2.2.22. Sight improvements at intersections

#### ○ COUNTRY

Spain

#### ○ IMPLEMENTATION ORGANIZATION

General Road Directorate of Fomento Ministry

#### ○ SUBJECT

This case considers all junctions in which sight of vehicles which try to access it from the main road is limited by an obstacle.

In this case, it must be difference between two kinds of sight at junctions. On one hand, there is sight of a vehicle that wants to get main road from secondary one. It must be enough to let vehicle incorporate in optimum road safety conditions. So, this sight must let vehicles driving in the main road not to modify their speed because another vehicle takes this road from secondary road.

In case of “X” junctions, cross sight must be considered too. It is considered as distance necessary to see a vehicle driver when it is expected to cross a road that intersects its trajectory. It is measure across crossing road.

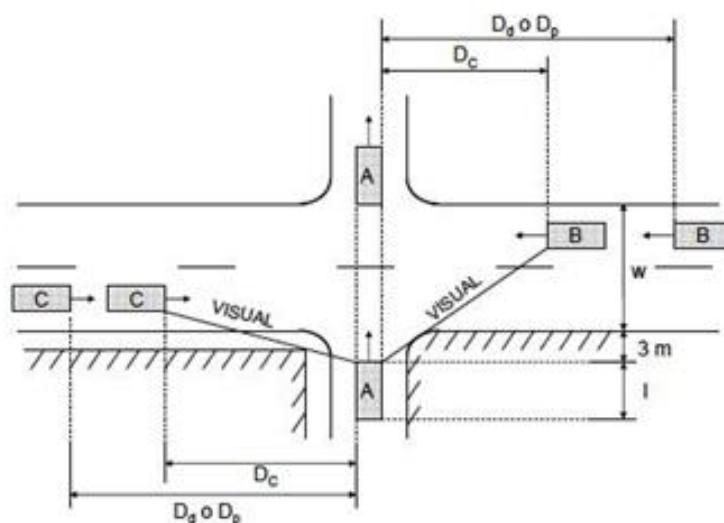

Figure 6.277 - Cross sight at “X” junctions

On the other hand, it can be considered sight of a vehicle which drive in the main road and approach to junction. It is called stopping sight and it is defined as existence distance between one vehicle and an obstacle sited in its trajectory (vehicle turn to the main road in junction) at the same time driver can see it without it disappear from driver visual area after that moment.

The most common obstacles in junctions are vegetation and cut slopes. Vegetation existence, depending on its height and density, can made junction not to have enough sight. Moreover, the same situation is produced by very vertical cut slopes with certain height.

#### ○ PROJECT DESCRIPTION AND SUMMARY

High concentration accident section studies carried out by Fomento Ministry conclude that accident rate in junctions is due to lack of sight.

As previously stated, the most commonly obstacles at junctions without enough sight are the vegetation and cut slopes.



*Figure 6.278 - Example. Junction without sight because cut slope*



*Figure 6.279 - Example. Lack of sight because vegetation*

Improvement measures for these situations are, on the one hand, site clearing not to be interrupted visual between junction and approaches in the main road. On the other hand, in the case of existence of very vertical cut slopes, the improvement measure consists on laying cut slope. That is, to decrease slope value to avoid it can be an obstacle in junction visual.

In addition, there may be another kind of obstacle that cannot be eliminated, either because it has not a feasible technical solution or because the cost of such elimination is too great. In these cases, the use of concave mirrors is very useful. This way, the sight of the vehicle that is to be incorporated into the main road from the junction is restored.

#### ○ KEY RESULTS/ACCOMPLISHMENTS

Junctions without enough sight, due to vegetation existence or cut slope disposition, in which some described improvement measures have been carries out (site clearing or laying cu slopes), show an accident rate decrease because reaches accidents have been reduced.



*Figure 6.280 - Example of site clearing to improve sight in curve*

In addition, because accident rate decrease, Fomento Ministry out site clearing campaigns, with special attention in junctions and their influence area.

Relating to laying cut slopes, accident rate reduction in junction where this measure has been carried out, has led to study this circumstance with special attention in road construction projects.

- POLICIES

In Fomento Ministry, road construction projects suffer a road safety audit to be approved. Relationship between the lack of sight at junction and a higher probability of road accidents (reaches between vehicles) has led to greater attention to this circumstance in road safety audits. So, road safety auditors review the possible existence of cut slopes whose slope may represent an obstacle to an adequate junction sight.

- BARRIERS/OBSTACLES

No technical or economic problems appeared during study periods or even after Technical Instruction publication.

- LESSONS LEARNED

On one hand, ordinary road maintenance (site clearing) become very important to keep road safety conditions in a high level.

On the other hand, it has also become aware that increase action budgets in road construction projects (laying cut slopes) results in a saving of social cost because it reduces accident rate and its associated costs.

- COSTS

In a junction: site clearing costs approximately 1,000€ and laying cut slopes is about 6,000€.

Cost of concave mirror installation is approximately 400.00€.

- CONTACTS

Roberto Llamas Rubio [rllamas@fomento.es](mailto:rllamas@fomento.es)

### 6.2.2.23. New Road Marking in the Federal Roads

#### ○ COUNTRY

United Arab Emirates

#### ○ ORGANIZATION

Ministry of Infrastructure Development

#### ○ SUBJECT

Execution of road marking to attract the attention of the drivers to a safety way of driving or to avoid traffic congestions in junctions which produces significantly dangerous segments.

The application of a special road marking in the road surface can attract the attention of the drivers to a better way to drive. Suggestions to attach to a safer driving can have effect on the people by applying safe and different road marking.

On the other hand and from the point of view of traffic control (impacting in the road safety) the traffic flow in junctions through congested areas can release the effect of creating accidents in the cars trying to incorporate to the main road

#### ○ PROJECT DESCRIPTION AND SUMMARY

Regarding the attraction of the drivers attention to a safer driving attitude, the MoID decided to execute two different measurements.

#### Smiley Faces

One of them has to do with the painting of a DRIVE SAFELY advise in the carriageway. The selected location to do that is one of the main corridors in the country (Road Sheikh Mohammed Bin Zayed, E311 in the border of the emirates of Ajman and Umm AlQuwain. The message pretends to warn the drivers and drive caring about the rest of the drivers, without speeding and keeping safe distance. Considering that the population is formed by a large amount of nationalities, it was decided to write the message in 3 languages: Arabic, English and Ordu to reach different massive sectors. This action pretends to have a positive psychological effect in the drivers. In this point SMILEY FACES were painted in the middle of the lane with the legend DRIVE SAFELY. The faces have 2.5m in the shortest axel and 4.2m in the longest one (parallel to the cars direction).



Figure 6.281 Multilingual motivational road marking for a safe driving. Sheikh Mohammed Bin Zayed Road (Umm Al Quwain). Detail 1.





Figure 6.282 - Multilingual motivational road marking for a safe driving. Sheikh Mohammed Bin Zayed Road (Umm Al Quwain). Detail 2



Figure 6.283 - Multilingual motivational road marking for a safe driving. Sheikh Mohammed Bin Zayed Road (Umm Al Quwain). Detail 3



Figure 6.284 - Multilingual motivational road marking for a safe driving. Sheikh Mohammed Bin Zayed Road (Umm Al Quwain). Detail 4



*Figure 6.285 - Multilingual motivational road marking for a safe driving. Sheikh Mohammed Bin Zayed Road (Umm Al Quwain). Detail 5*



*Figure 6.286 - Multilingual motivational road marking for a safe driving. Sheikh Mohammed Bin Zayed Road (Umm Al Quwain). Detail 6*

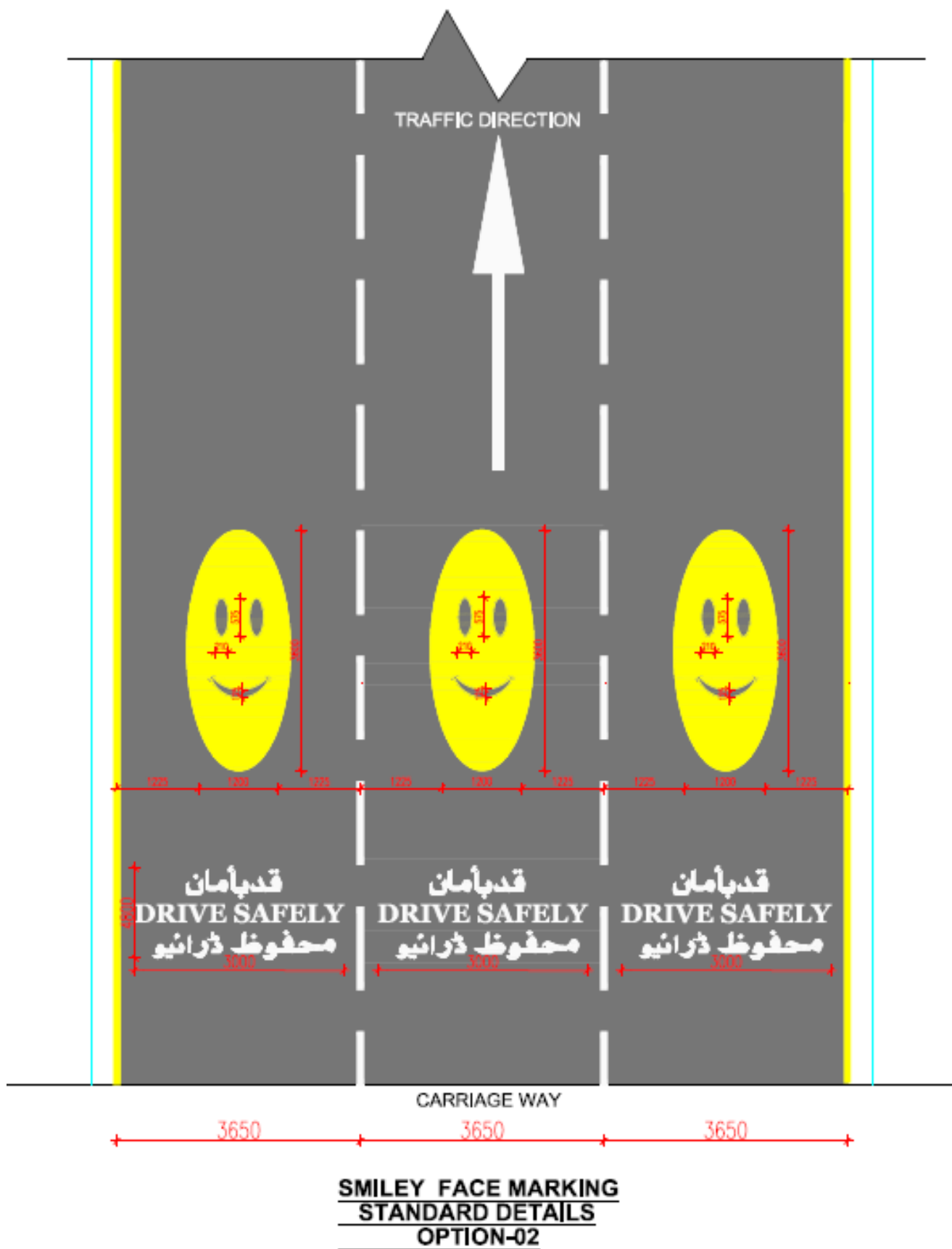

Figure 6.287 - Smiley faces Specifications

### White Dots

In order to keep enough safety distance between vehicles in the road, the installation of white dots in the middle of the lanes were painted. Signboards warning the drivers to keep at least 2 dots between cars (which makes a 100m distance) were installed. This way of measure the minimum distance can be easily detected by the drivers as well as police (for enforcement purposes).



*Figure 6.288 - White dots to keep safety distance. Sheikh Mohammed Bin Zayed Road (Umm Al Quwain). Detail 1*



*Figure 6.289 - White dots to keep safety distance. Sheikh Mohammed Bin Zayed Road (Umm Al Quwain). Detail 2*





Figure 6.290 - White dots to keep safety distance. Sheikh Mohammed Bin Zayed Road (Umm Al Quwain). Detail 3



Figure 6.291 - White dots to keep safety distance. Sheikh Mohammed Bin Zayed Road (Umm Al Quwain). Detail 4



Figure 6.292 - White dots to keep safety distance. Sheikh Mohammed Bin Zayed Road (Umm Al Quwain). Detail 5



Figure 6.293 - White dots to keep safety distance. Sheikh Mohammed Bin Zayed Road (Umm Al Quwain). Detail 6

This both measures were applied using cold paints in order to try this technology under the local conditions (traffic, weather, temperature, uv effect, etc). The results about this aspect after 2 years since they were applied are totally satisfactory.



### Yellow box

Another road marking action was implemented. This time with the objective to open the space between trucks (during the peak hours) in certain important junctions. Lack of these marks, make a continuous queue of trucks leaving null space for cars using the junction to go inside the road and to move to the middle and fast lanes of the highway. Vehicles incorporating to the main body of the highway did this manoeuvre without visibility creating really high probability accidents spots, by collision from the vehicles with higher speed using the carriageway. Currently the trucks using the slow lane can't invade those spaces unless they detect there is enough space for them to cross it. In this way lightest vehicles can cross fast those spaces to the main road and the trucks keep occupied the slow lane the same time. During the peak hours this lane can accumulate more than 500 trucks during the same period crossing at least 3 intersections of this type. Sensation of safer driving is present in these points at that time.



Figure 6.296 - Yellow marks to avoid invasion of heavy vehicles when having traffic jam in the slow lane (increasing of safety from drivers coming from the link road). Detail 1

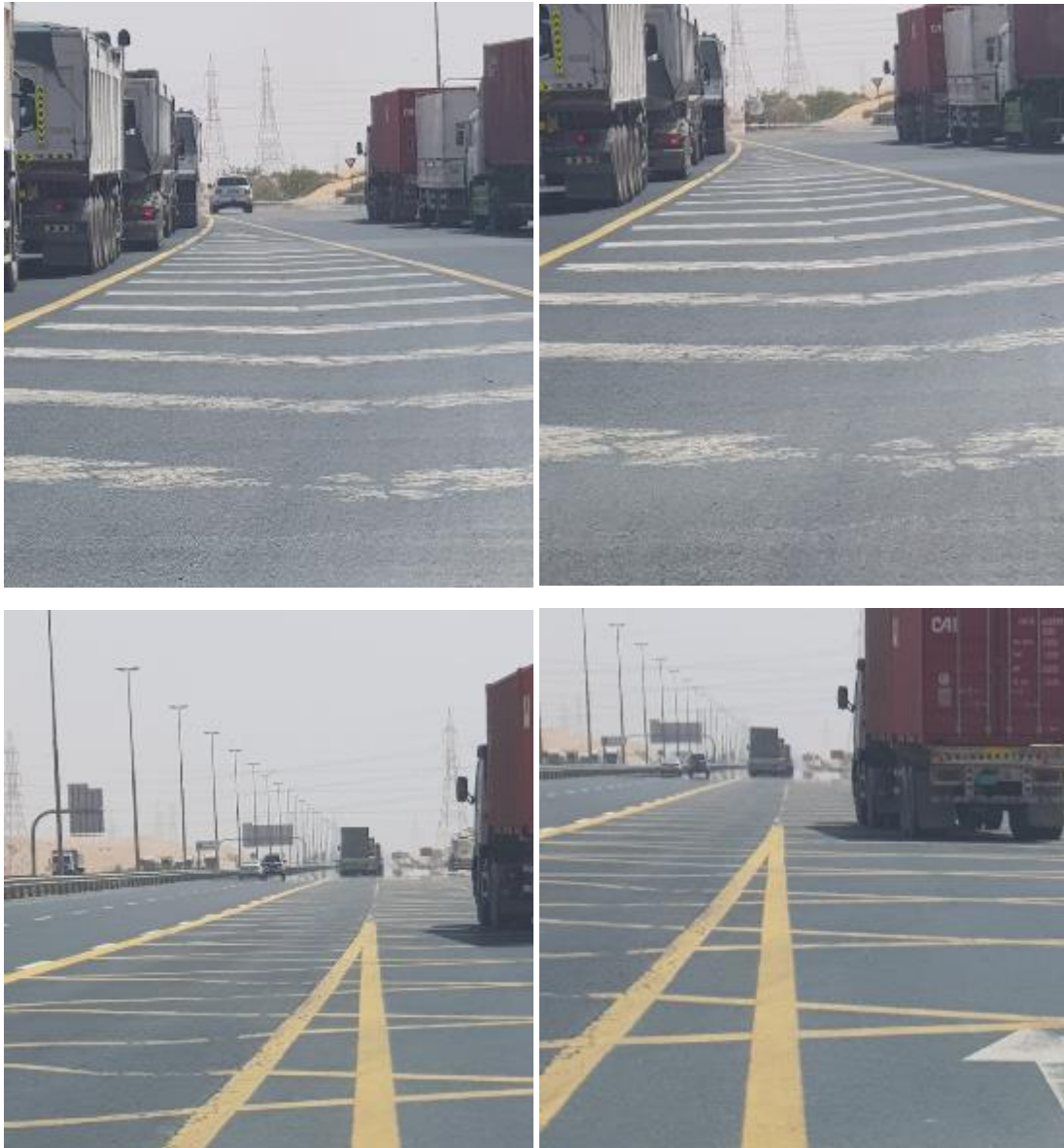



Figure 6.297 - Yellow marks to avoid invasion of heavy vehicles when having traffic jam in the slow lane (increasing of safety from drivers coming from the link road). Detail 2



Figure 6.298 - Yellow marks to avoid invasion of heavy vehicles when having traffic jam in the slow lane (increasing of safety from drivers coming from the link road). Detail 3



*Figure 6.299 - Yellow marks to avoid invasion of heavy vehicles when having traffic jam in the slow lane (increasing of safety from drivers coming from the link road). Detail 4*



*Figure 6.300 - Yellow marks to avoid invasion of heavy vehicles when having traffic jam in the slow lane (increasing of safety from drivers coming from the link road). Detail 5*

#### ○ KEY RESULTS AND ACCOMPLISHMENTS

Since only these actions were taken related to road safety in those segments, the reduction of incidents and accidents during the past period (since the installation until September 2018) can be considered an effect on the drivers. These actions can be extrapolated to the rest of the network, looking for a same response and a similar effect.

Ministry of interior of UAE has recognized these developments and some other Administrations have started to apply something similar.

UAE is a country where user satisfaction is a very important parameter to measure the quality of the government administrations' work. Implementing any action related to improve the services will always be well appreciated by most of the users.

Since these elements are new applied in the roads, we still need to collect information from the different police departments to compare accidents before and after (in time) and compare them within the segments where we painted the roads.

However, our expectations in road safety improvements expressed in % of accidents reduction in those segments, are approximately:

- Smiley faces contribution: 2 to 3%
- White dots: 4 to 5.5%
- Yellow boxes: 6 to 7%

### ○ POLICIES

Ministry of Infrastructure Development following the National Policies of development and safety decided to try these actions in the roads to follow the objectives related to the National Agenda, Vision 2021 and the Zero Accidents goal.

### ○ BARRIERS / OBSTACLES

Without any doubt the main obstacle during the execution of these works is the operative traffic on the road. More than 20,000 vehicles per day make any maintenance and operation activity difficult to coordinate and to execute. However police support was basic for these activities and was always offered in fast way. Operatively the MoID relayed as well activities for traffic management in the current Maintenance Contractor (doing the works based on performance contract, in which one of the main points has to do with helping on organizing traffic management tasks)

### ○ LESSONS LEARNED

Application of well planned activities related to traffic safety have real and good effect in the final result for accidents improve.

- Good acceptance from the users and appreciation for the Ministry work related to traffic safety
- Call attention for the users using different road marking (which is not distractive and obstructive) seems to be a good solution to increase the safer driving
- Cold plastic materials seem to be susceptible to be applied for these uses
- Keeping distance between vehicles to allow other vehicles to incorporate to the main road have immediate and visible positive effects in the road safety conditions

### ○ CONTACT

Daniel Llorc Mac Donald, Ministry of Infrastructure Development UAE, +971.56.26.12.489, [daniel.llort@moid.gov.ae](mailto:daniel.llort@moid.gov.ae)

Yousef Yahya, Ministry of Infrastructure Development UAE, +971.50.30.41.834, [Yousef.Yehya@moid.gov.ae](mailto:Yousef.Yehya@moid.gov.ae)

Shafia Alkheyaili, Ministry of Infrastructure Development UAE, +971.52.707.0001, [Shafia.Alkheyaili@moid.gov.ae](mailto:Shafia.Alkheyaili@moid.gov.ae)

David Berrocal Benito, Rauros Middle East, +971.56.17.15.268, [dberrocal@raurosme.com](mailto:dberrocal@raurosme.com)



### 6.2.3. Case Studies dealing with the Driver Expectation Rule of the Human Factors principles

#### 6.2.3.1. Road infrastructure: visual elements leading to a coherence between driver expectancies and driver behaviours

##### ○ COUNTRY

France

##### ○ IMPLEMENTATION ORGANIZATION

Cerema Normandy-Center, based in Rouen (France)

##### ○ SUBJECT

The case study deals with the interaction between the driver and the road environment, more specially, what are the road visual elements used by the drivers in order to know the regulatory speed limit as well as to choose their driving speed. The idea is to rely on the results in order to work on the road environment, in a self-explaining road logic, in order to:

- naturally incite drivers to adapt their driving behaviours to each situation whether it is in terms of speed or lateral position,
- provide them with a consistent road environment in terms of speed limit and design. Consistency allows the matching between drivers' expectancies as to driving situation met and their driving behaviours. Consequently, this consistency of road environment could lead to make rules that result respectable/credible then accepted and complied.

##### ○ PROJECT DESCRIPTION AND SUMMARY

To drive safely the driver must mainly solve a spatio-temporal problem in order to control his trajectory (i.e., lateral position and speed) and to adjust it to changes in environment, mainly from visual informations. These are provided by the road elements such as road signs, road marking, and allow drivers to adapt their driving with the driving situation met. However, the correct course of the perception process appears to be important as 90% of crashes result from human errors (Wegman, 2007) which, in part, are due to a misreading of the road environment and/or a failure in visual information processing. These failures can result from a lack of understanding of the road environment and/or its complexity, which could result from inconsistency between the driver's expectancies and driving situation met.

The failure, for example, to respect speed limits could have the layout of the road infrastructure as origin:

- It could not allow to the driver to recognize the road type (i.e., motorway, divided rural road) consequently driver could not know the currently speed limit without a speed limit sign,
- it could allow to the driver to recognize the road type certainly but the currently speed limit does not match with the driver's expectancies in reference with the road type recognized and the highway code. Then, without a speed limit sign, driver could not practice the regulatory speed limit.

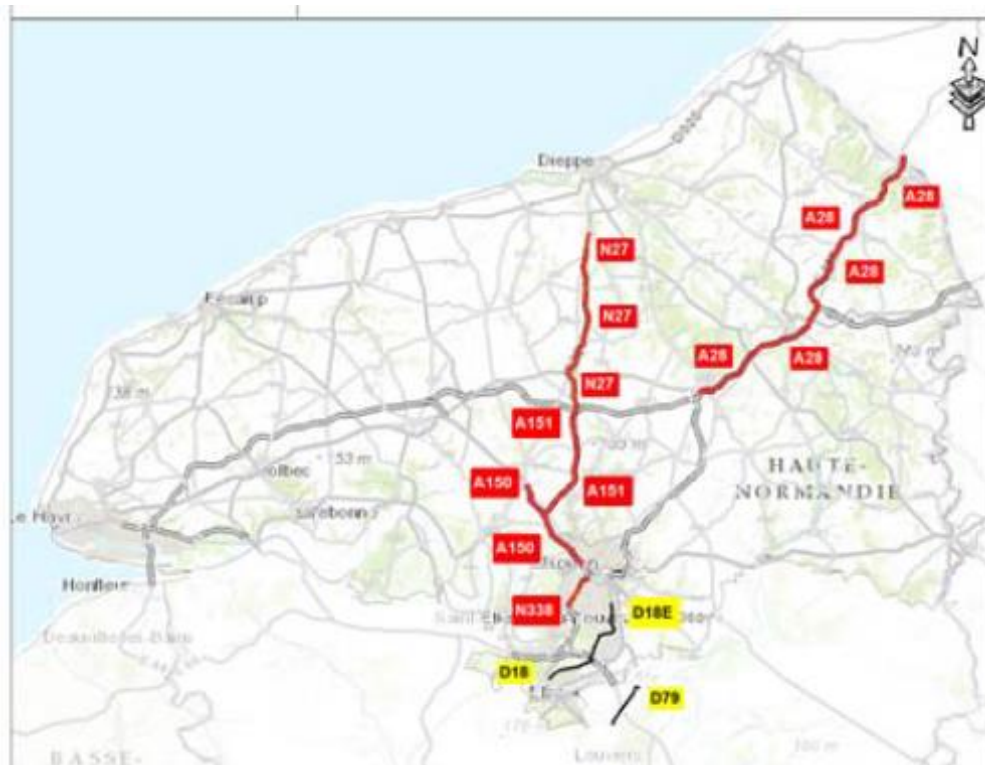

Figure 6.301 - View of the network on which the videos have been recorded (Motorways – A reference, divided highways – N reference and rural roads – D reference). In France, the speed limit is 130 km/h on the Motorways, 110 km/h on divided highways (motorways are excluded) and 90 km/h on undivided roads.



Figure 6.302 - Example of pictures with ambiguities (at left) and of an inconsistent situation (at right). At left, on the lower picture, the ambiguity has been obtained by deleting the town sign. At right, the inconsistency results of the fact that the drivers enter on motorway (motorway sign) with 90 km/h speed limit.



*Figure 6.303 - View of the digital camera (canon EOS 60D) used to make videos from where the pictures have been extracted. A black protection has been placed on dashboard in order to minimize reflections.*

In this context, in 2013, 44 participants completed a questionnaire showing 73 photos of real sections of motorways (21 photos), divided highways (39 photos, motorways are excluded) and undivided rural roads (13 photos). The aim was to determine the road elements from which drivers base their speed choice.

The results showed that the participants based their speed choices on their road categorization. This road categorization resulted in corrected speed choice (i.e., it is consistent with the speed limit in situ) for the undivided rural roads (90km/h) and the motorways (130km/h). For the divided highways (motorways are excluded), despite their correct road categorization, the participants are reluctant between 90, 110 and 130km/h. They attribute 130km/h to what appears characteristic of a motorway (e.g, A sign – A standing for motorway in France, road sign with blue background...) or to large crossing profile (e.g., good visibility, open landscapes...). The other sections were associated with a 110km/h speed excepted when urban elements or a narrowed roadway were present, then the 90km/h speed was associated.

#### ○ KEY RESULTS/ACCOMPLISHMENTS

The drivers rely their speed choices on their recognizing of road types. They are correct for the motorways and undivided rural roads, but for the divided highways (i.e., motorways are excluded) the failures are more numerous. We assume that these failures result from the road environment variety which associated with divided highways such as rural, urban, suburban, large vs narrowed roadway, etc..

The speed limit should be set according to the consistency principle between road infrastructure, road environment and this setting of speed limit in order to limit as much as possible discrepancies

between drivers' expectancies and the visual information provided by road infrastructure. Discrepancies that can lead to a speed choice not adapted to the driving situation met and/or not complied with the speed limit.

From these results, we assume that the drivers have expectancies in terms of speed limit, behaviours of the other road users, occurrence of events rely on their recognizing of road type.

These results underline the importance in road safety to put road user back at the center of the system. Furthermore, they can represent a first step to make recommendations for the road operators in order to:

- - identify inconsistent zones, sections and remedy the situation in terms of speed limit,
- - be aware of these expectancies in elaborations of countermeasures. Indeed, the introduction of discrepancies and/or inconsistencies can surprise drivers and lead to errors that increase crash risk.
- To conclude, the application fields of the results are both inconsistency of relationship road users and road, and the speed management.

○ COSTS

Low cost

○ CONTACT

[Florence.rosey@cerema.fr](mailto:Florence.rosey@cerema.fr)

○ REFERENCES

- [1] Gibson, J.J., 1986. The Ecological Approach to Visual Perception. Lawrence Erlbaum Associates, Inc., Hillsdale, NJ. (Original work published 1979).
- [2] Turvey, M.T., 1992. Affordances and prospective control: an outline of the ontology. *Ecol. Psychol.* 4, 173–187.
- [3] Wegman, F., 2007. Road Traffic in the Netherlands: Relatively Safe but not Safe Enough! Improving Traffic Safety Culture in the United States: The Journey Forward, April 2007, AAA Foundation for Traffic Safety. <[http:// www.aaafoundation.org/pdf/Wegman.pdf](http://www.aaafoundation.org/pdf/Wegman.pdf)>.



### 6.2.3.2. Human Factors Countermeasures in a fatal accident curve

#### ○ COUNTRY

Germany

#### ○ IMPLEMENTATION ORGANIZATION

Verkehrsunfallkommission des Landkreises Märkisch-Oderland, Land Brandenburg, Germany

#### ○ SUBJECT

In Germany, Brandenburg, a sharp accident curve with inconsistent radius has been investigated to clarify the possibilities of effective countermeasures to avoid fatal accidents. The curve is located in a sag without sufficient perceptibility from the approaching sections. The sharpness of the curve is not reliable predictable for drivers because radius is decreasing and after the top of the curve increasing.

Several countermeasures to prevent accidents were insufficient and without results. It would be recommendable to reconstruct the curve. But private use on the one roadside and a nature reserve on the other roadside made it impossible to reconstruct the curve. That's why a team of engineers and Human Factors specialists tried to develop optical low cost countermeasures.

#### ○ PROJECT DESCRIPTION AND SUMMARY

In a field experiment engineers and psychologists together observed the driving behavior in dependence of the height of an optical guiding frame in the outer curve. Best results were achieved with an optical guiding frame 2.75 m above ground with alternating yellow-orange colours of different length that work additionally like an optical break.



*Figure 6.304 - Optical guiding frame in a curve with fatal accidents with integrated optical break (source: Birth, S., Demgensky, B. & Wähler, U., 2016)*

There was a pre-post design developed to investigate the speed before and after the installation of the optical break. The first measurement was taken instantly before the installation in 2010 (blue line), the second after the installation 2010 (green line). The speed drops down in average by 15

km/h. The highest speed falls off from 80 km/h to 55 km/h without any signing. The speed was significant lower after the installation of the outer frame that works like an optical break.

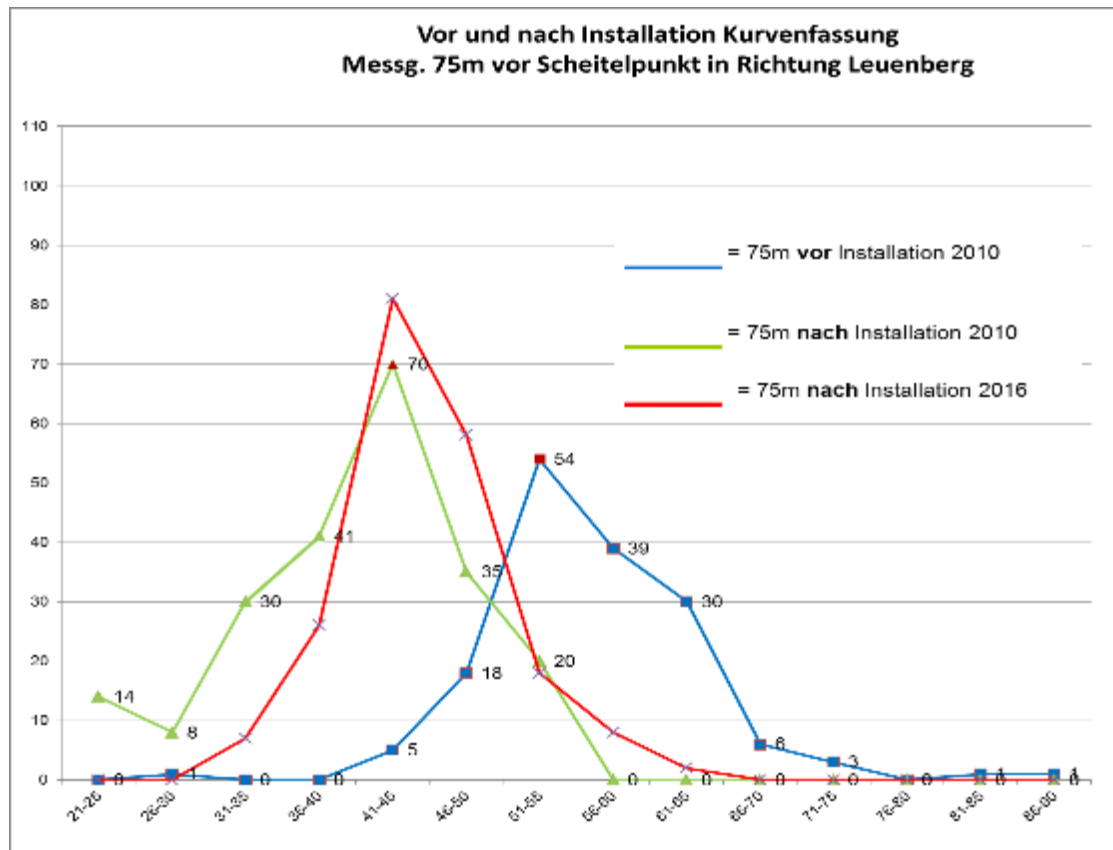

*Graph 6.11 - Significant speed reduction before and after the Human Factors Intervention (source: Birth, S., Demgensky, B. & Wähler, U., 2016)*

In 2016 there was conducted a reliability test again to check if the speed reduction works also four years after the installation. The results are very clear. Even four years after the speed is significant below the level of 2010 (red line).

Because of the little amount of severe accidents it was not possible to proof the significance of the fact that the number of severe accidents also decreases: In the years 2006-2010 (before installation) 9 severe accidents occur; in the years from 2010-2016 (after the installation) 6 severe accidents occur. But in sum the overall number of accidents before and after the intervention showed a significant reduction from 26 accidents before and 17 accidents after the intervention (error probability 5%).

#### ○ KEY RESULTS/ACCOMPLISHMENTS

- The collaboration of engineers, road safety specialists of the accident commission and Human Factors specialists provides a great benefit in developing effective countermeasures to prevent accidents even if measures has long time shown no effect.
- A precondition for the successful cooperation of the specialists of divers faculties is a basic knowledge about Human Factors in road safety.

- The significant reduction of accidents from 26 before and 17 after the Human Factors intervention gives a strong prove for the effectiveness of the framing of outer curves with integrated optical break as Human Factors countermeasures
- The stable speed reduction of in average 15 km/h over 4 years shows: the very often assumed temporary speed reduction by Human Factors countermeasures has to be proved. It rather seems to be depended on the specific situation if optical breaks and signals have a long lasting effect on drivers behavior.
- If the reconstruction of an accident spot is not possible for various reasons – the low cost HF-solutions can help to prevent accidents until the favorable construction is possible.

#### ○ POLICIES

The countermeasure goes far beyond the regulations of the German standards and it was necessary to get a special permission for this pilot-project. The standards point out that a sufficient optical guidance is needed, but without clear specification how to realize that in such a long lasting accident spot. Until now only normal chevrons can be used to mark the outer curve and the efficiency of optical breaks is neglected.

However, the results support the intensive discussion concerning the Human Factors in Germany.

#### ○ BARRIERS/OBSTACLES

See under policies

#### ○ LESSONS LEARNED

If road construction and design parameters are not sufficient for a safe design, it is always the question if Human Factors countermeasures are a way to prevent accidents. The first priority – however – should be a reliable and safe road design to avoid accidents.

If this is not possible, then special Human Factors countermeasures can awake attention, prepare and instruct the driver and improve his driving performance under difficult circumstances.

If this is not possible, try to improve the situation with better marking and signing. If this is not effective the process has to be evaluated and started again.

#### ○ COSTS

In this case a sum of 65.000 Euro was needed for the construction of the optical guiding frame with integrated optical break, including the costs for the scientific concept and study. For the reconstruction of the accident bend were estimated already 6.5 Mio. Euro – despite the fact of the missing possibilities of building land.

#### ○ CONTACTS

Dr. Sibylle Birth, Babette Demgensky,

Intelligenz System Transfer GmbH

Freiheitsr. 124-126, 15745 Wildau

[intelligenz@ist-potsdam.de](mailto:intelligenz@ist-potsdam.de)

Uwe Wähler

Straßenverkehrsamt

FD Verkehrsorganisation

Märkische Straße 2, 15344 Strausberg

Telefon: 03346-8507100

[Waehner@landkreismol.de](mailto:Waehner@landkreismol.de)

○ REFERENCES

- [1] Birth, S., Demgensky, B. & Wähner, U., 2016. Bericht zur Evaluation der Wirksamkeit einer optischen Bremse auf Geschwindigkeit und Unfallgeschehen 2010 – 2016 auf der B 158/A130 Leuenberger Grund. Report für die Unfallkommission Märkisch-Oderland. Strausberg.



### 6.2.3.3. Safer Way to School

#### ○ COUNTRY

Slovenia

#### ○ IMPLEMENTATION ORGANIZATION

Pilot project for Master's Thesis, later adopted by Slovenian Infrastructure Agency and Municipalities for implementation on state and municipality roads

#### ○ SUBJECT

In Slovenia, there is not yet a harmonized strategy and with that directive or guidance how to deal with school paths and vicinity of schools alongside roads (consequence of poor spatial planning and land use / urbanism), so Pilot project aim was to make and to introduce low cost solution, without construction intervention (prompt measures), using good practice and Human Factors knowledge in Road Design, and with that improve road safety from infrastructure pillar of UN Decade of Action for Road Safety. The aim of the project was to implement safe(er) School and Kindergarten area on municipality road by introducing Human Factors in to the road (re)design. The pilot project could be used to learn (find potential defectiveness and find improvements), for further "best practice" implementations on Slovenian roads and background for legislative part (1st pillar) and potential guidance how to deal with those kind of problems (linear settlements and schools alongside roads).

Location, suitable for pilot project, was defined together with municipality of Žalec, taking into the consideration road safety issues around schools and the location of schools. As majority of schools are situated in urban areas with traffic calming measures and reduced speed limit "Zone 30", we defined School and Kindergarten Trje, to be most appropriate for the project, as it is outside urban area, with set up speed limit of 50 km/h.



Figure 6.305: Location of School and Kindergarten alongside the road and direction of travel

When driving on the road (in the vicinity of school and kindergarten Trje), driver does not get proper information that School and Kindergarten is nearby and with that also children as vulnerable road users (VRU) to be present on the road. Drivers in transit do not expect that School and Kindergarten will be situated outside the town, while ones who are familiar with the location of School and Kindergarten (the locals) pay a little attention to it, as they drive by daily in automated driving mode (daydreaming etc.). So the existing road design is not very self-explaining. We could say that road does not speak to the drivers and therefore they are not attentive to potential danger – children on the road.

### ○ PROJECT DESCRIPTION AND SUMMARY

First information was gathered from school, where pupils actually walk. After receiving all the information, designing of the solution took place in the way, that road will “talk to drivers” by its design – “be aware of children”. Information signs and markings were designed, in user friendly way, to talk to drivers and stimulating them to be more attentive of children on the road and at the same time encourage them to drive with more caution.

In close vicinity of School and Kindergarten junction, where there are also bus-stops and a pedestrian crossing, special totems were set up and colourful bollards.

Traffic signage, urban equipment and markings were carefully designed and put into place considering the road alignment and roadside environment.

All equipment (especially bollards) was carefully chosen so that in the case of impact they do not pose additional threat to road users. Passive safety is also important when designing this kind of safety solutions.

In addition, self-explaining information signs were set up at the beginning from each direction of travel towards the School and Kindergarten. From information signs, all the way to School and Kindergarten where pupils walk to and from School, and kindergarten children take their daily stroll, colourful circles, with additional anti-skid elements, were marked on the pavement, as shown in figures 3 and 5 below. Circles were separated apart (raster / distance between them), so that children could not play on the pavement, by jumping from one circle to another.



*Figure 6.306: Information signs*

In near vicinity of school (near pedestrian crossing, bus-stops and junction to school), totems were set up, with colourful bollards as shown in figure 4. Also red colour surfaces before the junction were applied and pedestrian crossing was made on blue contrast surface (figure 5 and 6). Existing traffic signs were replaced with new ones and repositioned on more suitable locations. Also some traffic signs (for pedestrian crossing and bus-stop) were made with yellow fluorescent background, to be more conspicuous.



*Figure 6.307: Pavement markings (blue and yellow circles)*



*Figure 6.308: Totem with colourful bollards*



*Figure 6.309: Colourful bollards, red surface before the school junction with colourful circles on the pavement*



Figure 6.310: Pedestrian crossing on blue contrast and new traffic sign

#### ○ KEY RESULTS/ACCOMPLISHMENTS

The design was very well accepted among children, parents, teachers, local community and drivers. The idea behind the design and its purpose was to alert drivers, to properly stimulate them to be more attentive for children presence and to reduce speed.

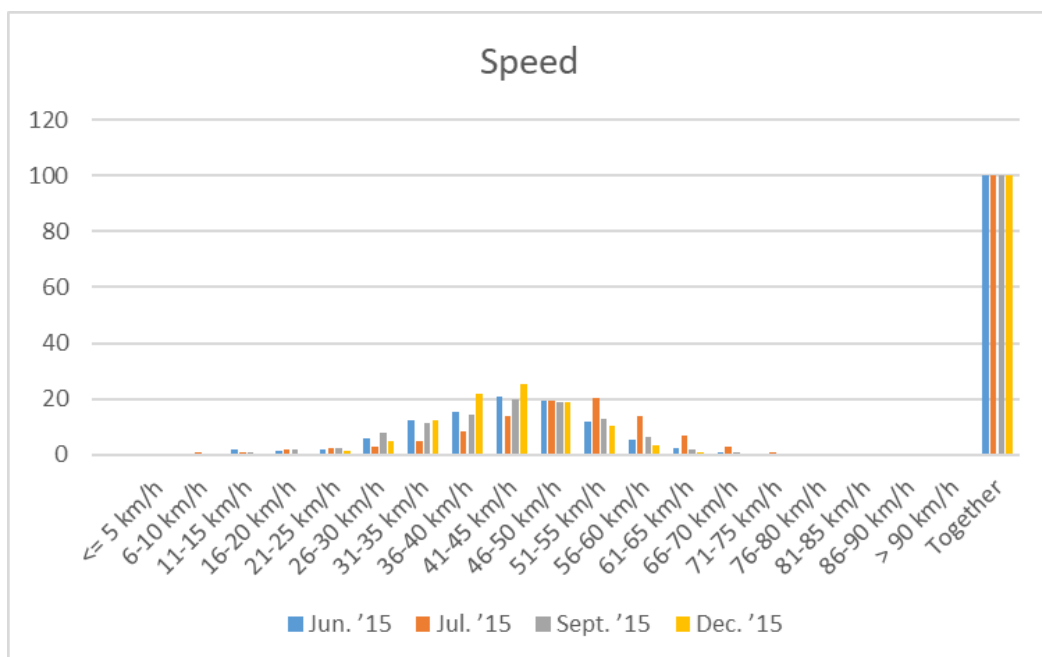

Graph 6.12 - Speed monitoring (before/after)

Speed monitoring (before/after) was also carried out, with Traffic data collection of traffic volume and speeds (ViaCount II). I monitored speed before the project:

- June '15 (during School),
- July '15 (School-brake),
- September '15 (beginning of School),

and after the project implementation:



- December '15 (during School).

Monitoring was done in similar weather and road conditions, so the weather and the road surface did not affect the driving speed.

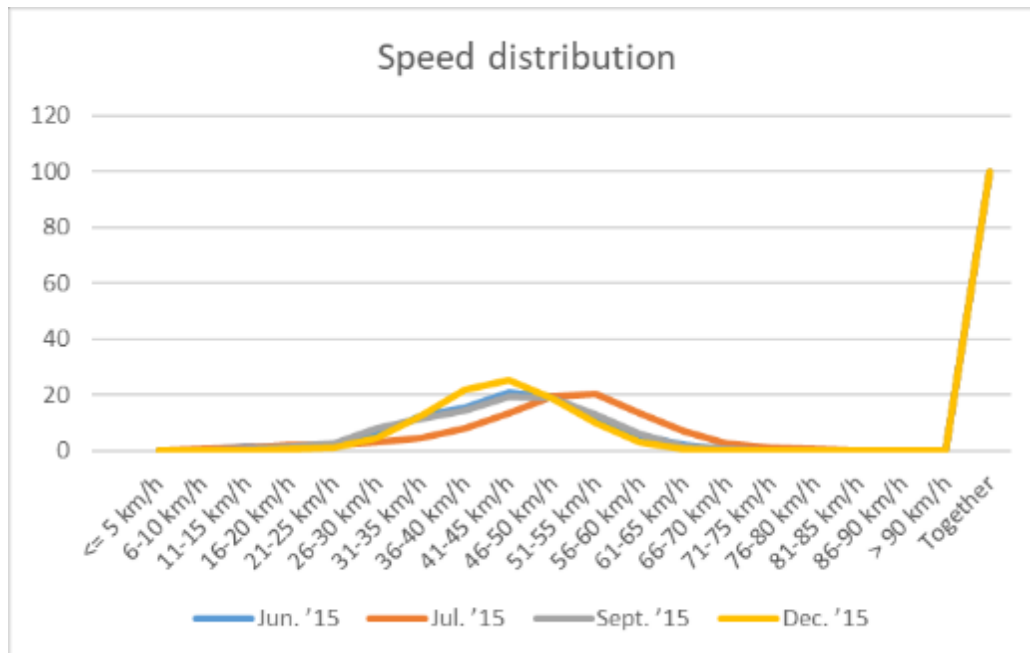

Graph 6.13 - Speed distribution (before/after)

When analysing the speeds, we came to the conclusion that after the project implementation, speeds were lower and also extremes, those who were driving way over the speed limit, has been reduced. Also those who were driving before within the speed limit (50 km/h), they drove between 46 km/h and 50 km/h and now, after the project implementation, there speeds come down between 40 km/h and 45 km/h. It also can be seen that the curve of the normal distribution (Gaussian distribution), in Graph 6.13, has moved to the left in December '15 (after the project design was implemented and in practice for over a month).

Alongside the speed monitoring the survey was carried out, with a desire to get answers if drivers understood the colourful road design, its purpose, and how do they re-act upon that. We wanted to know if design is enough "Self-explaining", do drivers know, that the School is near and therefore presence of children, and do drivers become more attentive, more alert, for children presence.

The survey was carried out in the local community and 131 replies came back.

According to Slovenian regulations, the driver beginner (young driver) is driver until the age of 21 years or driver who has driving license up to 2 years, for older drivers are considered those of age more than 64 years, and in between those two categories are "other" drivers.

Looking at answers from Graph 6.14, the colourful road design is understandable, as drivers did understand the meaning of the design and that is about School, Kindergarten and School path – presence of children. So, self-explanatory of the design was confirmed.

From Graph 6.15 answers, we can see that self-explanatory road design has a positive effect on drivers' behaviour. They tend to be more attentive, more alert, of what is happening on or beside the road – more watchful for children and they slow down, as was also confirmed by speed monitoring.

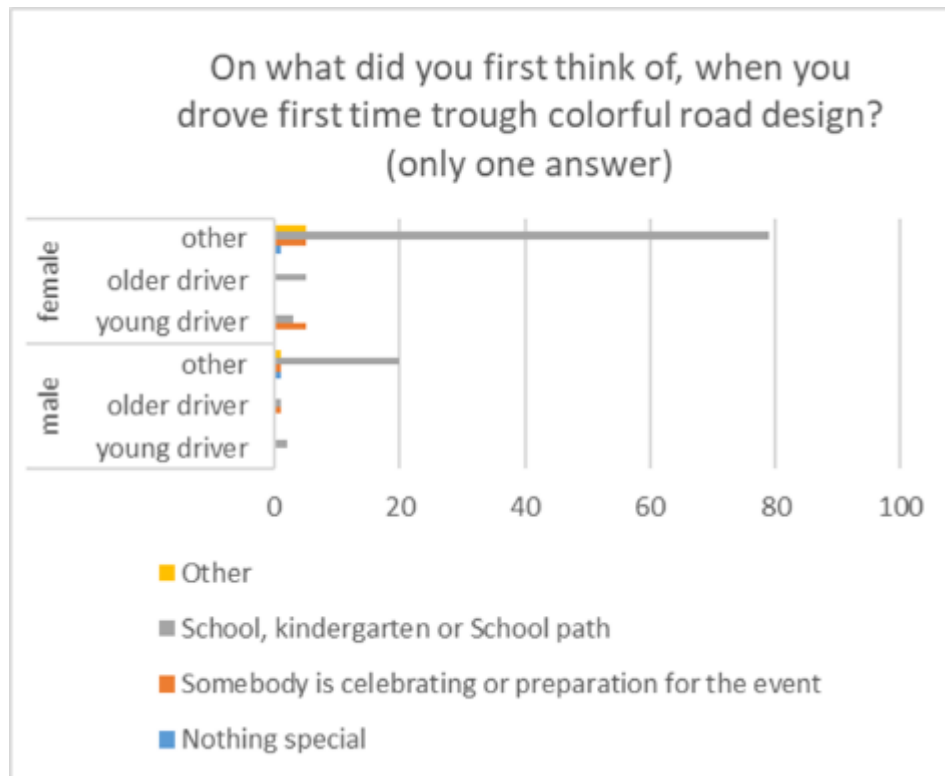

Graph 6.14 - Question about "Self-Explanatory" road design

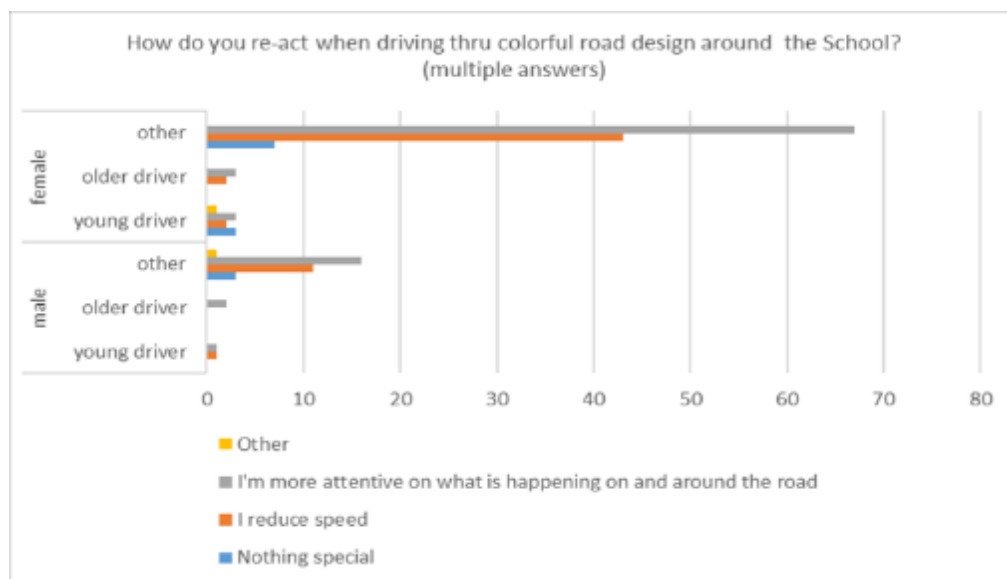

Graph 6.15 - Question regarding drivers' re-action

Again, answers about the likability, acceptance, of the colourful road design, in Graph 6.16, are positive. Drivers do like and accept it, and they recommend it, for further usage around vicinity of other Schools and Kindergartens.

For conclusion, we can fairly say that the project is a success and has beneficial results on driver behaviour – speed and attention.

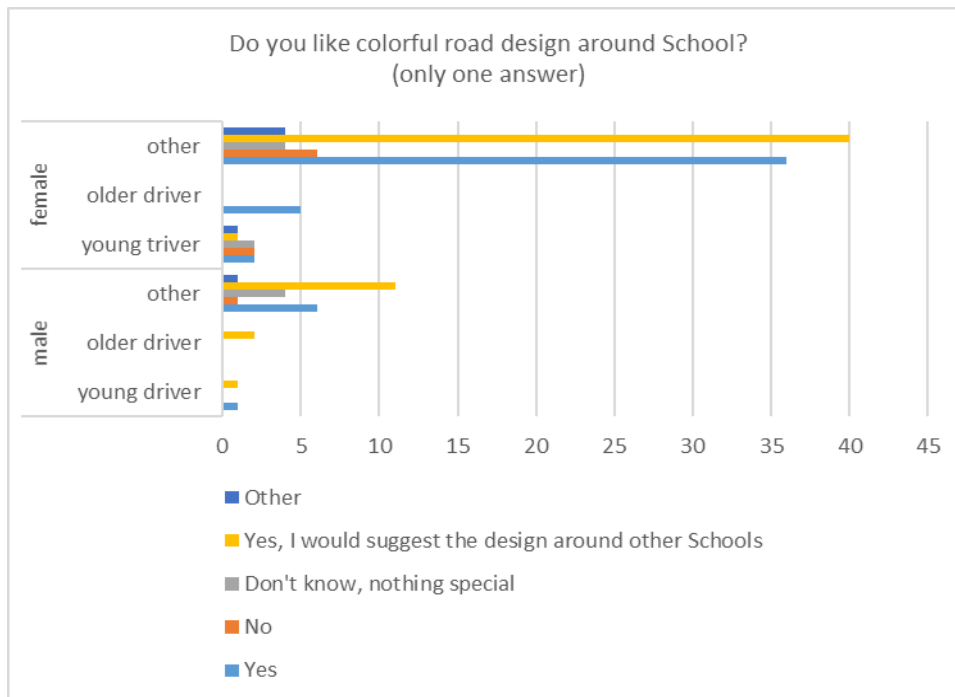

Graph 6.16 - Question about likability of the colourful design

By thoughtful incorporation of Human Factors knowledge in to the road design, we can enhance Road Safety, and at the same time tackle nowadays ever-growing problem on drivers' Distraction and Fatigue.

#### ○ POLICIES

Yes. Slovenian Infrastructure Agency recognised the solution as effective considering problems of inadequate spatial planning and urbanism and ever-growing problems in traffic regarding drivers' Distraction and Fatigue. So the design was adopted by the Agency and is starting for brother implementation on state roads, tackling speed management and attention of drivers while driving thru School areas and where School Children walk. Also promotion campaign is scheduled thru this year for awareness and education purposes.

Also in Roads Act (when it was supplemented) the act covering innovation / pilot project was changed in a way that pilot projects (good practice) can be easily implemented on state roads and consequently other regulations covering roads.

#### ○ BARRIERS/OBSTACLES

Considering the legislation, the road re-design could not be drastically changed, as we did not want to make the solution legislative litigable, and also some budgeted restrictions had to be considered as pilot project was supported by the companies (donors), who decided to do the work "pro-bono".

The main problem was, finding the right products for the solution. As this was a pilot project, a lot of improvising had to be done, to find the right materials and products for the solution. We had to use materials / products that were available to me by the product range of the donors.

Special problem was finding the right materials for totems and bollards as well designing the right dimensions and raster between colorful circles on the pavement.

### ○ LESSONS LEARNED

The most important lesson is: “Where there is a will, there is a way!”, meaning even if there is a legislative barrier, we have an obligation to promote and implement good practice solutions on our roads and even change legislation if needed.

Of course the solutions must be well thought thru with understanding of Human Factors in Road Design and after implementation also monitored and evaluated.

### ○ COSTS

The overall costs for the pilot project were hi, as a lot of man hours went in (brain storming and finding right solutions, including some tests before implementation, work and material), so overall costs for designing and implementing the projects are estimated on 37.582,71 EUR.

### ○ CONTACT

Uroš Brumec, Slovenian Infrastructure Agency ([uros.brumec@gov.si](mailto:uros.brumec@gov.si))

Twitter: [https://twitter.com/ Safe to School](https://twitter.com/Safe_to_School)

LinkedIn: <https://lnkd.in/Y5sZqR>

Youtube: <https://www.youtube.com/channel/UC9DtYTYweWw4oWsNO8wQq1g>

### ○ PHOTOS



*Figure 6.311 - Day / night visibility of information sign, totem and bollards*





Figure 6.312 - Colorful road environment near the junction to School



Figure 6.313 - Official opening day of pilot project



Figure 6.314 - Drawings from kindergarten children and their and their parents statements (like: "My mommy said, she will drive more slowly now", "We as pedestrians must watch out as well, if some savage driver drives by", "Bollards are here, so that the car will drive slowly" ...)



Figure 6.315 - Drawings from school children





*Figure 6.316 - Colorful bollards with School and Kindergarten behind*

#### 6.2.3.4. Countermeasures in areas with risk of rear end collisions

○ COUNTRY

Spain

○ IMPLEMENTATION ORGANIZATION

General Road Directorate of Fomento Ministry

○ SUBJECT

This case usually appears in some of the road sections in which, for different reasons, there is an abnormally high number of road collision accidents between vehicles.

The most common road section where this type of accident is recorded is on high capacity roads with high traffic intensity, in urban areas or close to them, where at certain times of day (or on specific days such as operations departing from vacation) retentions occur. The generated retention queues produce decreases in the speed of circulation (and even the complete cessation of circulatory flow). So, depending on the available visibility or the attention they provide when driving some drivers, they do not have time to brake and stop the vehicle without colliding with those that precede it.

This situation is also common on conventional roads at the entrance to urban areas. In this areas, drivers must adapt the speed of their vehicles to the new environment (the maximum regulatory speed in the city is 50 km/h) and even stop at a traffic light or for the existence of a pedestrian crossing.

Finally, another usual case of this type of traffic accident are sections with a high ascending longitudinal slope (normally higher than 5%) in which the speed of some heavy vehicles is significantly reduced. As consequence, powerful light vehicles cannot maintain its speed or even cannot reduce it slightly if a very slowly vehicle are circulating. So, depending on their driver attention, drivers can be surprised by a slow vehicle and do not have time to brake to avoid reaching it from behind.

Current normative in Spain includes the installation of a vertical signing. It is called P-31 vertical signing, "Congestion". It indicates "danger due to the proximity of a section in which traffic is stopped or hindered by traffic congestion". However, there is nothing more about circumstances in which it must be used.



Figure 6.317 - P-31 vertical sign, "Congestion"

P-31 vertical signing is usually accompanied by a restriction vertical signing called R-300 "Minimum separation". It is defined to "prohibit driving without maintaining a separation equal to or greater than that indicated in the signal with the preceding vehicle, except to overtake. If it appears without the indication in meters, it has to be remembered that, in general, the safety distance between vehicles established by regulation must be kept". Indication includes in the Spanish Circulation



General Regulations says that “every driver of a vehicle traveling behind another must leave a space between them that allows them to stop, in case of sudden braking, without colliding with it, taking into account especially the speed and the conditions of grip and braking”.



Figure 6.318 - R-300 vertical sign, “Minimum separation”

Anyway, the use of these vertical signing is not directly linked to the situations described, so it is necessary to establish specific measures for sections with high risk of accident by scope.

#### ○ PROJECT DESCRIPTION AND SUMMARY

Vertical signing reinforcement was tested in some sections of National Road Network where road collision accidents between vehicles occurred frequently (some of them were identified as high accident concentration sections). Selected sections were sections with a high ascending longitudinal slope or large length in which, depending vehicle weight/power ratio, vehicles decelerated progressively until reaching what is known as "sustained ramp speed". The main target was verifying if a specific signing was more effective than a general one in described situations. The first option was to provide the signal type P-31 accompanied by a complementary board with "SCOPE" word located at the bottom (in Spanish “ALCANCES”). It highlights the specific risk that the signal intends warn.



Figure 6.319 - A-3 high way, kilometer point 316 (Valencia). P-31 vertical sign with complementary board

Another option was the use of advertising boards with yellow background with high retroreflectivity. They included specific messages or intuitive drawings characterizing the kind of accident whose risk one wanted to warn about. There are not a standardized design, so it is possible to find different boards with similar designs and contents but different from each other. Some examples are the following ones:



Figure 6.320 - N-340 road, kilometre point 854 (Valencia). Advertising board



Figure 6.321 - A-5 highway. Miravete defile (Cáceres)

These boards were effective in the most of studied cases. There, not only traffic accidents were reduced, even circulation speeds.

It occurred at the same time as appear observations of several European countries (France and Portugal) that had previously incorporated safety clearance chevrons. General Traffic Directorate of Demark established them in 2009 with positive effects. It was possible to reduce speed between 1 and 3 km/h and even this horizontal signing effect extended between 1 and 4 km before its position. However, in this case the effect is smaller. This effect disappeared between 7 and 12 km before this horizontal signing position.

Consequently, homogenization of this kind of horizontal signing was necessary, so standards and designs were established.

○ KEY RESULTS/ACCOMPLISHMENTS

The established distance between chevrons depending on the maximum speed allowed in the section to ensure that a driver circulates at an adequate distance from the vehicle that precedes. This distance must allow to reduce speed to adapt to a particular circumstance without having to stop, considering the time of perception and reaction necessary for it. It is guaranteed when two chevrons are observed in the gap with respect to the previous vehicle.

Safety distance between chevrons is established in meters as the product of the maximum speed established by 0.85 and rounded to the multiple of 5 higher. There will be a minimum number of 10. They will be arranged in the center of the lane with the vertex towards the direction of circulation. It is shown in Figure 6.322.

After the studies carried out, and in accordance with current regulations (General Circulation Regulation), signing in the tunnels with scope risk was particularized. In this case, signing indicates specific safety conditions for trucks in order to serious consequences that could have a traffic accident involving this kind of vehicles. Safety distance is guaranteed when the driver can see three chevrons and not the two indicated above.

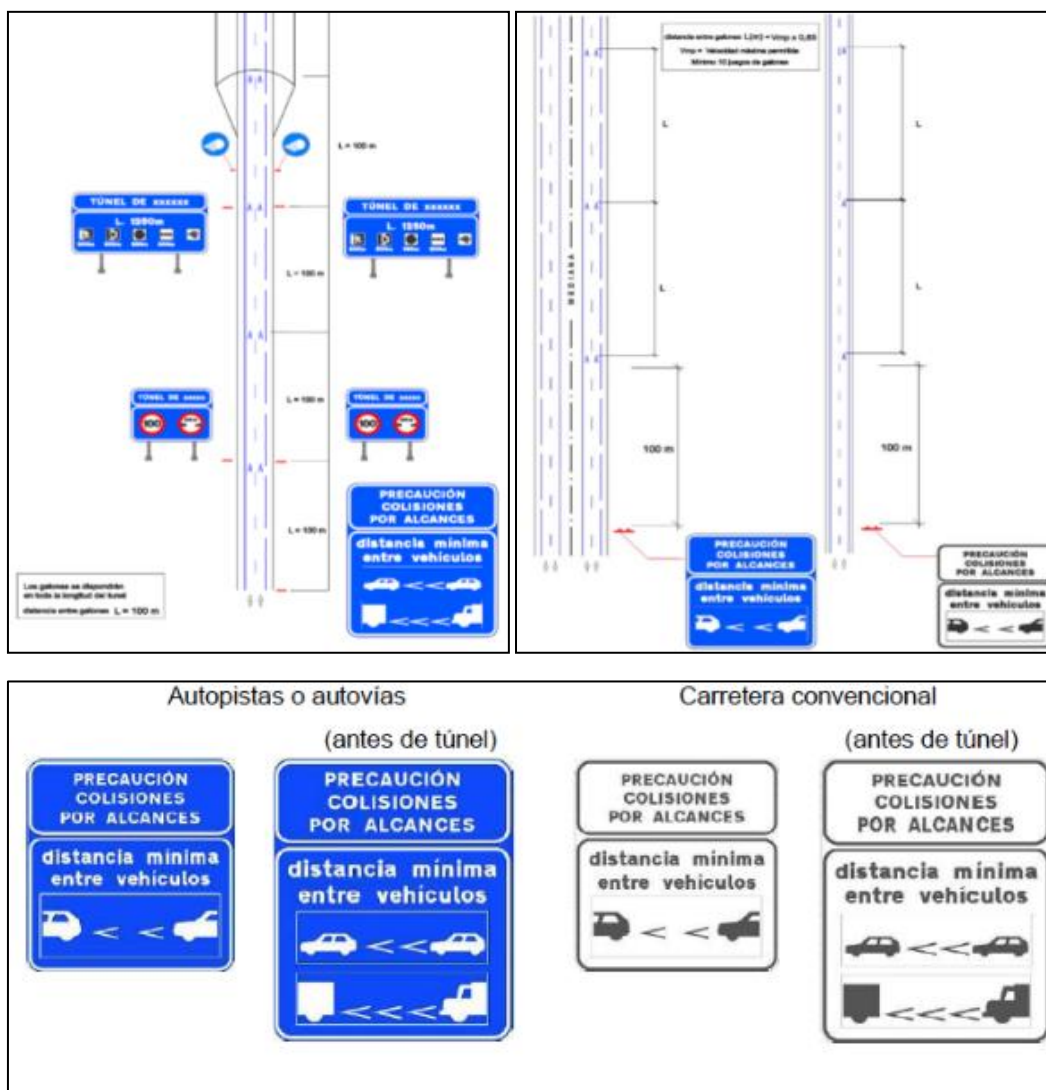

Figure 6.322 - Vertical signing of Road collision, according to the type of road (highways/motorways and ordinary roads)

#### ○ POLICIES

Before analysis carried out, a specific chapter called "Minimum distance between vehicles" was included in the Spanish Vertical Signing Standard (Norma 8.1-IC). This chapter indicates horizontal signing called "galón" (chevron) will be implemented in sections that a greater risk of accidents by scope (as it has been defined above). This standards establishes that it is necessary to accompany this horizontal signing with a vertical informative board whose characteristics and location are included in the aforementioned Spanish vertical signing standard.

Chevrons are expected to be included in the future revision of the Spanish Horizontal Signing Standard (Norma 8.2-IC). They are included in a draft which is currently under review. They are called M-7.12, "safety separation between vehicles."

#### ○ LESSONS LEARNED

If road and its surroundings conditions do not collaborate in the transmission of the message, regulatory signs are not always enough to warn all cases of risk situations. For this reason, it is necessary to study those particular cases in which accident records show the need to apply different solutions. These solutions must indicate clearly difference that causes accidents.

Another important fact is that drivers tend to pay more attention to horizontal signing inscribed on the pavement than to vertical signing. So, chevron reinforcement to the vertical boards achieves the complete transmission of the message.

The distance between chevrons established does not guarantee that in case of abrupt stop of the preceding vehicle there will not be a collision, because requirements are much higher.

#### ○ COSTS

In the standard case (considering an ordinary road locates near an urban area with 90 km/h as maximum legal speech), installation of road horizontal signing to indicate security distance between vehicles (safety clearance chevrons) in a 2 km road section approximately costs 3.000€. So, its average cost is 1.500 €/km.

#### ○ CONTACTS

Roberto Llamas Rubio

[rllamas@fomento.es](mailto:rllamas@fomento.es)

#### ○ REFERENCES

- [1] <http://www.fomento.es/NR/rdonlyres/cf15cac2-3612-4a60-99c5-974e2ad7fe8c/104461/11071902.pdf>



### 6.2.3.5. Narrowing of lanes in areas of reduced speed (crossings, etc.)

#### ○ COUNTRY

Spain

#### ○ IMPLEMENTATION ORGANIZATION

General Road Directorate of Fomento Ministry

#### ○ SUBJECT\* – PLEASE IDENTIFY WHAT SUBJECT/TOPIC THE CASE STUDY COVERS

This case considers narrowing of lanes as a measure to calm vehicle speed. A narrow cross-section induces drivers to reduce their speed because they have less margin to place their vehicle between the two lines that delimit the lane or between physical obstacles that are established (footwalks, traffic guidance equipment, central reserve, etc.).

The narrowing can be punctual in small sections of the road (from 5 to 10 meters in length) in which case it is necessary to have a physical element clearly visible by the drivers.

Even though, punctual narrowings separated from each other a maximum of 50 meters should be used to avoid drivers increase their speed when reduction affects a homogeneous section of a certain length (an urban area or a junction provided with central lanes for left turns). However, in this case, action will be able to be extended to the entire section if length is greater than 200 m. It is necessary an enough relative displacement of horizontal edge and axis signing (lane inside) too. Striped horizontal signing is necessary too because it defined areas excluded from traffic.



*Figure 6.323 - National road N-330. Entrance to urban zone of Jarafuel*

#### ○ PROJECT DESCRIPTION AND SUMMARY

The main Project target is to reduce speed in urban areas where it is not possible to carry out other measures to calm traffic at the entrance of this kind of areas (there is not enough place to construct a roundabout). In these areas transversal warning signs must not be installed because their noise would disturb inhabitants.

Adopted solution is narrowing lanes displacing longitudinal horizontal signing and creating areas excluded from traffic by striped horizontal signing.



Figure 6.324 - National road N-330. Urban zone of Jarafuel

Adopted solution consists on arranging two continuous parallel longitudinal lines on carriageway axis. These become discontinuous in the areas where turning movements are allowed. The marks have been arranged with a separation of 30 centimeters between them, without inner striped horizontal signing, because some tests considered that this kind of horizontal marking was suitable for separations equal to or greater than 50 cm.

It has been found that it is necessary that the narrowing is clearly noticeable by the drivers. Otherwise drivers do not reduce their speed sufficiently. Therefore, it is necessary to provide vertical signing that reinforce perception of the entrance to an urban area, such as village signing, maximum speed signing and warning of danger due to the presence of pedestrians signing. If the narrowing is strong, specific warning signing of this circumstance should be installed.



Figure 6.325 - P-17 vertical sign, narrowing on the road"

#### ○ KEY RESULTS/ACCOMPLISHMENTS

The main result is speed reduction in urban areas. This helped to reduce risk situations, especially if vulnerable users are considered.

#### ○ POLICIES

Study results have not led to new road safety policies. The updated version of the Standard 8.1-IC, of Vertical Signing (2014), incorporates in its chapter 7, on the maximum speed in different sections of roads, a section that considers more strict limitations in urban sections depending on the

distance between the edge of carriageway and buildings. However, it does not include values depending on lane width.

The results of the different studies carried out about measures to calm traffic in urban areas have been included in some publications and manuals. Some of them have even been presented at conferences on road safety, serving as a reference for road safety auditors in the supervision of projects, or as a possible solution for specialists who carry out study high concentration accident sections in urban areas.



*Figure 6.326 - Example of narrowing of lines*

#### ○ BARRIERS/OBSTACLES

The viability application of this kind of measures in urban areas depends on the characteristics of section where it is intended to act. Not all urban areas, and not in all zones of this areas there have space enough to carry out this kind of actions. It is sometimes necessary to apply another kind of measures to reduce speed (roundabouts in the entrances to urban zone, elevated pedestrian crossings, etc.).

Anyway, it is possible to combine different measurements according to the different zones of urban zone. However, it is necessary to carry out a detailed study of section characteristics, especially how transition zones between different parts of the section would be configured, as well as the distances between different measures.

#### ○ LESSONS LEARNED

Considering repainting horizontal signing by moving them into existing lanes, it is necessary to proceed milling of the old horizontal signing. If it is painted black on them, they may end up being visible depending on sun position.

An alternative is to build or extend footwalks on the outer edges of the roadway, complemented or not with shelters or islets in the center of the roadway. This solution entails the problem that a broken vehicle cuts off traffic, which does not happen in the case of the blindness of the areas excluded from circulation.

Another situation detected is that in the outer zones some drivers take advantage of space excluded from traffic to park their vehicles. It limits visibility and generates a risk near pedestrian crossings and junctions. In these areas it is considered appropriate to exclude them completely from use, so pavements can be extended or simply use traffic guidance elements to delimit them.



*Figure 6.327 - Example of traffic guidance equipment to avoid car parking in zones excluded from traffic*

○ COSTS

The cost of a lane narrowing action in a 2 km long is approximately 30,000-40,000 €, depending on the width excluded from traffic. To this it must be added vertical signing to reinforce this measure perception. It can vary between 3,000 and 5,000 €, depending on if conditions are remembered at regular intervals or not.

○ CONTACT

Roberto Llamas Rubio: [rllamas@fomento.es](mailto:rllamas@fomento.es)

○ REFERENCES

- [1] Calmar el tráfico. Pasos para una nueva cultura de la movilidad urbana. Alfonso Sanz Alduán. Edita: D.G. de Planificación; Centro de Publicaciones, Ministerio de Fomento. ISBN: 978-84-498-0822-7



### 6.2.3.6. *Signing and delineation of curves*

#### ○ COUNTRY

Spain

#### ○ IMPLEMENTATION ORGANIZATION

General Road Directorate of Fomento Ministry

#### ○ SUBJECT

One of the main targets of Fomento Ministry in Spain is to eliminate high concentration accident sections because they are sections in which objective risk of accident is abnormally high compared to similar sections.

So, periodically road safety specialists carry out detailed studies of each of these sections to define improvement actions that, predictably, can lead to an effective reduction of accidents.

In these studies, a high number of accidents were identified due to the exit of curves when the difference in safety speeds between consecutive elements was very high (heterogeneous layout). Therefore, this situation signing was analyzed when road and its surroundings characteristics do not allow to carry out local alignment improvements.

#### ○ PROJECT DESCRIPTION AND SUMMARY

The study starts from the need for drivers to adapt their circulation at all times to the characteristics of the road and the environment. All drivers are obliged to respect the speed limits established and take into account the characteristics and condition of the road and how many other circumstances concur at all times, in order to adjust the speed of your vehicle. However, in general, there are many drivers that circulate without paying due attention, so it is necessary to capture it by signing and traffic guidance elements.

In particular case of curves, road safety requires not to exceed a specific speed. Is a driver needs to reduce his approximation speed, he must evaluate situation with enough time not to break sharply and to be able to maintain control of the vehicle.

The use of traffic guidance equipment, warning signing of danger, signing of recommendation of the maximum speed, speed limit signs, or a combination of all these elements, should help the driver to take the right decisions to travel through the curve with the suitable speed for its characteristics.

So, indicators included in 8.1-IC Standard were revised in order to homogenize location of mentioned signing elements and traffic guidance equipment and their disposition depending on road characteristics. The new version of this Standard finished in 2014.

#### ○ KEY RESULTS/ACCOMPLISHMENTS

Road hazard markers are used as traffic guidance elements in curves. They are formed by a stripe plaque. They are made of white retroreflective material of class RA2 on a blue background color class NR, defined in the European standard. Signing of warning of danger in curves and the recommendation or limitation of the speed are included in the Spanish General Regulation of Circulation.



Figure 6.328 - Road hazard marker in curves

Road hazard markers are used in curves to help drivers to identify curve alignment (turning direction). Moreover, the first road hazard marker advises about dangerousness and it is simple, double or triple according to difference between approximation speed ( $V_a$ ) and recommended speed into the curve ( $V_2$ ). Depending on this difference, a simple, double or triple road hazard marker is installed, according the next table:

$V_a - V_2$	Panel	
Entre 15 km/h y 30 km/h	Simple	
Entre 30 km/h y 45 km/h	Doble	
Más de 45 km/h	Triple	

Figure 6.329 – Definition of the chevrons type based on the speed held by approaching the bend

Curve signing can be recommendation signing or speed limitation signing. Recommendations represent the speed that it is advisable not to exceed so that the sensation of discomfort of the occupants is not unacceptable, according to 3.1-IC Standard (called “Norma 3.1-IC, de Trazado”). Speed limitations are used when there is not enough visibility to stop an unforeseen obstacle, although it can be used in sections as a consequence of the detected accident rate, as is the case of the high concentration accident sections.

Adopted solution consists on installing a warning signal of danger in curves when the difference between approximate speed and curve speed is greater than 15 km/h. When this difference is greater than 30 km/h, it will be accompanied by a recommendation or speed limit signal with the value that it is advisable not to exceed.

A signing and traffic guidance equipment improvement in curves in the Spanish National Road Network has had an important effect because the number of run out accidents has been reduced in 55% and fatal accidents by night in 18%.

### ○ POLICIES

Road hazard marker location criteria are included in the 2014 revised version of 8.1-IC Vertical Signing Standard (called “Norma 8.1-IC”). It establishes some technical criteria for design and signing implementation in road projects

Resultant disposition is shown in the next pictures:

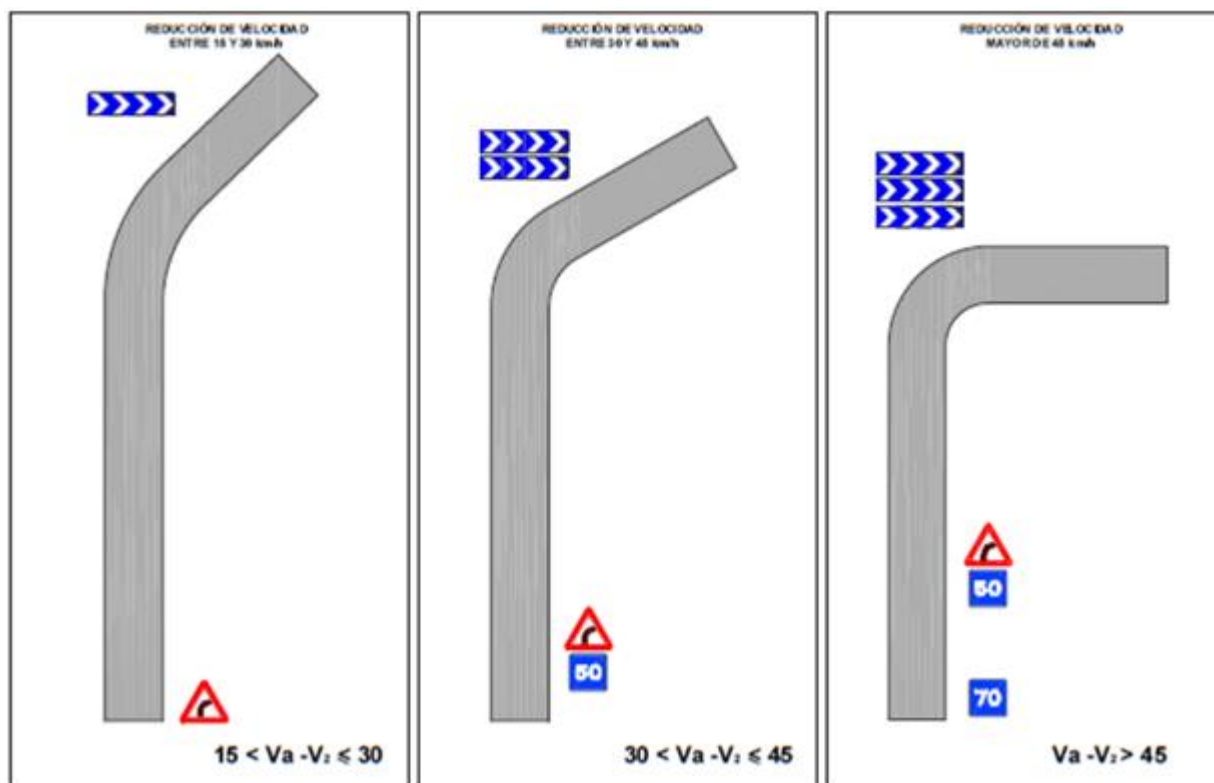

Figure 6.330 - Criterios de disposición de paneles

As it has been indicated, it is recommended to replace S-7 vertical signing (speed recommendation) with an R-301 vertical signing (maximum permitted speed).



Figure 6.331 – Left: S-7, vertical sign, Right: R-301, vertical sign

### ○ BARRIERS/OBSTACLES

The main problems derive from the placement of panels on existing roads because the arrangement of them. So, Spanish Standard (called “Norma 8.1-IC”) includes a chapter to establish their setting out on site, and some of recommendations for its correct placement.

### ○ LESSONS LEARNED

In addition to need for homogenization of signing and traffic guidance equipment in curves, studied carried out showed the need for homogenization of road hazard marker location. So, the next recommendations were established:

- Road hazard markers in curves are always arranged perpendicular to the driver.
- Road hazard markers are arranged along the curve. Their separation will be approximately one tenth of the curve radius, so that a driver can always see a minimum of three panels at the same time.
- Road hazard markers should be clearly visible, but only in the corresponding driving direction. It may be useful to group the panel placement in both directions, placing them at an angle.
- It will be checked that no obstacle prevents panel vision. If the impediment is a grade change, panel height on the road must be adjusted to be able to see it at least from a distance sufficient to adapt the approach speed to the curve speed.
- Vertical separation between the superimposed panels (placed at the beginning of the curve) will be 15 cm, because smaller distances can overlap panels vision and give the sensation of indicating that the curve is of the opposite direction



*Figure 6.332 – Example of implemented road chevrons*

### ○ COSTS

Installation of a set of road elements consisting on a warning signal of danger per curve (placed next to a signal of maximum speed) and 6 directional panels (all simple ones) costs approximately 1.800€ (considering both circulation directions).

### ○ CONTACTS

Roberto Llamas Rubio [rllamas@fomento.es](mailto:rllamas@fomento.es)

### ○ REFERENCES

- [1] <http://www.mfom.es/NR/rdonlyres/10C10CF6-54D9-4732-AE70-26D36268DF9D/124228/Norma81IC.pdf>



### 6.3. LOW- AND MIDDLE-INCOME COUNTRIES CASE STUDIES

#### 6.3.1. Case Studies dealing with Rural Corridors

##### 6.3.1.1. A case study of improving of visibility

○ COUNTRY

China

○ IMPLEMENTATION ORGANIZATION

Research Institute of Highway Ministry of Transport of China

○ SUBJECT

The case study covers the topic, potential countermeasures in Low - and Middle - income Countries.

○ PROJECT DESCRIPTION AND SUMMARY

This road is one section of the G322 in Zhejiang province. It is a part of the continuous curved sections with steep slopes and sharp turns. It locates in the mountainous and hilly area and also adjacent to the cliff. It is the 4th class highway with a poor visibility. Moreover, the signs and markings and other safety facilities are not perfect, as shown in Figure 6.333. Vehicles are prone to collision accidents when passing through this section.



*Figure 6.333 – The full view of the road before any measures*

The project was implemented in Dec 2016 and completed in Dec 2017. The purpose of the project is to improve the visibility, reduce the collisions, control the speed of vehicle and improve driving safety at night. The countermeasures includes the following aspects.

- Cut the mountain and build a horizon platform to improve the visibility, as shownFigure 6.334.



*Figure 6.334 - To build a horizon platform*

- Green the newly built horizon platform, as shown in Figure 6.335.



*Figure 6.335 - To Green the horizon platform*

Set up visual guiding devices and a convex mirror, etc. Widen and strengthen the shoulders. Set up class A w-beam guardrails on the side of the cliff with reflective visual guiding devices. Set the column delineator on the side of the mountain, as shown in Figure 6.336 ~ Figure 6.338.



*Figure 6.336 - To set guardrails, visual guiding devices, delineators, convex mirrors and other facilities*



*Figure 6.337 - The full view of the road after completion*



*Figure 6.338 - The visual effect after completion*

#### ○ KEY RESULTS/ACCOMPLISHMENTS

The measures have effectively improved the road safety and comfort when driving to sharp turn and steep slope section. The new horizon platform is integrated with the natural landscape. The construction of the horizon platform has effectively reduced the traffic conflicts in the poor visibility sections of the curved line. The marking, visual guiding devices, delineation and other devices enhance the road visibility and the night driving safety. The safety facilities such as guardrails can reduce the rate of the falling accidents.

The project team conducted observations after implementation. The observation point is facing the horizon platform, as shown in Figure 6.339. The project team observed the traffic flow passing through the road in both directions. The observation took one hour (16:00~17:00). The results are shown in Tab 1.



Figure 6.339 - Traffic flow observation

Vehicle Type	Car / downhill	Car/ uphill	Medium bus	Large bus	Heavy truck	Medium truck	Light truck/ downhill	Light truck/ uphill	Motor tricycle
proportion	33.73%	49.40%	1.20%	1.20%	-	1.20%	6.02%	3.61%	3.61%
Average speed (km/h)	45	31	31	25		41	43	27	29

Table 6.9 - Traffic flow Observations. Notes: The average speed records of the less proportion (e.g. medium bus, large bus, etc) doesn't distinguish directions.

After the implementation, the overall speed of the vehicle was improved. The speed of the vehicle in the downhill direction exceeded 40 km/h. The average speed of cars in the uphill direction was greater than 30 km/h and the average speed of small trucks is close to 30 km/h. The goal has been achieved.

#### ○ BARRIERS/OBSTACLES

It is a huge money to excavate and construct a new horizon platform for highways with limit funds. During the implementation process, it should take into account the actual road conditions, the roadside conditions and accident data properly, and discuss with the personnel from the departments of the road maintenance and traffic management, on the basis of extensive data collection, and then carry out an overall design of the road section and ensure the reasonable budget.

#### ○ LESSONS LEARNED

The construction of the horizon platform has effectively reduced the traffic conflicts in the poor visibility sections of the curved line. The new horizon platform can be integrated with the natural landscape. It is an effective method by using of the marking, visual guiding devices, delineation and other facilities to enhance the road visibility and the night driving safety. The safety devices such as guardrails can also reduce the rate of the falling accidents. When driving to sharp turn and steep



slope section, the combination of such measures will effectively improve the road safety and comfort.

○ COSTS

Construction of the horizon platform costs about RMB180,000 yuan. It costs about RMB 4000 yuan for the visual guiding devices. There is convex mirror with a price RMB 800 yuan. It costs nearly RMB228000 yuan for class A w-beam guardrails. The total cost of the intervention is about RMB412800 yuan.

○ CONTACT

Dr. Chengcheng TANG E-mail : [973939419@qq.com](mailto:973939419@qq.com)

### 6.3.1.2. A case study of separation of two-way traffic flow

#### ○ COUNTRY

China

#### ○ IMPLEMENTATION ORGANIZATION

Research institute of Highway Ministry of Transport of China

#### ○ SUBJECT

The case study covers the topic, potential countermeasures in Low - and Middle - income Countries.

#### ○ PROJECT DESCRIPTION AND SUMMARY

The project is a section of Line S210, located in Zhejiang province. It is a long downhill section with sharp turns, steep slopes and a limited sight distance, as shown in Fig 1. It is difficult to guarantee the stopping sight distance in case of emergencies. Large trucks are prone to brake failure and the driving speed is hardly to control. There is a residential area on one side of the road. Once the vehicle exits the road, it will cause a secondary accident. This section is the provincial black spot. There were 4 fatal accidents from 2011 to 2013. All of the accident vehicles are large trucks and the cause of the accidents is similar, vehicle mechanical failure (brake failure) and driver improper operation, when driving to the sharp turns. As a result, the vehicle rollover accidents occurred.



*Figure 6.340 - A full view of the road section before the implementation*

The purpose of the project is to achieve the separation of two-way traffic flow, avoid accidents and provide emergency shelter and buffer area for the vehicles. There are several works to be done.

- In accordance with local conditions, taking advantage of the existing concrete pavement, widen the effective road surface by 3.5m. Move the downhill lane outward and improve the sight distance. Change the single road center yellow line to a virtual canalization island filled with yellow diagonals. No vehicle allows to drive onto the solid lines or enter this area, as shown in Figure 6.341.



*Figure 6.341 - The wider lane and the new virtual canalization island*

- Based on road widening project, the existing concrete bump wall is moved outwards and the height of the concrete wall is increased. The bump wall with seat type foundation is integrated with the road shoulder wall. Put up the new type of guardrail and visual guiding devices to enhance the function of protection, alerting and guiding, as shown in Figure 6.342 and Figure 6.343.



*Figure 6.342 - The location of the concrete bump wall and visual guiding devices*



*Figure 6.343 - The crash barrier after the implementation*

#### ○ KEY RESULTS/ACCOMPLISHMENTS

After the project has completed, vehicles go along the indicated lines and no rolling on or crossing over the markings complying with the current traffic organization plan. In the virtual canalization island area, there are basically no driving onto or cross the solid line on both two directions. It is success to realize the two-way traffic separation. Moreover, according to the observations, although the downhill section, the vehicles are slower down, and the speed of car decreases more than trucks. It is shown that the above warning and guiding devices perform well.

#### ○ BARRIERS/OBSTACLES

In order to improve the protection level of the barrier, the existing concrete bump wall has been moved outwards and the height has been increased. Taking into account the actual conditions of the road section, the new type of rotating crash barriers has been added to enhance the protection and early warning. This barrier is used less in China. Although the cost of the whole measures is relatively high, the overall driving safety has been improved effectively.

#### ○ LESSONS LEARNED

1)After setting a virtual canalization island area, vehicles go along the indicated lines and no rolling on or crossing over the markings. It achieves the separation of two-way traffic flow. 2)There is residential area on one side of the road. If the accident truck crashes out of the road, it will lead to a serious secondary accident. The seat-type bump wall will prevent large vehicles to blow out. 3)Rotary crash barriers are less widely used in China. The barriers can provide early warning when enhancing protection.

#### ○ COSTS

It cost about RMB89000 yuan to widen the road. The unit price of the pump wall is about RMB3030 yuan per meter. The unit price of the rotary crash barriers is RMB2500 yuan per meter. Both the pump wall and the rotary crash barriers are about 200m. It costs RMB7500 yuan for AWT reflective rain line (RMB150/m<sup>2</sup>, about 50m<sup>2</sup>). it cost about RMB3700 yuan for vibratory marking (RMB140/m<sup>2</sup>, about 27m<sup>2</sup>). The total cost of the project is about RMB220000 yuan.

#### ○ CONTACTS

Dr. Chengcheng TANG E-mail : 973939419@qq.com



### 6.3.1.3. Emergency braking ramp on roads and highways

- COUNTRY

Mexico

- IMPLEMENTATION ORGANIZATION

Federal Roads and Bridges of Income and Related Services

Acronym in Spanish (CAPUFE)

- SUBJECT

Rural corridors (motorway)

- PROJECT DESCRIPTION AND SUMMARY

Within the Mexican countryside combine a series of mountain ranges, coastal plains and plateaus with varied climates and contrasting topography, which has led to the development of semi-desert, desert, forests, lakes in highlands and rainforests along 10 000 km of coastline (50% mountainous and hilly area, 30% upland plateaus and plains 20%). Hence, the design of roads is carried out under conditions that cause topographic high descending slopes and of significant length.

The AADT is 40 thousand vehicles with a 11% share of heavy vehicles (trucks). In these road section, around 40% of the total of road accidents is due to run-off-road using the emergency braking ramp.

The objective was reduce the severity of accidents caused by failure in the braking system of vehicles, especially heavy ones. The project is continues, it has implemented since 2010 up today.

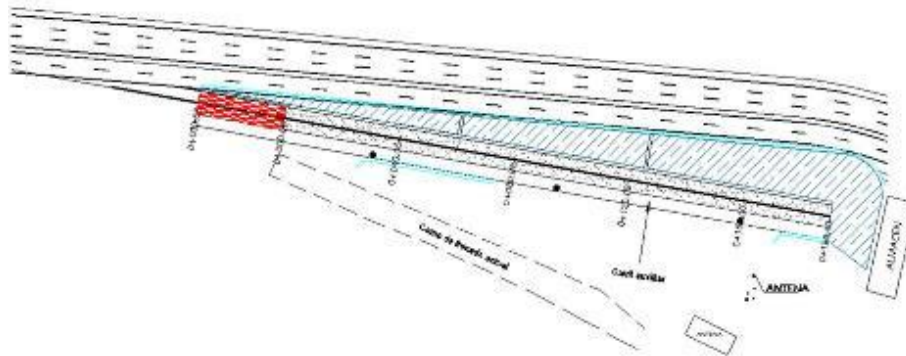

Figure 6.344 - Intervention design



Figure 6.345 - Before intervention



Figure 6.346 - Implemented intervention



Figure 6.347: operative conditions

○ KEY RESULTS/ACCOMPLISHMENTS

Seeks to demonstrate that this type of device is another example of why the authorities entrusted with the operation of the roads should be invested in road safety with this type of facility. The responsibility to design, build and maintain this device in good condition, with a clear and simple signal to guide the driver to the ramp; especially on the pavement marks in zone dense fog or heavy rain frequently.

○ POLICIES

Yes, the main policy were to generate and actualize the Official Mexican Standard (NOM-036-SCT2-2016) to established the criteria to design, build and maintain this device in good condition.

○ BARRIERS/OBSTACLES

The cost of this device is moderate, however, it's the main barrier to continue designing, building and maintaining this device on other sections motorways

○ LESSONS LEARNED

One conclusion is that the braking ramps should be part of the overall design of the roads, especially those with topographical conditions that cause high and descending slopes of significant length

○ COSTS

The approximate cost of new design and build was 650,000. USD

○ CONTACT

Emilio Mayoral, Mexican Transportation Institute, MEXICO: [emilio@imt.mx](mailto:emilio@imt.mx)

#### 6.3.1.4. Treatment of intersections in Route 9

○ COUNTRY

Uruguay

○ IMPLEMENTATION ORGANIZATION

Highways Agency-Ministry of Transport-Uruguay

○ SUBJECT

The subject presented is the modification of intersections in route 9 corridor, between route 8 and Chuy City, in order to reduce number and severity of accidents.

○ PROJECT DESCRIPTION AND SUMMARY

Route number 9 in Uruguay is an international freight corridor towards Brasil, and also a touristic road with traffic spikes in the summer months. This route is the main access to the oceanic resorts, and runs parallel to the Atlantic Ocean, with a main intersection on each resort.

The profile is rural undivided, with one 3.60m lane in each direction, and shoulders between 1.80 and 2.40m wide. The posted maximum speed is 90km/h, but measurements indicate higher values of the 85<sup>th</sup> percentile speed. On the section considered, there were thirteen main intersections with different typology, although the split roundabout was the predominant, giving priority to traffic flow on route 9. This intersection type presented problems from the road safety point of view.

The AADT was in 2016 of approximately 3700 vehicles, but the touristic character implicates that in the summer months this value duplicates, and the profile of drivers changes, which reflected heavily in accident statistics, mostly with head-on and lateral accidents in intersections.

This problem led to take action in the entire route by improving the intersections, standardize the typology and provide a foreseeable experience to the users of route 9 corridor, and carry out a specific research of the particular features of each point in particular.

The selection of the type of intersection: roundabout, was considered suitable as a general design, for its simplicity and ease of interpretation for all users, especially summer drivers, and because with a studied design it was able to accommodate heavy vehicles and passenger cars simultaneously.

The project comprised firstly an extensive literature review to define a general design. A range of documents were studied, such as “Roundabouts, an informational Guide”, NCHRP Report 672, FHWA-2010, “Kansas Roundabout guide”, “Roundabouts”, MoT British Columbia, relevant chapters from the DMRB, UK, AUSTROADS publications, combined with the previous experience at the national level with existing roundabouts. This review led to the integration of a multidisciplinary team to develop a general standard for the design of roundabouts, that included the pavement and geometric usual features, but also context-sensitive elements such as vegetation design to reinforce the guidance, signing, lightning project and others; all aligned with the concept of forgiving road and roadside.

In a period of less than three years, the project was fully implemented and roundabouts were materialized, with 0 fatalities or severely injured registered on the 13 remodelled intersections on



the corridor. It was considered important to implement the project simultaneously on the whole of route



*Figure 6.348 - Roundabout Route N° 9 and Route N° 8.*



*Figure 6.349 - Roundabout Route N° 9 and Route N° 37.*



*Figure 6.350 - Roundabout Route N° 9 and Route N° 39.*



*Figure 6.351 - Roundabout Route N° 9 and Route N° 104.*





*Figure 6.352 - Roundabout Route N° 9 and Route N° 15.*



*Figure 6.353 - Roundabout Route N° 9 and Avda Frade.*

○ KEY RESULTS/ACCOMPLISHMENTS

- Since the implementation of the Project there have been 0 accidents with fatalities or severely injured on the remodelled intersections in route 9.
- The Safe Systems Approach has been embraced, considering that the loss of lives in traffic accidents is not acceptable, even when accidents are related with the non compliance of traffic rules.
- Lessons have been learnt regarding the importance of leading projects with the main objective of improvement of safety conditions on the road.

- This experience was the start point of a process of continuous development in design of intersections in Uruguay, and the general standard defined has been adopted in other projects in the country.

#### ○ POLICIES

Standards have been adopted based on the literature review and analysis carried out:

- AASHTO's WB19 or WB20 with truck apron as the design vehicle.
- Study of access to surrounding land
- Vegetation design as part of the general design of roundabouts
- Specific design for vulnerable road users
- Integration of diverse aspects of the design (pavement, signs, lighting, etc. ) in the general design and not as parts added in later stages of the implementation.

Specific integration of road safety aspects for all users and not only for drivers in the general design.

#### ○ BARRIERS/OBSTACLES

- The project required full commitment of various areas within the Highways Agency and the Contractors, who worked with a very tight schedule in the design and construction of each intersection, as it was considered important to standardize the experience for users of the corridor.
- Funds needed to be allocated specifically for the implementation of the project.
- Efforts in the coordination within the different sectors in the Highways Agency, Local Authorities, Utilities Companies, etc were needed.

#### ○ LESSONS LEARNED

- Integration of specialists from diverse areas of knowledge.
- Integration of local authorities in the process of implementation.
- The importance of analyzing situations in particular, but within a context, for example to study the functioning of all intersections in a route, and not just the ones with a bad accident record.
- The importance of a good standard general design, to use broadly and adjust depending on the particularities of each case.

#### ○ COSTS

The approximate cost of the whole intervention was USD 7.300.00.

#### ○ CONTACTS

Ing. Adriana Varela, Ing Teresa Aisemberg

[adriana.varela@mtop.gub.uy](mailto:adriana.varela@mtop.gub.uy)

[anita.aisemberg@mtop.gub.uy](mailto:anita.aisemberg@mtop.gub.uy)



### 6.3.2. Case Studies treating Linear Settlements Studies treating

#### 6.3.2.1. *Setting of dimension stone pavement on highways through village*

○ COUNTRY

China

○ IMPLEMENTATION ORGANIZATION

Research Institute of Highway Ministry of Transport of China (RIOH)

○ SUBJECT

The case study covers two topics, setting credible speed limits(SCSL) and potential countermeasures in Low - and Middle - income Countries.

○ PROJECT DESCRIPTION AND SUMMARY

The road (Daxi Road) is located in the surrounding area of Beijing. It is the only way from the village of Xidamo to the outside world. There was no warning or speed control measure at the beginning of the village entrance. According to the observation, the average truck speed was about 30km/h and maximum was close to 50km/h. It leads to the occurrence of severe traffic accidents between the motor vehicles and non-motor vehicle, the motor vehicles and pedestrians.



*Figure 6.354 - Lack of warning and speed control measures*

The project was implemented in January 2007 and completed in December 2009. The main job is to lay the dimension stone pavement in the front of the entrance to the village of Xidamo, as shown in Figure 6.355.

The purpose of the project is to set up simple, economical and practical traffic safety facilities on rural roads in accordance with local conditions and local materials, so as to slow down the speed of motor vehicles going through the village and ensure the safety of pedestrians.

The use of simple traffic safety facilities on rural roads is a "frustration" option, and it is a compromise option to improve the level of traffic safety on rural roads under the constraints of low local economic and social levels. Based on the local conditions, in this case, it is a low-cost measure to set dimension stone pavement by making use of the stone along the road.



*Figure 6.355 - The dimension stone pavement section in the front of the entrance to Xidamo village*

○ KEY RESULTS/ACCOMPLISHMENT

After adopting these measures, the average speed of vehicle is reduced. The speed of the vehicle drops significantly when they approach to the dimension stone pavement section. However, after leaving the dimension stone pavement section, the speed of the vehicle increased to the level before the transformation, so it is recommended to set up the dimension stone pavement at the reasonable place to achieve the purpose of slower down the vehicle speed.

After the implementation of the project, the project team observed the traffic flow at the entrance of the village. Two sections (A1 and A2, 30 meters each) was denoted, as shown in Fig 3, the results are shown in Tab 1.



Figure 6.356 - Observing Plan

Vehicle	Loading	Quantity of samples	A1 section speed (km/h)			A2 section speed (km/h)		
			Highest	Lowest	Average	Highest	Lowest	Average
Medium Truck	None	10	45	24	33	49	25	40
Light Truck	None	4	33	21	26	58	48	54
Car		7	41	21	30	57	34	42
Motorcycle		1	20	20	20	21	21	21

Table 6.10 - Traffic flow observations

According to the previous data, the average speed of the medium trucks and cars was 37km/h and 41km/h. After laying the dimension stone pavement, when approaching to this section, the average speed of the medium trucks is 33km/h, a decrease of 11%; and the average speed of cars is 30km/h, a decrease of 27%. However, when leaving this section, the average speed of the medium trucks is 40 km/h, an increase of 8%; and the average speed of cars is 42km/h, an increase of 2%. Therefore, we suggest the dimension stone pavement should be set in the middle or back of the vehicle speed control zone, to make it sure that the speed control zone is somewhere approaching to the dimension stone pavement, so that it can effectively reduce the speed.

#### ○ BARRIERS/OBSTACLES

During the implementation process, the project team has solved some problems. 1)the size of the stone. The stones are too small to damage the ties. The stones are too big to fall off easily. 2)the thickness of the dimension stone pavement. It is too thin to slower down the speed of the truck. It is too thick to increase the loss of cars. When the speed of cars drops significantly, it can also cause



the collision with trucks easily. 3)the standardization of construction. The project team improve the standardization of simple traffic safety facilities so that such facilities can truly play their roles.

○ LESSONS LEARNED

It is dangerous to drive fast though the village, especially for the local residents. The average speed of vehicle is reduced after laying a dimension stone pavement at the entrance to the village. It has a significant impact on the speed of the vehicle approaching to the dimension stone pavement section, however, when leaving the section, it has almost no effect on the speed of the vehicle. This is mainly due to most of the drivers will accelerate once they pass the section. Therefore, we suggest the dimension stone pavement should be set in the middle or back of the vehicle speed control zone, to make it sure that the speed control zone is somewhere approaching to the dimension stone pavement, so that it can effectively reduce the speed.

○ COSTS

In this case, the construction cost of the dimension stone pavement is about RMB 380 yuan (less than USD 60 dollar) per square meters.

○ CONTACT

Dr. Chengcheng TANG 973939419@qq.com

### ***6.3.2.2. Arrangement of a turning point for vehicles at DN 28 km 65 + 400, in Valea Lupului locality, Iași county***

#### ○ COUNTRY

Romania

#### ○ IMPLEMENTATION ORGANIZATION

C.N.A.I.R. S.A. – D.R.D.P. IAȘI through S.D.N. Iași

#### ○ SUBJECT

The road sector on which the turning area for vehicles was arranged was rehabilitated between 2000 and 2003, the road being designed with four lanes, two on the way, separated only by road markings. As a result of the increase in traffic values of both transit traffic and traffic attracted as a result of the socio-economic growth inside the area, the number of collisions in the sector adjacent to this point increased, so an analysis of the events that have led to the need to improve safety by setting up a turning point for vehicles.

#### ○ PROJECT DESCRIPTION AND SUMMARY

The road sector DN 28 km 0 + 000 - km 68 + 170 was the object of the national roads rehabilitation works carried out during the period 2000 - 2003.

According to these works, the geometrical features of the cross section of the road were designed as follows:

- 2 lanes x 3.50 m each, one/direction
- 2 reinforced shoulders with the role of emergency lane x 2.50 m, one per each direction.

Also, the geometrical characteristics of the cross section of the road, on the km 65 + 170 km 68 + 050 were designed as follows:

- 4 lanes x 3.50 m each, two strips per direction
- 2 x 0.50 m shoulders, one for each direction.

At the time of finalizing the respective works, considering the road traffic data, including the pedestrians, which were the basis for the elaboration of the technical project, the traffic directions were not physically separated, through guard rails.

Between 2004 and 2009 there was a constant and strong growth of the local economy and the local conjuncture (the right side of the road was included in the urban area of Iași and the left side - inside the Valea Lupului commune) led to a massive urban development of the area in the vicinity of the national road. In this situation, there was a strong increase in the volume of traffic on the European road, reaching the first class of traffic (MMA>21,000 standard vehicles/day). Simultaneously with the economic development of the area, the urban growth also occurred, on the left side of the road being developed an important residential area. Taking into account the dynamics of road accidents from 2005 to 2009, it has proved necessary to reconsider the way of organizing the road traffic on the road sector inside the Valea Lupului commune.

The solutions that were adopted were the separation of circular traffic across the town by placing New Jersey concrete safety fencing with H = 1.00 m, width at the base being 64 cm. In the first

stage, the left turns were allowed only at the intersection in "T" at km 65 + 965, and at a roundabout intersection built at km 67 + 045, which was arranged for access to a nearby shopping area. Subsequently, since at the intersection of km 65 + 965 collisions continued to occur, separating barriers were placed at this point, and thus it became necessary to carry out an arrangement so that the traffic on the direction of Valea Lupului - Iași could make a safe return maneuver. Considering the existence of a drug factory that attracts a significant volume of traffic, it was proposed to build a roundabout junction at km 65 + 155 or at km 65 + 360.

Due to economic reasons, no such arrangements have been made yet. Therefore, for the provisional solution of the situation, a turning point was executed at km 65 + 400, so that traffic on the left side of DN 28 in Valea Lupului can be directed to Iași in almost safe conditions.

The location of the turning point was determined considering the surrounding area and the existing possibilities, so that the additional intervention is minimal - given the provisional nature, meanwhile it was starting the procedure of the design and built of the roundabout at the main entrance at ANTIBIOTICE SA – drugs factory.

The details of the arrangement of the return area, as can be seen in the attached diagram, are as follows:

- The width of the national road platform was increased in order to keep two lanes for each traffic direction;
- The length of the area where the changes were implemented = 210.00 m
- Left turn belt length = 15.00 + 40.00 m (constant width + variable width)
- Outside radius of turning curve = 12.00 m
- The traffic speed in the turning point area was limited to 30 km/h.



*Figure 6.357 – Before the intervention. Turning point top view*



*Figure 6.358 – Before the intervention. Road view before the turning point, section 1*



*Figure 6.359 – Before the intervention. Road view before the turning point, section 2*





*Figure 6.360 – Before the intervention. Road view at turning point. Example of car turning*



*Figure 6.361 – Before the intervention. Road view at turning point. Example of car turning back, phase 1*



Figure 6.362 – Before the intervention. Road view at turning point. Example of car turning back, phase 1



Figure 6.363 – Turning point after the intervention



Figure 6.364 – After the intervention. Road view before the turning point







Figure 6.366 – After the intervention. Turning point construction detail

○ KEY RESULTS/ACCOMPLISHMENTS

Period	Road sector	Collisions	Victims	
			Deceased people	Seriously injured
2005 - 2009	64+600 - 65+000	5	2	3
2010 - 2015		4	2	2
Total		9	4	5
2005 - 2009	65+000 - 66+000	9	4	9
2010 - 2015		1	0	1
Total		10	4	10
2005 - 2009	66+000 - 67+000	10	4	9
2010 - 2015		6	0	6
Total		16	4	15
2005 - 2009	67+000 - 67+900	5	5	6
2010 - 2015		3	1	2
Total		8	6	8
TOTAL 2005 - 2015	65+100 - 67+900 Length = 3.300 km	43	18	38

Figure 6.367 - The dynamics of road accidents on DN 28 inside the Valea Lupului commune is as follows



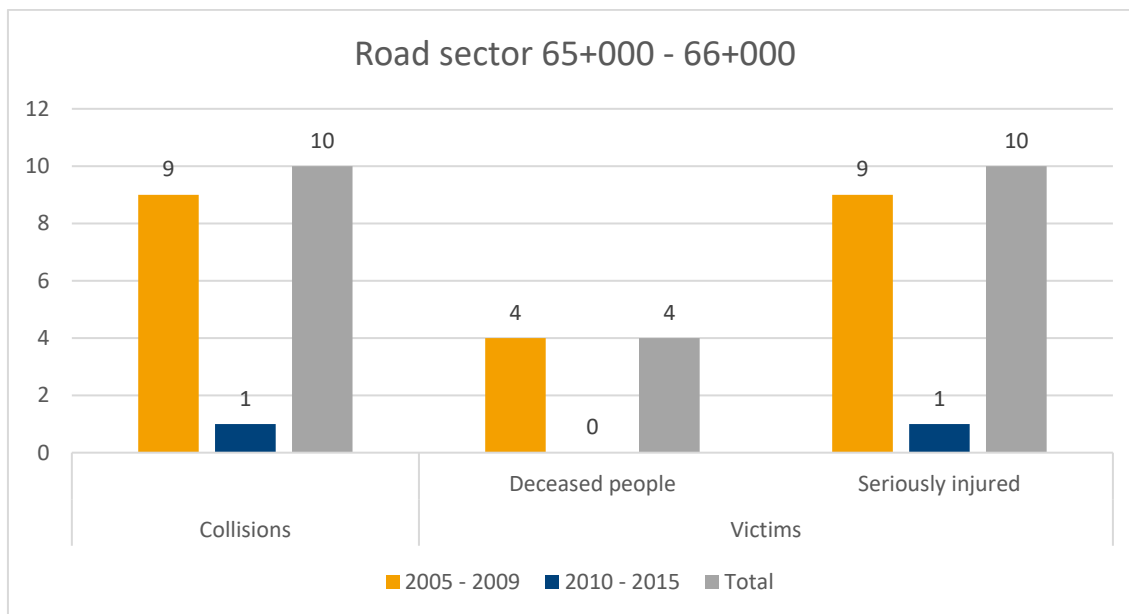

Graph 6.17 – Accidents statistics km 65+000 – km 66+000

Period	Road Sector	Collisions	Victims		Observation
			Deceased people	Seriously injured	
2005 - 2009	65+200 - 65+600	8	3	9	Turning point at km 65+400
2010 - 2015		1	0	1	
2005 - 2015	Length = 0.400 km	9	3	10	

Table 6.11 - information on collisions between 2005 and 2015

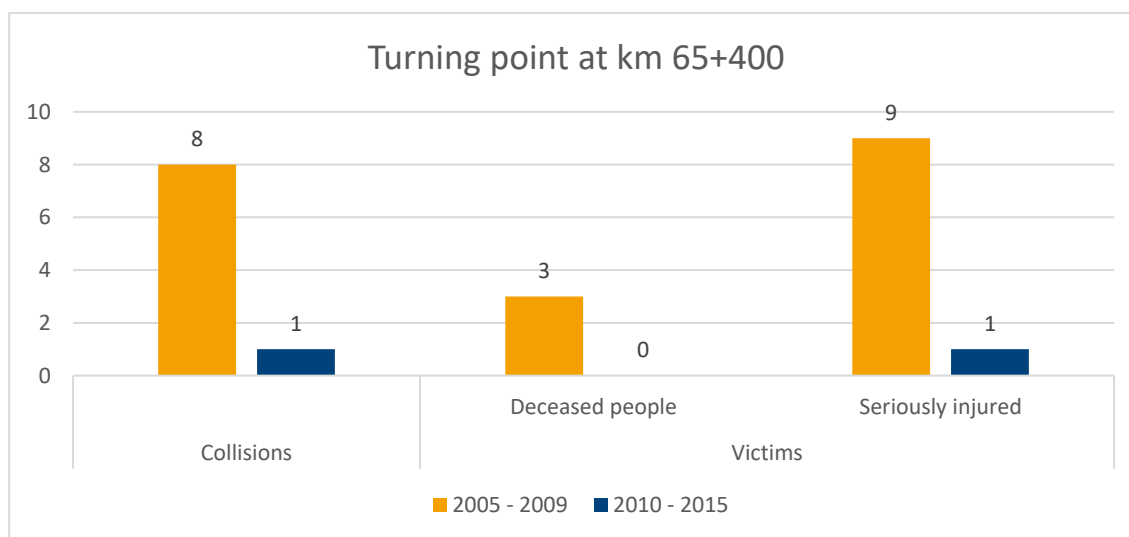

Graph 6.18 - Accidents statistics turning point km 65+400

#### ○ POLICIES

By realizing the respective arrangement, it was intended that the inhabitants of Valea Lupului commune, the vast majority of whom are former inhabitants of Iași municipality, could return in relative safety to Iași, where they learn, work or carry out the current activities during the day.

This vision has emerged as a result of the implementation of the separation of traffic from the four-lane sector, which has led to a drastic decrease in collisions occurring when uncontrolled maneuvers were made. The implemented solution was adopted following the supervision of the way the vehicle maneuvers were carried out as well as the behaviour of the drivers after the installation of the central parapets - the speed of travel in the crossing of the locality increased, which is also due to the impossibility of detection of exceeding legal speeds by radar police installed on cars traveling from the opposite direction.

#### ○ BARRIERS/OBSTACLES

In order to achieve this arrangement, it was necessary to cooperate very well between:

- Road Police as an institution responsible for managing road events and the one holding information on collisions produced in the area;
- the Regional Directorate of Roads and Bridges in Iași, together with the National Road Section of Iași, as the administrator of the respective road and responsible for ensuring safe traffic conditions;
- ANTIBIOTICE SA - as a traffic polarizing entity in the area and the main beneficiary of the roundabout intersection to be built nearby. In fact, it is this company that started the design and build procedure mentioned above.

This co-operation has, in some places, encountered some bureaucratic obstacles that have, however, been overcome by the benevolence of the actors involved.

Once the causes of the collisions have been established, through the cooperation process described above, the solution has been developed jointly and the implementation was carried out by R.D.R.B. Iași through N.R.S. Iași, after its approval by the Police Road Service Iași.

#### ○ LESSONS LEARNED

Both in the design phase of the rehabilitation works and later in the urban development of the area, no account was taken of the real increase of the traffic values in the DN 28 Valea Lupului - Iași sector, nor of the economic and social development, in the especially of the suburban area of Iași Municipality, so that the number of main intersections was not correctly dimensioned nor the way of arrangement of the existing ones at the initial stage when they were arranged only by specific markings and indicating loss of priority. As traffic has grown heavily as traffic has become more and more aggressive, it has become necessary to separate the traffic directions, together with the creation of places where the turning maneuver can be safely performed.

In order for such situations not to be designed in this way, we consider that it is imperative that at least all the major road works (national roads, county roads, communal roads), respectively rehabilitation works, capital repairs, modernization, building new roads, etc. to be thoroughly analyzed, including by carrying out the Road Safety Impact Assessment and Road Safety Audit, so as to identify and correct, from the feasibility study phase, the deficiencies that may lead to serious the operation of road infrastructure.

Thus, if the evolution of traffic in the Valea Lupului - Iași sector and the socio-economic increase of the adjacent area had been correctly estimated, it was possible to design, from the rehabilitation stage, safe intersections in sufficient number, to ensure that all necessary maneuvers are carried out safely.

○ COSTS

40.000 euros including VAT (approximate costs)

○ CONTACTS

Iulian-Cătălin Dimache

[catalindimache@yahoo.com](mailto:catalindimache@yahoo.com)

[catalin.iulian.dimache@gmail.com](mailto:catalin.iulian.dimache@gmail.com)

Ștefan Dinco

[stefd2005@yahoo.com](mailto:stefd2005@yahoo.com)

## 7. CONCLUSIONS

This report of case studies includes a series of implemented countermeasures or experiential proof of concepts to help improve road safety in a specific location or area. The case studies are from all over the world, demonstrating that many road authorities are now interested in vulnerable road user safety and in using human factors countermeasures.

As indicated in the report, many of these countermeasures have a transversal application by addressing issues specific to VRU and HF concurrently, sometimes within an acceptable context of LMIC (i.e. in respect with the level of investment).

However, while these case studies present potential solutions from several countries, there are relatively few from certain regions of the world such as Africa, Asia or South-America, or from LMIC. As such, the effectiveness of a specific case study will vary according to the local conditions, driving habits, traffic rules, regulations and/or signing and marking standards.

As a matter of fact, there was not enough data (before and after the implementation of the countermeasures) to generally assess the effectiveness of these solutions to improve the road safety.

For these reasons, these case studies should not be considered (yet) as “best practices” to solve specific road safety issues; they only represent a series of examples of how to address the matter. Engineers, planners and decisions makers of NRAs should interpret these case studies accordingly.

Finally, this is the first edition of the document, but TC C.2 objectives are to make this an ever-evolving document which can be continuously enriched with new case studies or with updated evidences of the implemented effective countermeasures. In particular, the input of more examples from low- and middle-income countries needs to be encouraged in order to make the document more universally relevant.



## 8. REFERENCES

- [1] PIARC, «Road Safety Manual,» 20 October 2019. [Online]. Available: <https://roadsafety.piarc.org/en>.
- [2] PIARC, «Road safety audit guidelines for safety checks of new road projects,» 2011R01EN, ISBN: 2-84060-199-0, 2011.
- [3] PIARC, «Road safety inspection guidelines for safety checks of existing roads,» 2012R27EN, ISBN: 978-2-84060-259-8, 2012.
- [4] PIARC, «Accidents Investigations Guidelines for Road Engineers,» 2013R07EN, ISBN : 978-2-84060-321-4, 2013.
- [5] PIARC, «Vulnerable road users: Diagnosis of design and operational safety problems and potential countermeasures,» 2016R34EN, ISBN : 978-2-84060-442-6, 2017.
- [6] PIARC, «Human Factor Guidelines for a safer Man-Road interface,» PIARC, publ. 2016R20EN, Paris, 2016.
- [7] PIARC, «Catalogue of Design Safety Problem and Potential Countermeasures,» PIARC, publ. 2009R07EN, 2009.
- [8] S. Birth, M. Pflaumbaum e G. Sieber, «Intelligenz System Transfer: HF-Training for Engineers,» Intelligenz System Transfer, Potsdam, 2006.
- [9] X. Cocu e E. Dumont, «Vulnerable Road Users diagnose of design and operational safety problems and potential countermeasures,» PIARC - World Road Association, 2016.
- [10] WHO, «Global Status Reports on Road Safety,» 2015.
- [11] ITF, «Road Safety Annual Report 2017,» OECD Publishing, Paris, 2017.
- [12] PIARC, «Improvements in Safe Working on Roads,» PIARC, publ. 2012R29EN, 2012.
- [13] S. Birth, B. Demgensky e U. Wähler, «Bericht zur Evaluation der Wirksamkeit einer optischen Bremse auf Geschwindigkeit und Unfallgeschehen 2010 – 2016 auf der B 158/A130 Leuenberger Grund,» Report für die Unfallkommission Märkisch-Oderland, Strausberg, 2016.
- [14] PIARC, «Human Factors in Road Design. Review of Design Standards In Nine Countries,» PIARC, publ. 2012R36EN, Paris, 2012.
- [15] Č. M., «Influence of human behaviour on geometric road design,» 6th Transport Research Arena April 18-21, 2016, Darmstadt, Germany, 2016.
- [16] M. C. Taylor, A. Baruya e J. V. Kennedy, «The relationship between speed and accidents,» TRL Report TRL511, 2002.
- [17] European Parliament; Council of European Union, «Directive 2008/96 EC of the European Parliament and of the Council of 19 November 2008 on Road Infrastructure Safety Management,» Official Journal of the European Union, November 29, 2008.
- [18] AASHTO, August 2018. [Online]. Available: <http://www.safetyanalyst.org/>.

- [19] AASHTO, «HSM - Highway Safety Manual,» AASHTO, 2010.
- [20] R. Elvik, «State of the art approaches to road accident black spot management and safety analysis of road networks,» Report 1 of work package 6 of the EU-project RIPCORDER-ISEREST (available on [www.ripcorder-iserest.com](http://www.ripcorder-iserest.com)), 2007.
- [21] EuroRAP, «British Results: Tracking collisions and road improvements, Monitoring motorcycle involvement, Benchmarking across Europe,» EuroRAP, 2015.
- [22] M. Sprunsen e R. Elvik, «Black Spot Management and Safety Analysis of Road Network - Best Practise Guidelines and Implementation Steps,» RIPCORDER ISEREST WP6, Deliverable D6, 2005.
- [23] Ministero delle Infrastrutture e dei Trasporti, «D.M. 137 02/05/2012 Linee guida per la gestione della sicurezza delle infrastrutture stradali ai sensi dell'art. 8 del decreto legislativo 15 marzo 2011, n. 35,» Ministero delle Infrastrutture e dei Trasporti, Rome, 2012.
- [24] European Commission, «RIPCORDER-ISEREST Project,» [Online]. Available: [https://ec.europa.eu/transport/road\\_safety/sites/roadsafety/files/pdf/projects/ripcorder-iserest.pdf](https://ec.europa.eu/transport/road_safety/sites/roadsafety/files/pdf/projects/ripcorder-iserest.pdf). [Consultato il giorno October 2018].
- [25] S. Birth, B. Demgensky e G. Sieber, «Relationship between Human Factors and the likelihood of single-vehicle crashes on Dutch motorways,» Report for Rijkswaterstaat Dienst Verkeer en Scheepvaart, Delft, 2015.
- [26] F. Zwieling, K. Reker e J. Flach, «Fahrerverhaltensbeobachtungen auf Landstraßen am Beispiel von Baumalleen. Eine Untersuchung mit dem Fahrzeug zur Interaktionsforschung Straßenverkehr. Berichte der Bundesanstalt für Straßenwesen,» Reihe Mensch und Sicherheit, Heft M 124, 2001.
- [27] M. Steyvers, «Morphing techniques for generating and manipulating face images,» Behavior Research Methods, Instruments, & Computers, 31, 359-369, 1999.
- [28] S. Birth, B. Demgensky e G. Sieber, «Human Factors Evaluation Tool 2017©,» Intelligenz System Transfer GmbH, Potsdam, 2017.
- [29] PIARC, Human Factors Guidelines for a Safer Man-Road Interface, PIARC, publ. 2016R20EN, 2016.
- [30] C. Burkhardt, «Fahrbahn, Fahrzeug und Fahrerverhalten,» Psychologie des Straßenverkehrs, Bern: Hans Huber Verlag, 1965.
- [31] A. S. Cohen, «Blickverhalten und Informationsaufnahme von Kraftfahrern,» Bericht zum Forschungsprojekt 8306/3 der BASt, Bergisch Gladbach, Nr. 168, 1987.
- [32] S. Birth e M. Pflaumbaum, «Human Factors in Road Design: a way to self-explaining roads. Validation of the IST-Checklist 2005,» Project Report of Work Package 3: Expert Assistance for Safety Review of Rural and Urban Roads (single carriageway roads).In: Ranking for European Road Safety (RANKERS) Research Project funded under the 6th Framework Program of the European Community, 2006.
- [33] PIARC, «Road Safety Manual,» PIARC, 2003.
- [34] PIARC, «CATALOGUE OF CASE STUDIES - Road safety improvements relevant to vulnerable road users, human factors and low and middle income countries,» PIARC, being published.

- [35] E. Hauer, «Observational before-after studies in road safety,» Pergamon, Oxford, U.K., 1997.
- [36] S. Birth, B. Demgensky e D. Reussner, «Bericht zur Evaluation der Wirksamkeit einer Stoppersäule auf Schulwegen im Landkreis Potsdam-Mittelmark,» Report für die Unfallkommission Potsdam-Mittelmark, Bad Belzig, 2015.
- [37] S. Birth, H. Stadt e O. Sporbeck, «Guideline for optical orientation by planting, (HVO),» Ministry of Infrastructure and Regional Development, Brandenburg, 2002.
- [38] M. Sorensen, «Grå strækninger i det åbne land - Udvikling, anvendelse og vurdering af alvorlighedsbaseret metode til udpegning, analyse og udbedring af grå strækninger,» PhD-thesis, Traffic Research Group, Aalborg University,, Aalborg, 2006.
- [39] The World Bank, «World Bank Country and Lending Groups,» 2018. [Online]. Available: [https://datahelpdesk.worldbank.org/knowledgebase/articles/906519#High\\_income](https://datahelpdesk.worldbank.org/knowledgebase/articles/906519#High_income). [Consultato il giorno October 2018].
- [40] UNRSC, «Global Plan for the Decade of Action for Road Safety 2011-2020,» World Health Organization, Geneva, 2011.
- [41] S. Birth, G. Sieber e H. Stadt, «Strassenplanung und Strassenbau mit Human Factors. Ein Leitfad.,» Ministerium fuer Infrastruktur und Raumordnung. Abt. 5, Strassenwesen, Strassenverkehr, Potsdam, 2004.
- [42] ITF, «Road Safety Annual Report 2016,» OECD Publishing, Paris, 2016.
- [43] NHTSA, «Traffic Safety Fact 2015,» 2017.
- [44] PIARC, «Setting Credible Speed Limits Case Studies Report,» 2019R26EN, ISBN : 978-2-84060-560-7, 2019.

## 9. GLOSSARY

Term	Definition
SM	Speed Management
VRU	Vulnerable Road Users
HF	Human Factors
LMIC	Low and Medium Income Countries
WG	Working Group
TC	Technical Committee
NRA	National Road Authorities

*Table 9.1*





*Copyright by the World Road Association. All rights reserved.*

*World Road Association (PIARC)*

*La Grande Arche, Paroi Sud, 5e étage, F-92055 La Défense cedex*

*ISBN 978-2-84060-604-8*